

VOL. XXXVII No. 2

FEBRUARY 1952

MECCANO

MAGAZINE



A "CAT-CRACKER"

9^D

DINKY TOYS

TRADE MARK REGD.



Dumper Truck
No. 562
8/8



Articulated Lorry
No. 521
7/5

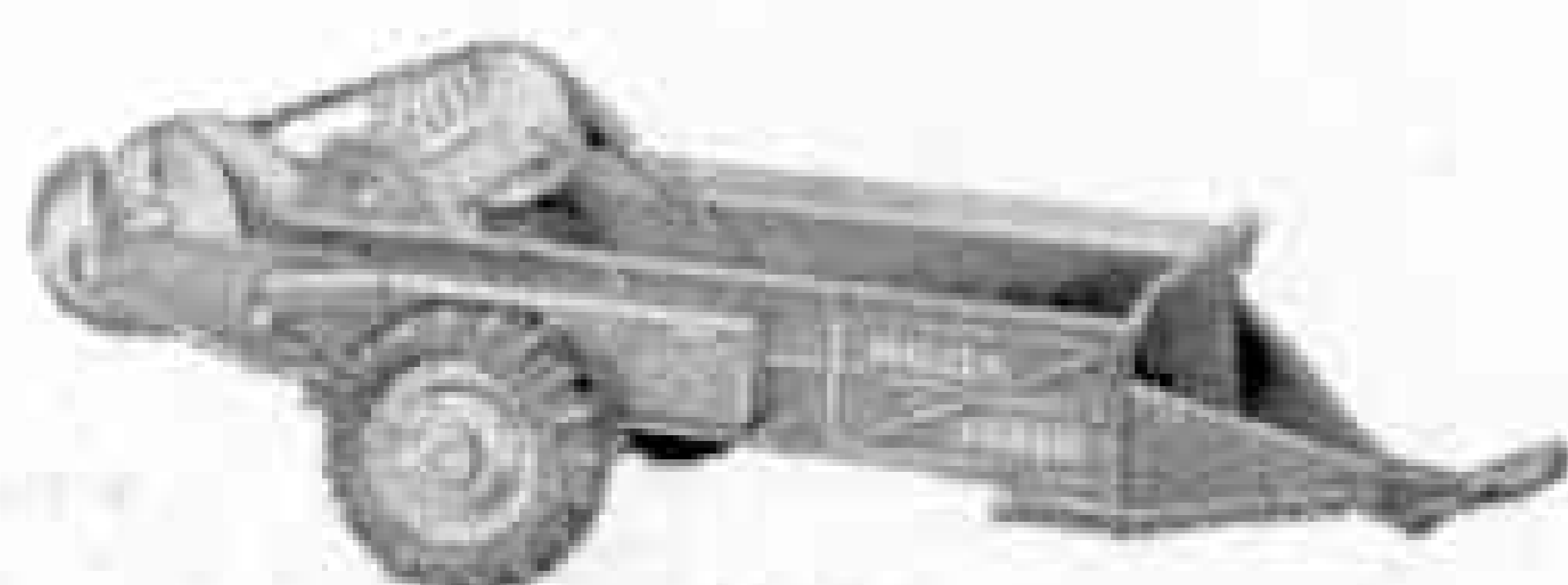

Massey-Harris Manure
Spreader No. 27c
4/9



Riley Saloon
No. 40a
2/11

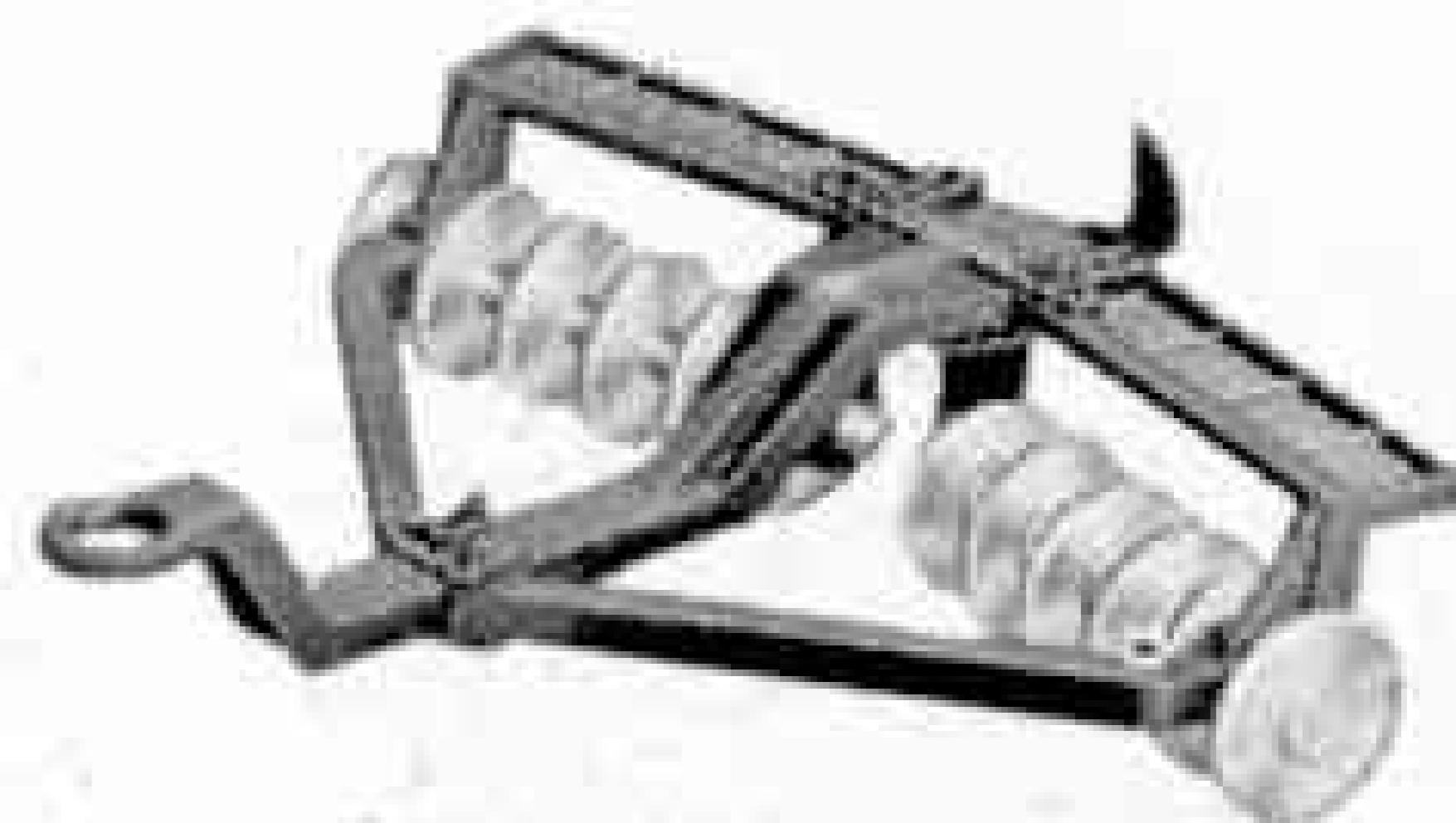

Disc-Harrow
No. 27h
2/9



Ford "Fordor" Sedan
No. 139a
3/1

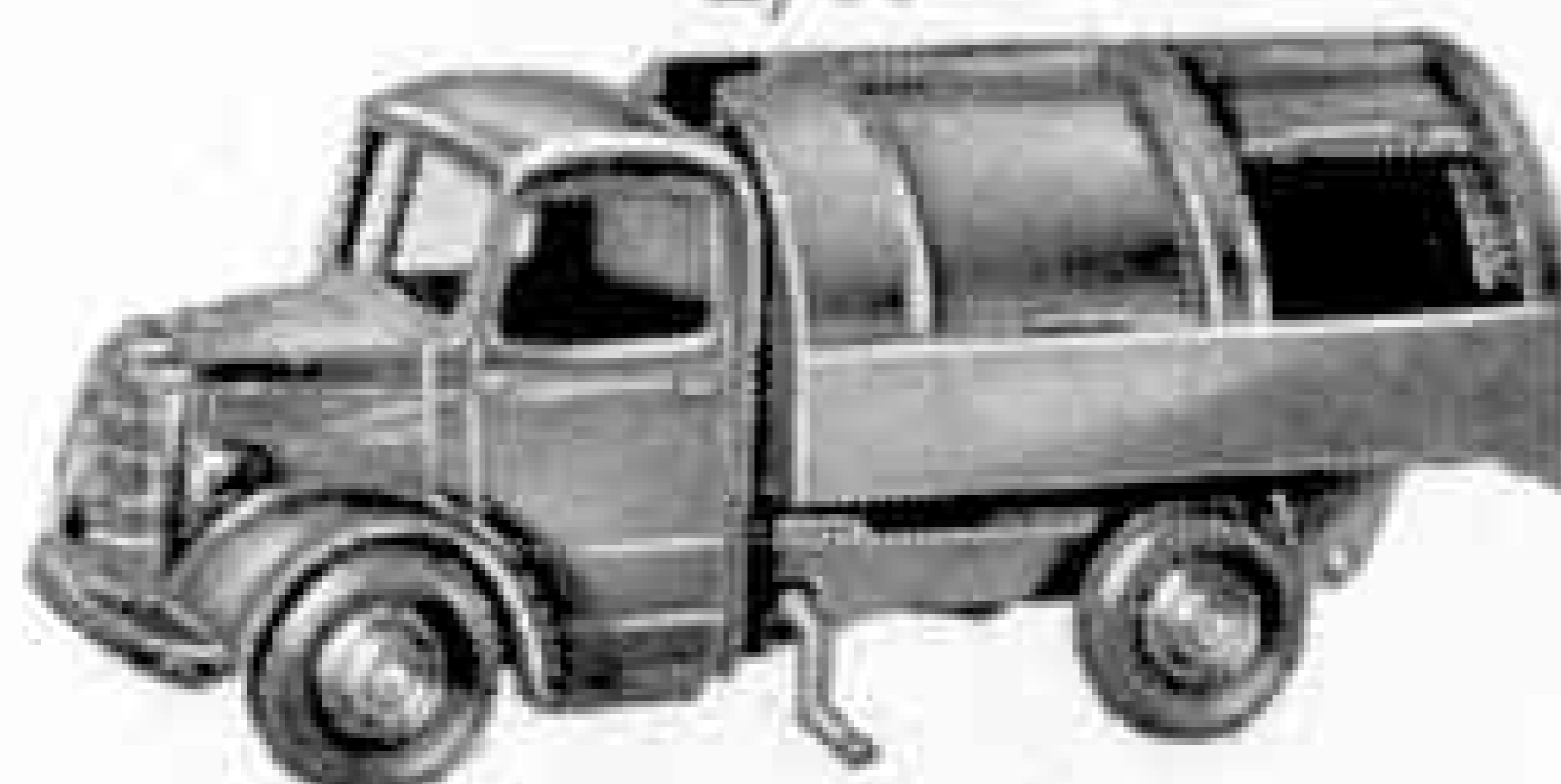

Refuse Wagon
No. 25v
7/2



Rover 75 Saloon
No. 140b
3/9



Motocart
No. 27g
5/3



Coventry Climax Fork
Lift Truck No. 14c
8/1



Austin "Atlantic" Convertible
No. 140a
3/11

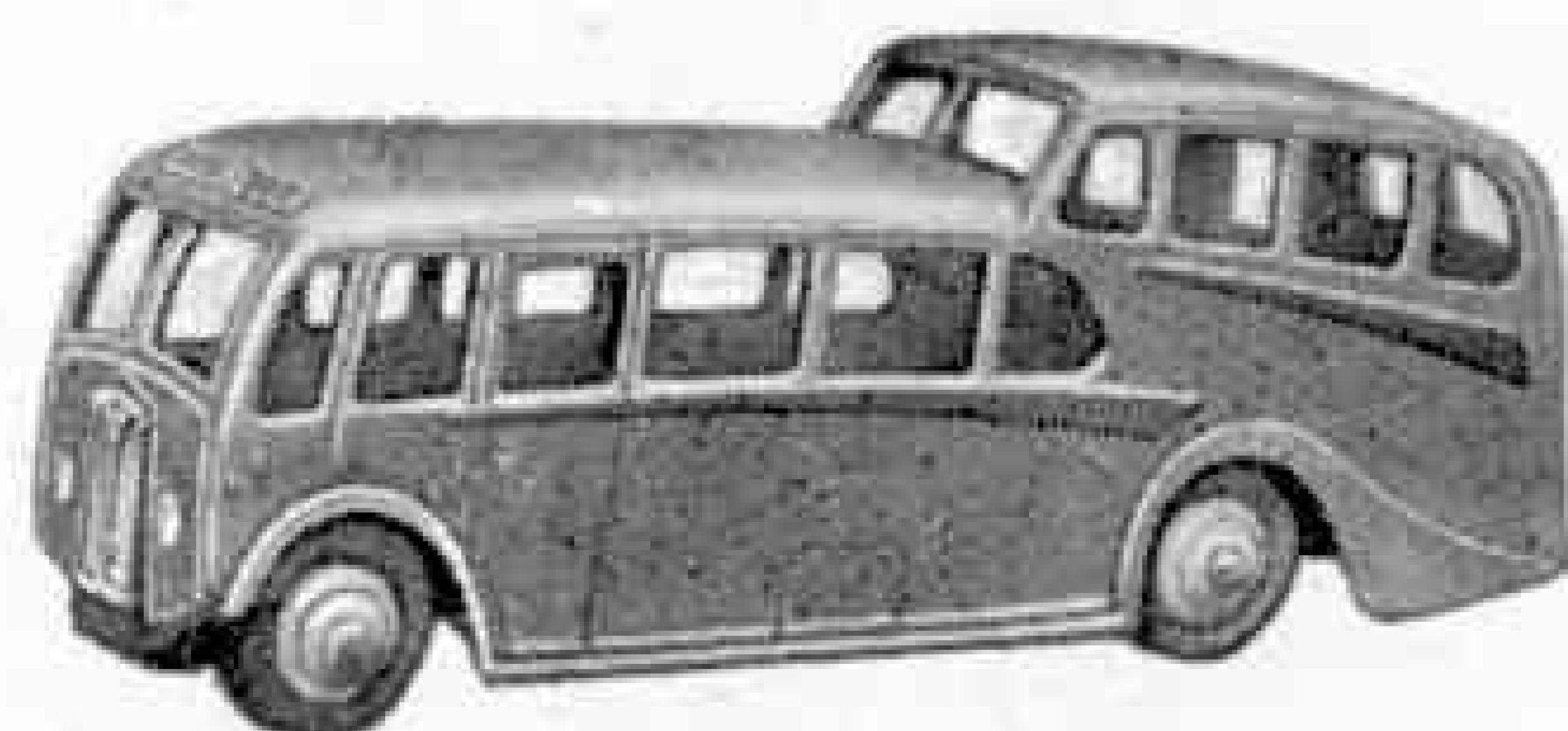

Observation Coach
No. 29f
3/11



Foden Diesel 8-wheel
Wagon No. 501
9/11

Prices include Purchase Tax

Keep the wheels turning. Tyres for Dinky Toys can be obtained from your dealer

MADE IN ENGLAND BY MECCANO LIMITED

DINKY TOYS

TRADE MARK REGD.

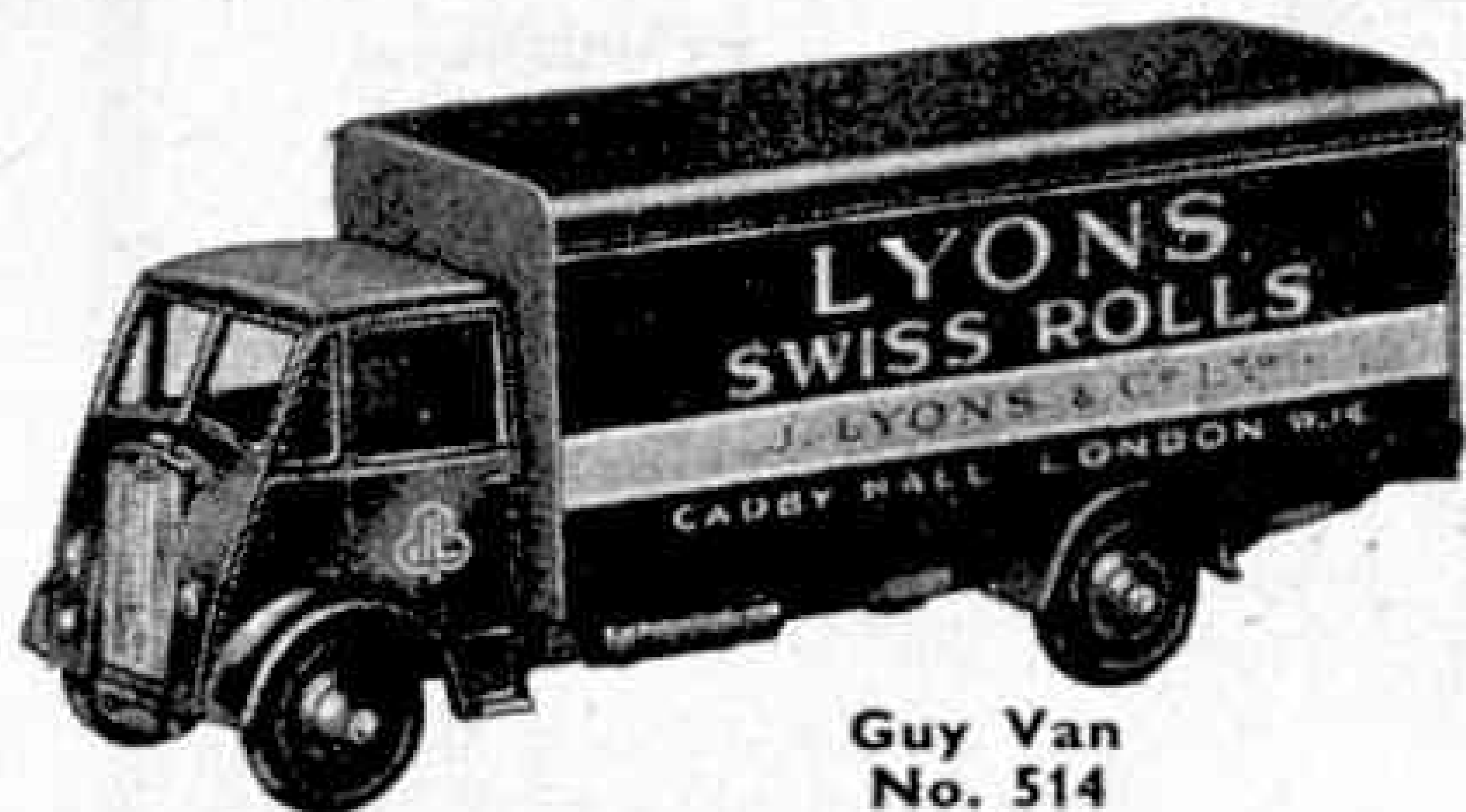

Guy Van
No. 514
7/9



Comet Wagon with Hinged
Tailboard No. 532
7/9

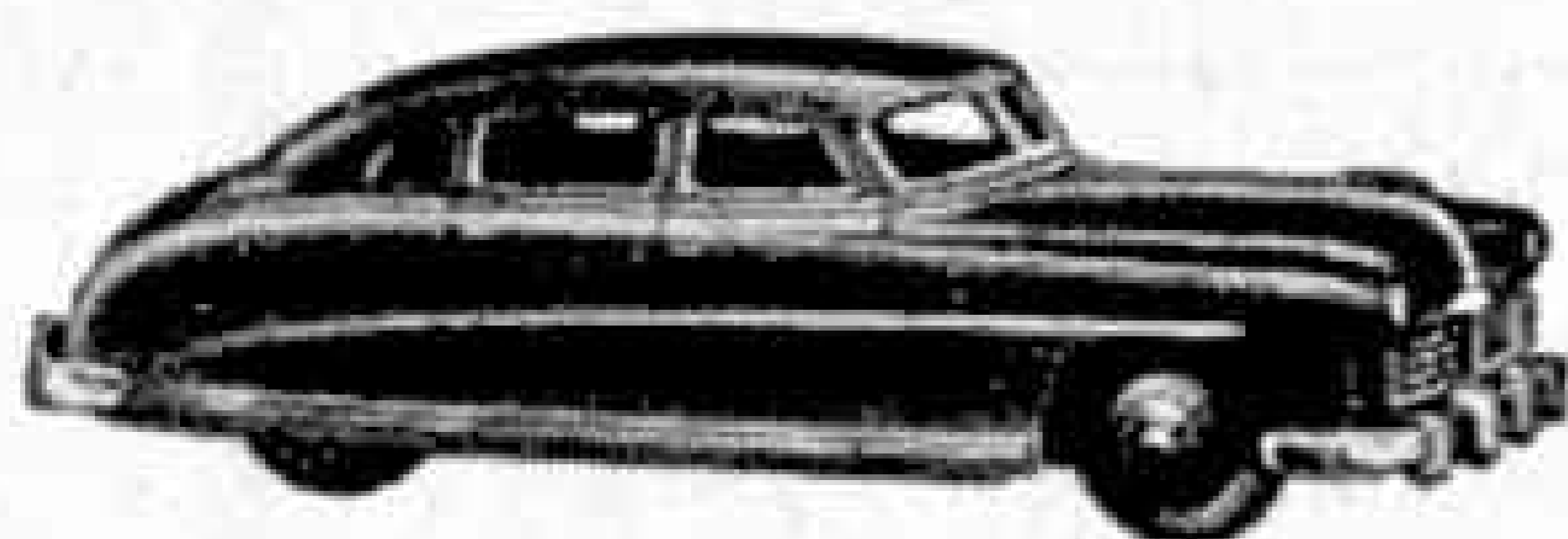

Hudson
"Commodore" Sedan
No. 139b
3/9



Land Rover
No. 27d
4/8

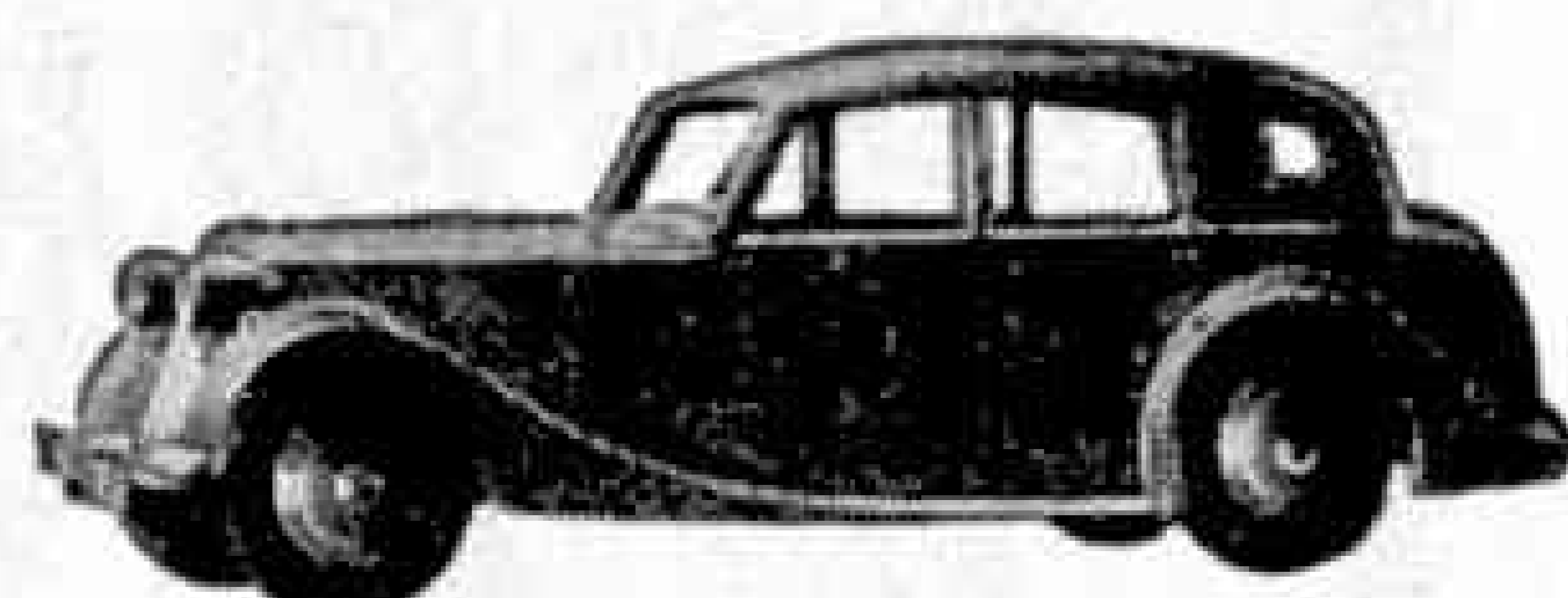

Triumph '1800' Saloon
No. 40b
2/11

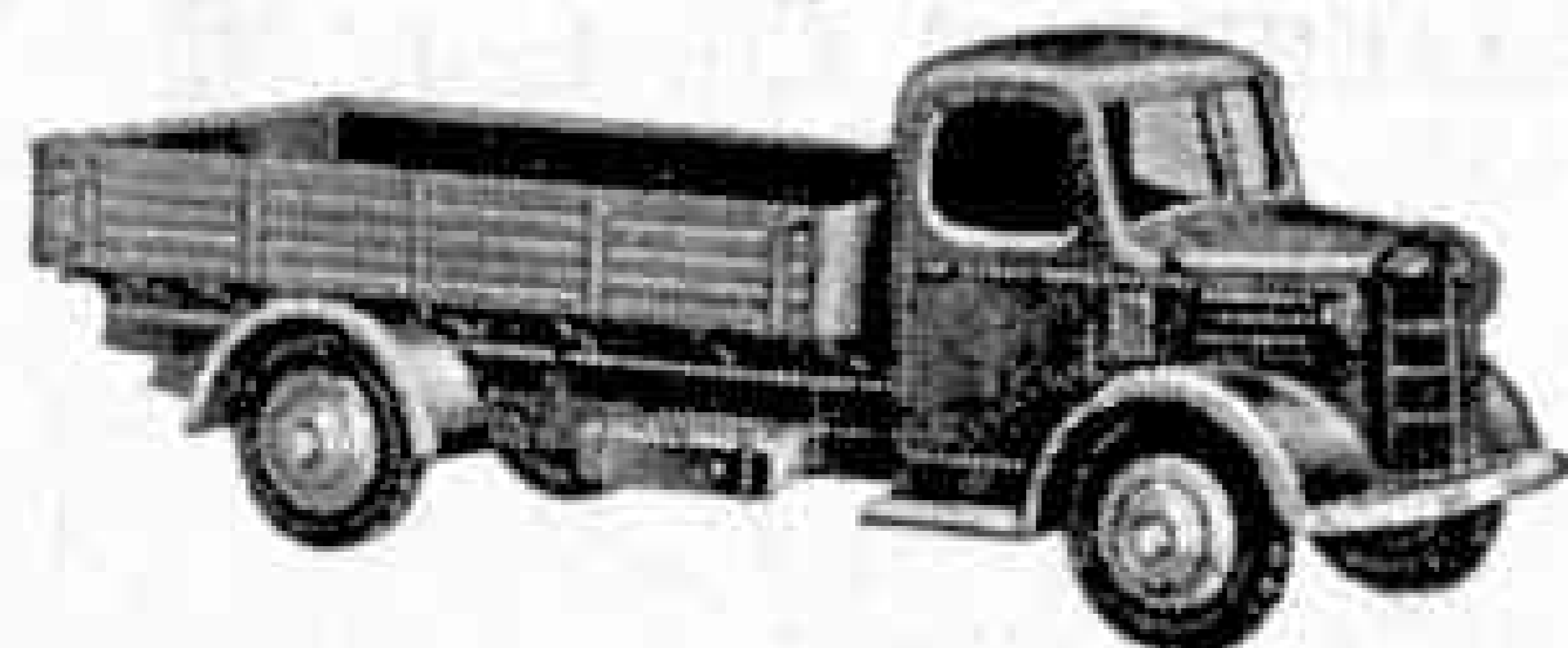

Austin Wagon
No. 30j
2/11



Austin Taxi
No. 40h
3/10



Breakdown Lorry
No. 25x
6/6

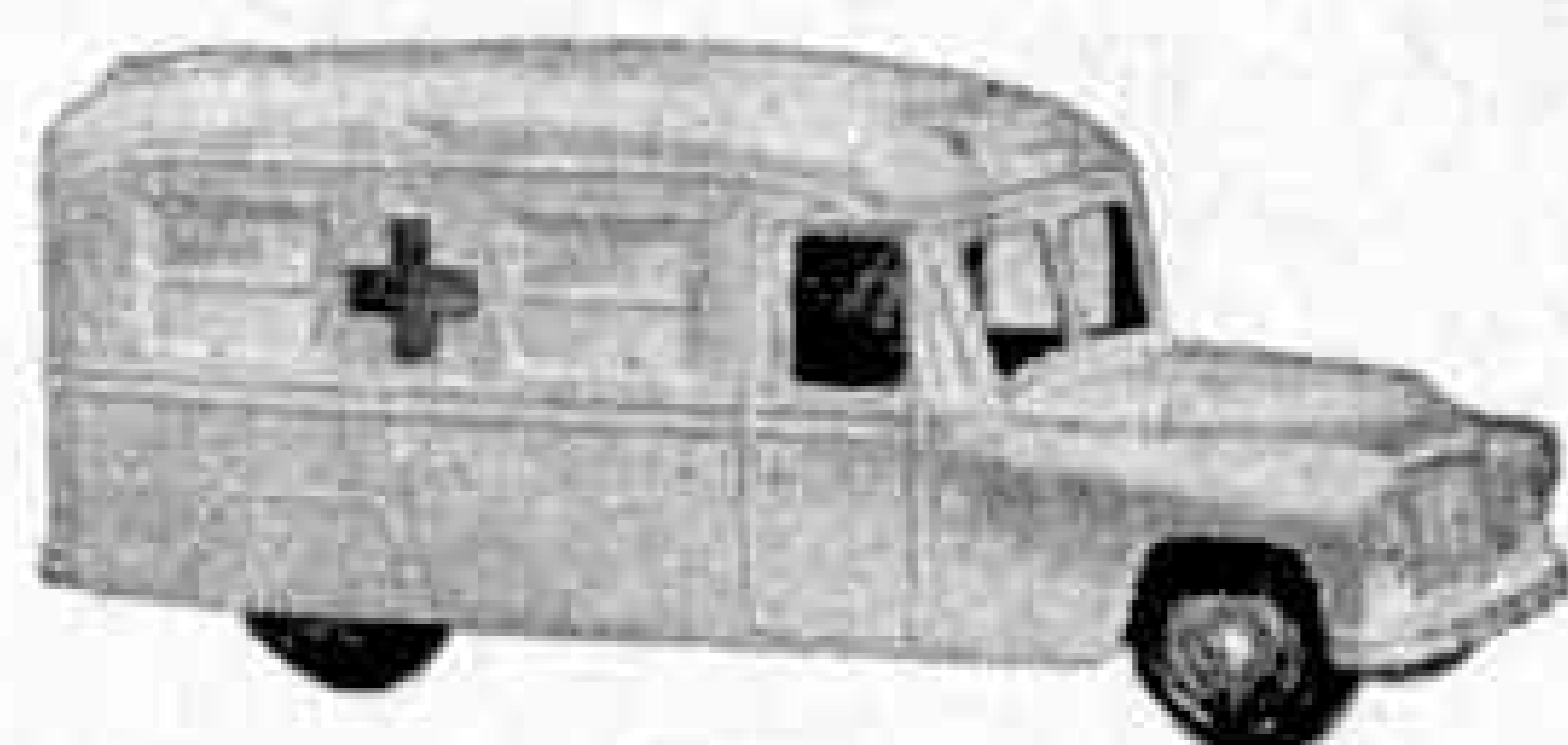

Daimler Ambulance
No. 30h
3/5



Estate Car
No. 27f
3/5

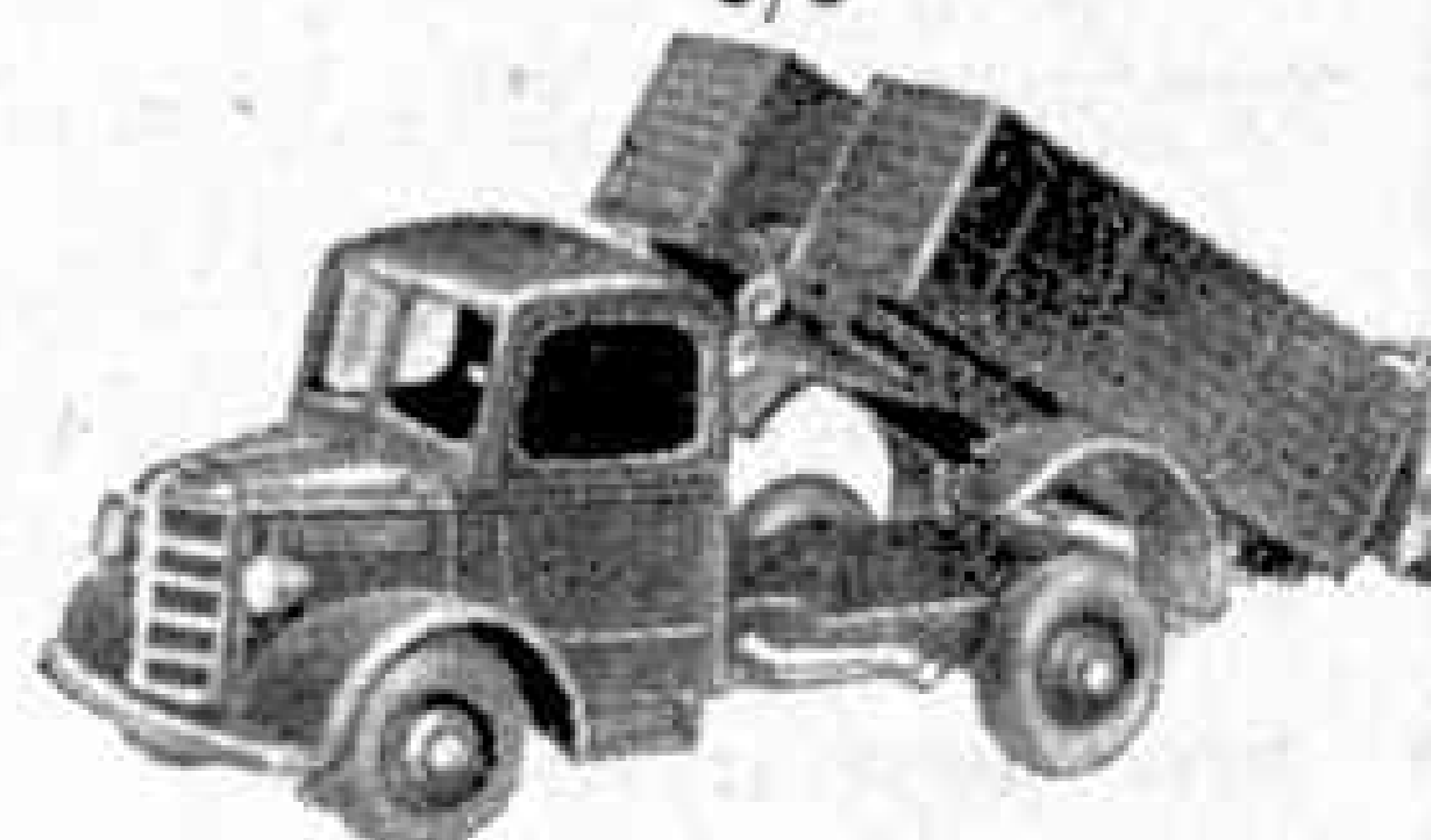

Bedford End Tipper
No. 25m
5/11



Foden Flat Truck with Chains
No. 505
11/6

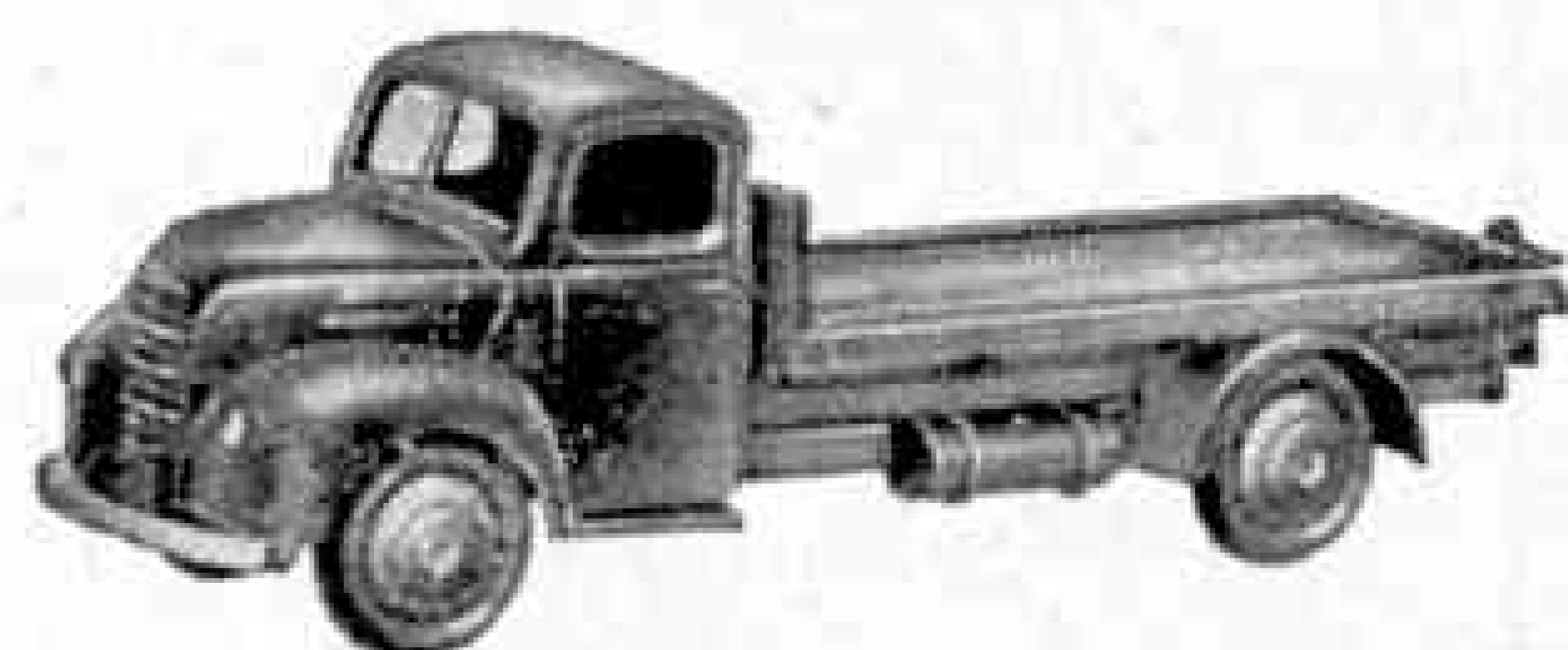

Fordson "Thames" Flat Truck
No. 30r
2/11

Prices include Purchase Tax

Keep the wheels turning. Tyres for Dinky Toys can be obtained from your dealer

MADE IN ENGLAND BY MECCANO LIMITED

*Build your own-
Railway Station.*

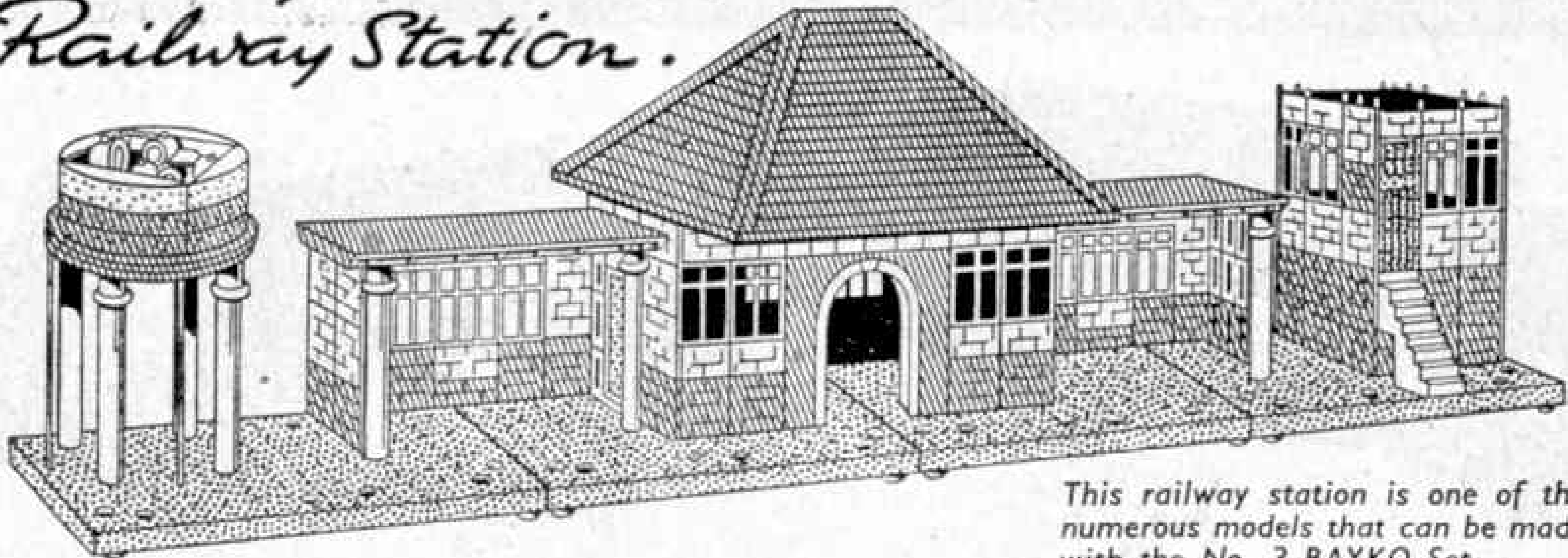

This railway station is one of the numerous models that can be made with the No. 3 BAYKO Set.

ASK YOUR
DEALER FOR
DETAILS OF

BAYKO
REGISTERED TRADE MARK
the Original Plastic
BUILDING SETS

PRICES:

No. 0 .. 15/-	No. 0x .. 7/6
No. 1 .. 22/6	No. 1x .. 15/-
No. 2 .. 37/6	No. 2x .. 22/6
No. 3 .. 59/-	No. 3x .. 60/-
No. 4 .. 118/9	

Made from richly coloured, high-grade plastic material, BAYKO is beautifully finished, easily cleaned and will survive years of hard treatment.

**PLIMPTON ENGINEERING Co. Ltd.
GIBRALTAR ROW, LIVERPOOL 3**

FOR EXPORT ONLY

What disappointments we had for five or six years. Everything good, everything desirable going abroad in exchange for dollars.

but now available—
TO YOU

1. A hand-built scale model goods Railway Set. £11-11-0
2. The most perfect passenger, main line Railway, built by experts, and a delight to look at. Powerful, strong and economical. £24-3-0

Illustrated brochure on request

Export enquiries invited

LEEDS MODEL CO. LTD.
30, DEWSBURY ROAD, LEEDS
— ENGLAND —



Genuine **HARBUTT'S**
"PLASTICINE"
MADE IN ENGLAND

There is only one 'Plasticine'—made solely by Harbutt's Plasticine Ltd. You will find 'Plasticine' invaluable for adding the touch of realism to your models. For prototypes 'mock ups' and other uses there is no more practical medium than

'Plasticine'

Sole Manufacturers. **REGD.**
HARBUTT'S PLASTICINE LIMITED
BATHAMPTON, BATH, SOMERSET

HEAD for SUCCESS with

BRYLCREEM

Smart, clean, well groomed hair puts heart into a fellow, makes him feel on top of the world. That's why men of achievement take good care to use Brylcreem. They know that where personal appearance counts only the best will do—and the best is Brylcreem. It's the perfect hairdressing. Brylcreem comes in easy-dip, easy-grip tubs 1/8, 2/6, and 4/6 or handy tubes 2/6.

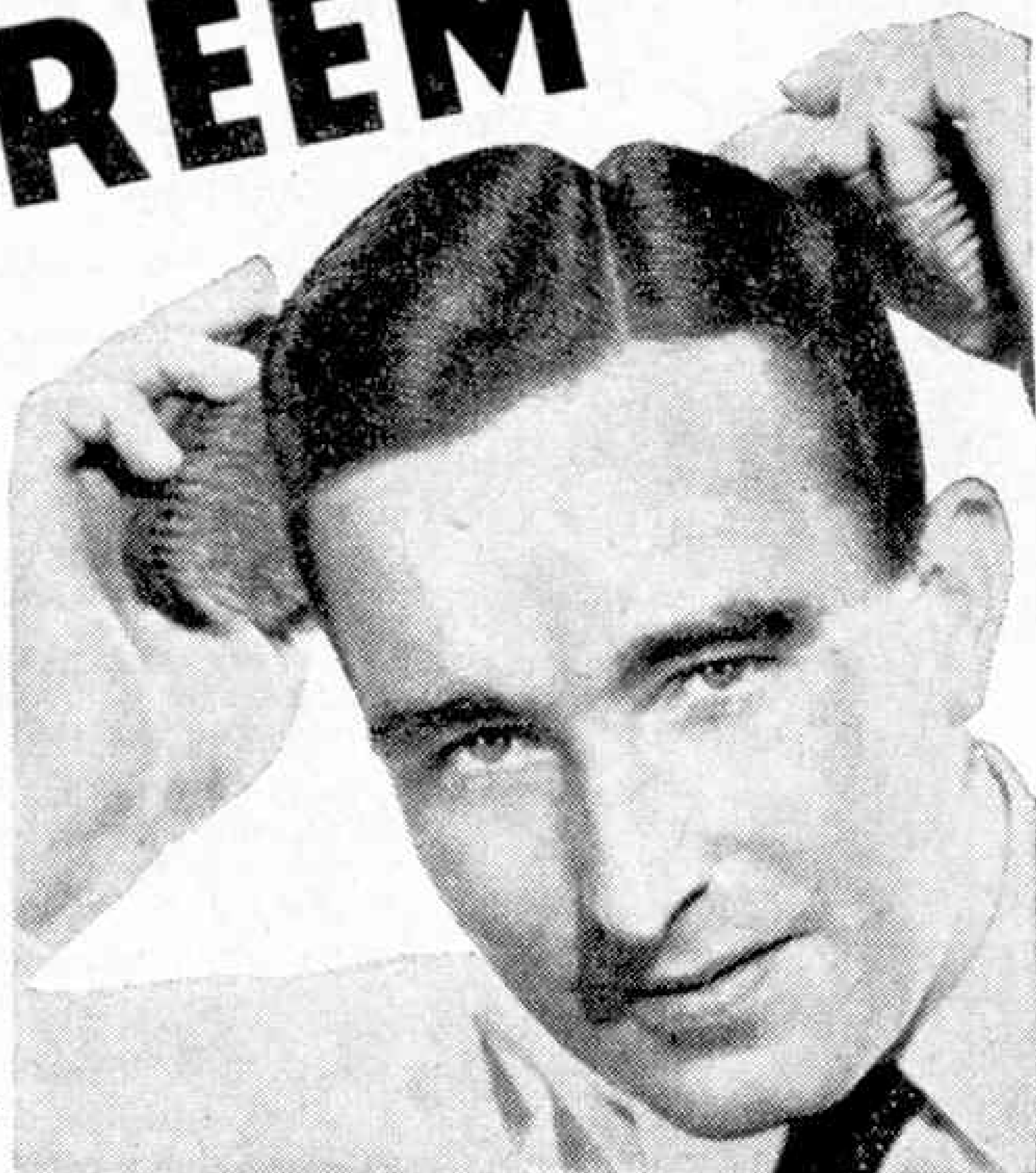

BRYLCREEM your hair

royds 71/38

ANOTHER 'M.S.' SMASH HIT

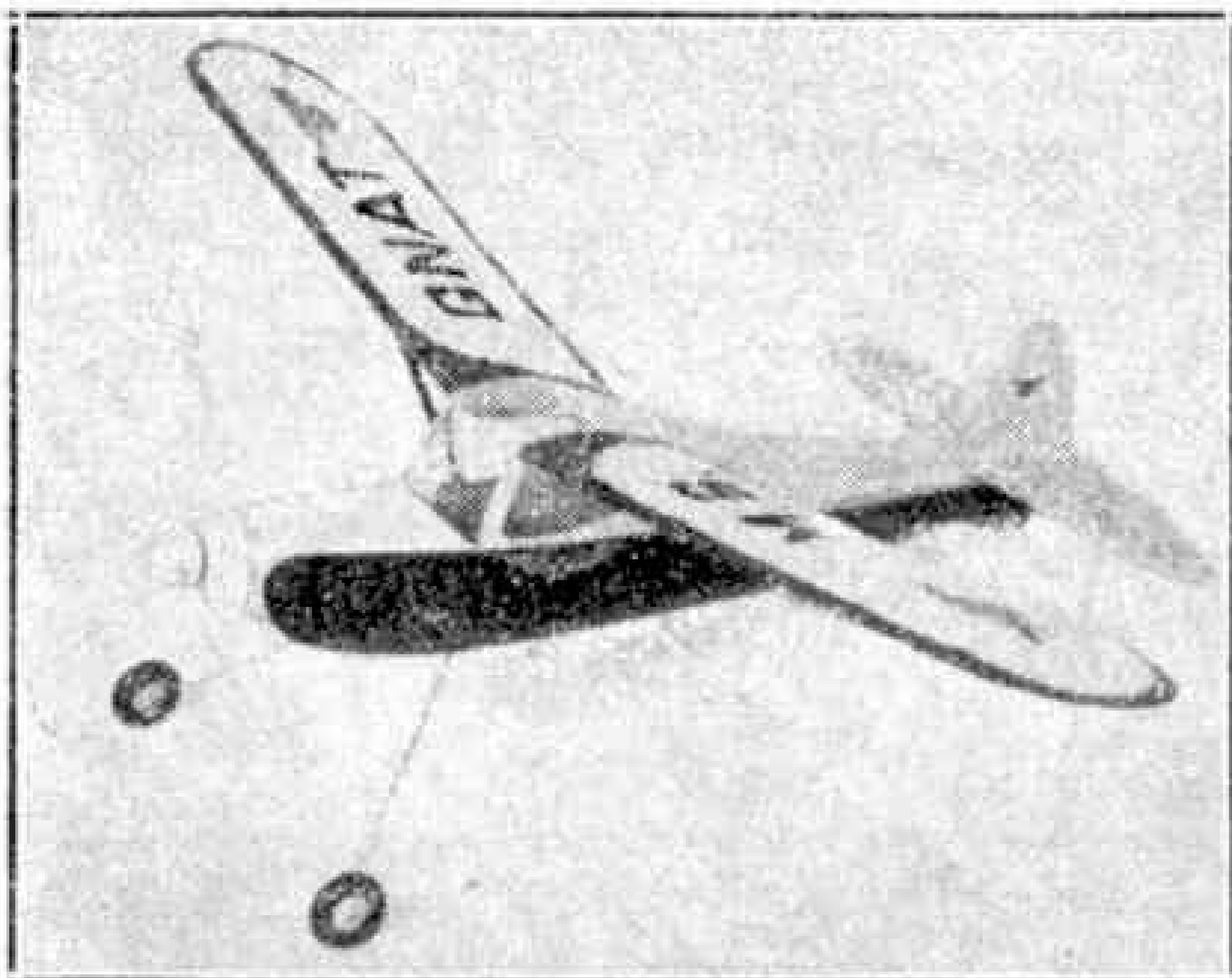

'M.S.' GNAT

A SEMI-SCALE RUBBER-POWERED MODEL
ASTOUNDING VALUE **6/9** Postage
 COMPLETE KIT OF PARTS **6d.**

Special Features of Kit

- Plastic prop.
- Many parts pre-cut to shape
- Moulded plastic wheels
- Packed in box with attractive three-colour label

Span - - 20 in.
 Length - 15½ in.
 Weight - 2 oz.

*A Model Expert and
 Beginner will be
 Proud to Own.
 TRADE SUPPLIED*

PRICE LIST: 2d.

THE MODEL SHOP

3a, RIDLEY PLACE, NORTHUMBERLAND ST.
 NEWCASTLE-ON-TYNE 1 Telephone: 22016

A CAREER AT SEA

His training over at
**THE PRINCE OF WALES
 SEA TRAINING
 SCHOOL**

he begins life in the
 Merchant Navy.



If your ambition is to be a sailor, an intensive training course of four months duration at one of the finest establishments of its kind in the United Kingdom will equip you with the knowledge and opportunity to fulfil that ambition.)

Enquiries from applicants between the age of 15 years 8 months and 17 should be addressed:

General Secretary:
BRITISH SAILORS' SOCIETY
 680, Commercial Rd., London E.14. (Tel. East 4191)

S.E.L. Motors make working models work!

Every product a real engineering job

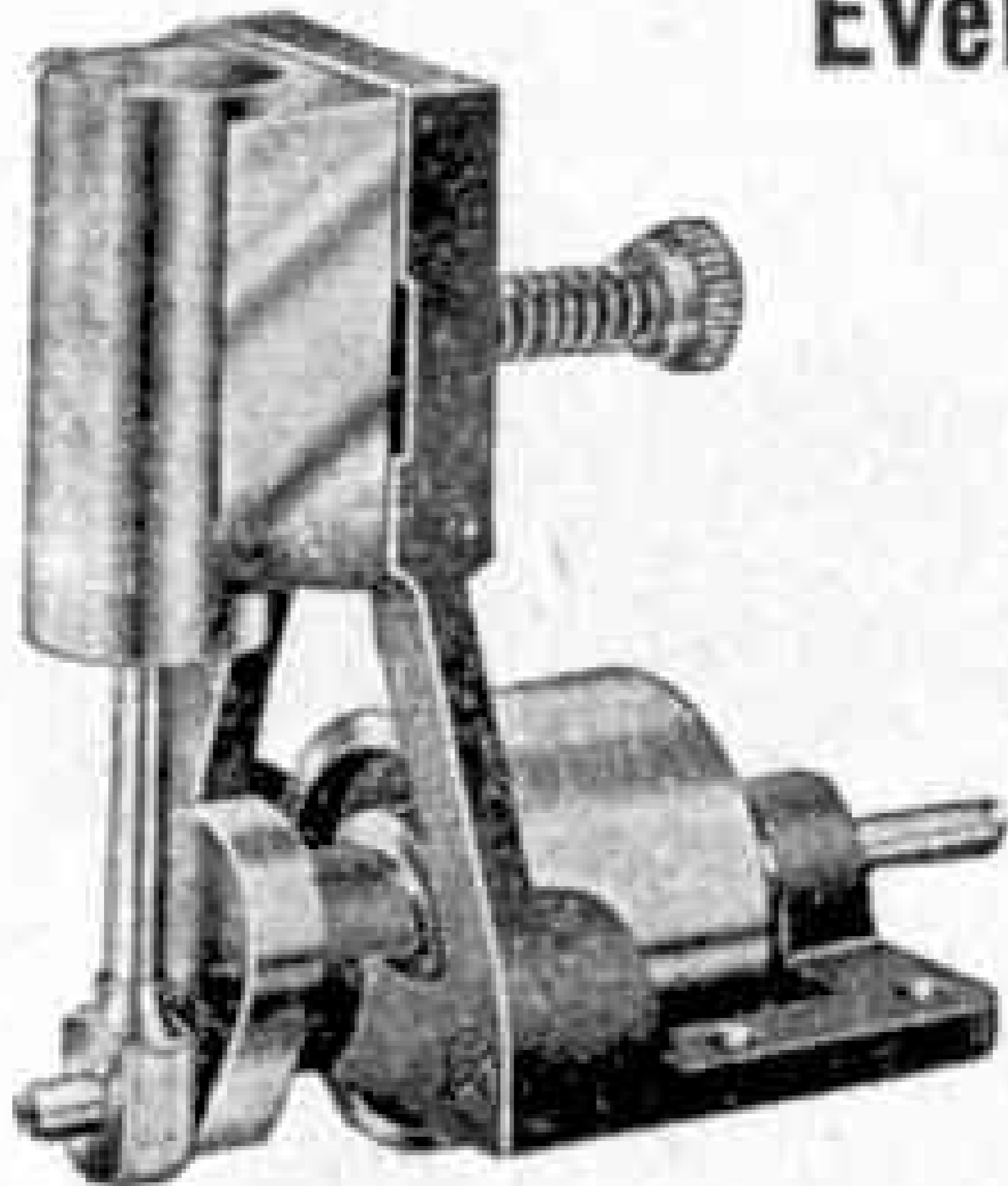

Model makers and owners of constructional kits like S.E.L. power units and accessories for the extra realism they give to all kinds of models.

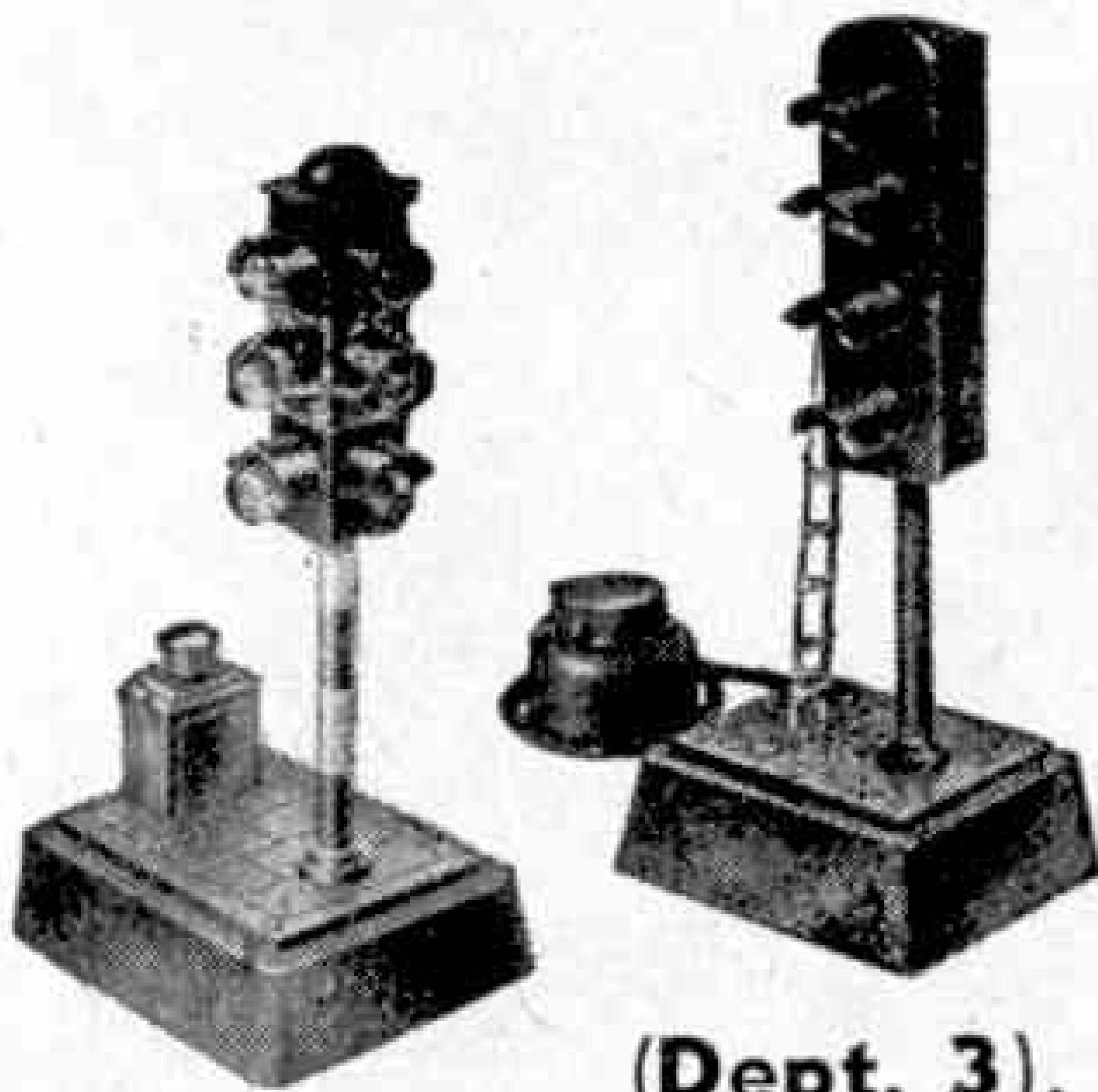
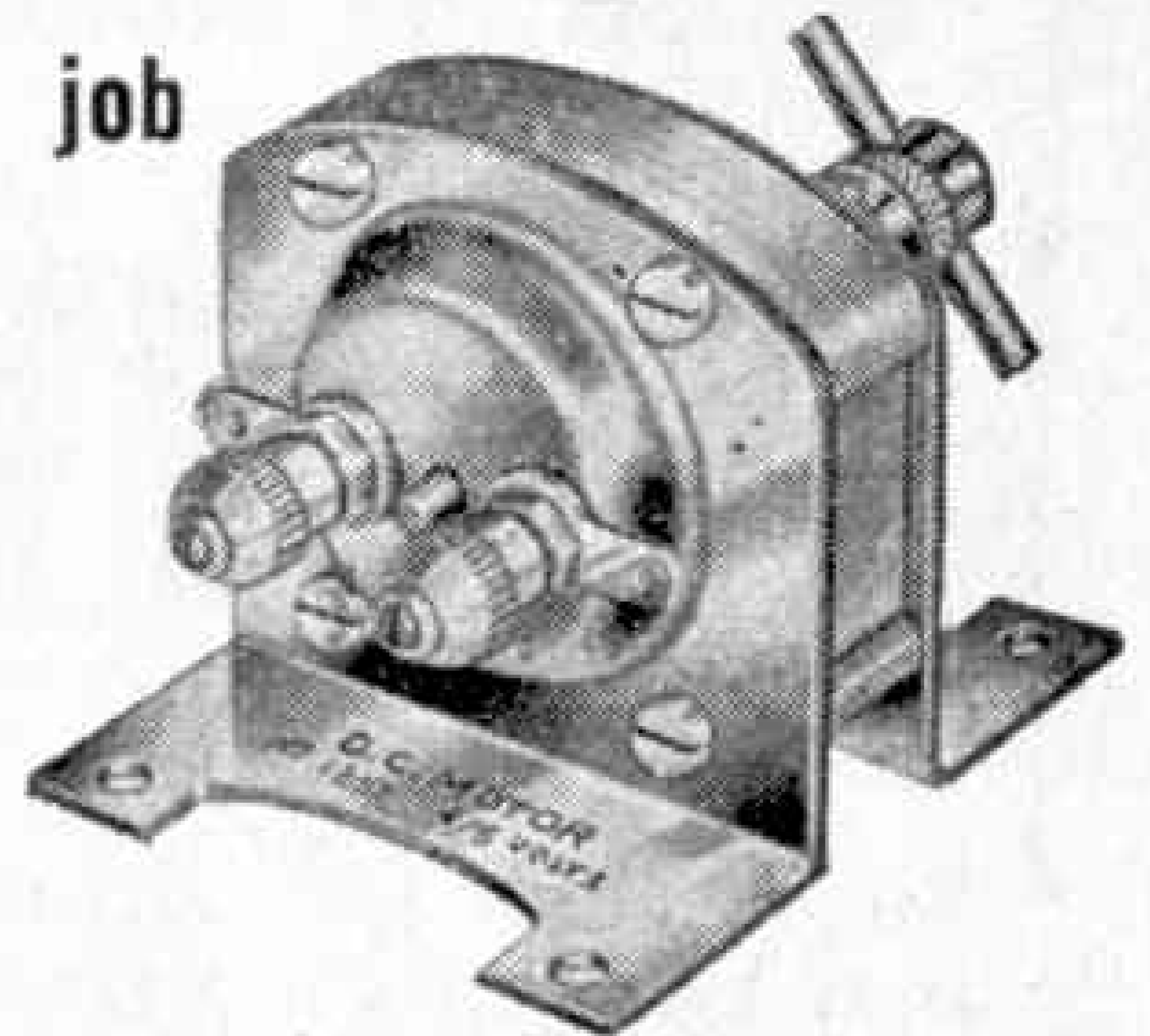

(Top left) S.E.L. STEAM LAUNCH UNIT. Light-weight precision-built power unit for model-boat builders. Very powerful. 15/6 inc. tax.

(On right) S.E.L. ELECTRIC MOTOR 1267. 4/6 volt d.c. motor specially designed for use in model boats and with constructional outfits. High power with low consumption. Adjustable brushes. 30/- inc. tax.

(On left) S.E.L. TRAFFIC LIGHTS 725 and ELECTRIC RAILWAY SIGNAL. With correct light sequence. The Railway Signal has a remote control switch. Powered by 4-volt flashlamp battery concealed in base. Traffic Lights, 27/6 inc. tax. Railway Signal, 32/6 inc. tax.

From all good dealers. Send postcard for illustrated List to

J. & L. RANDALL LTD

(Associated Company: SIGNALLING EQUIPMENT LTD)

(Dept. 3), MERIT HOUSE, POTTERS BAR, MIDDLESEX

THE Foden FLEET

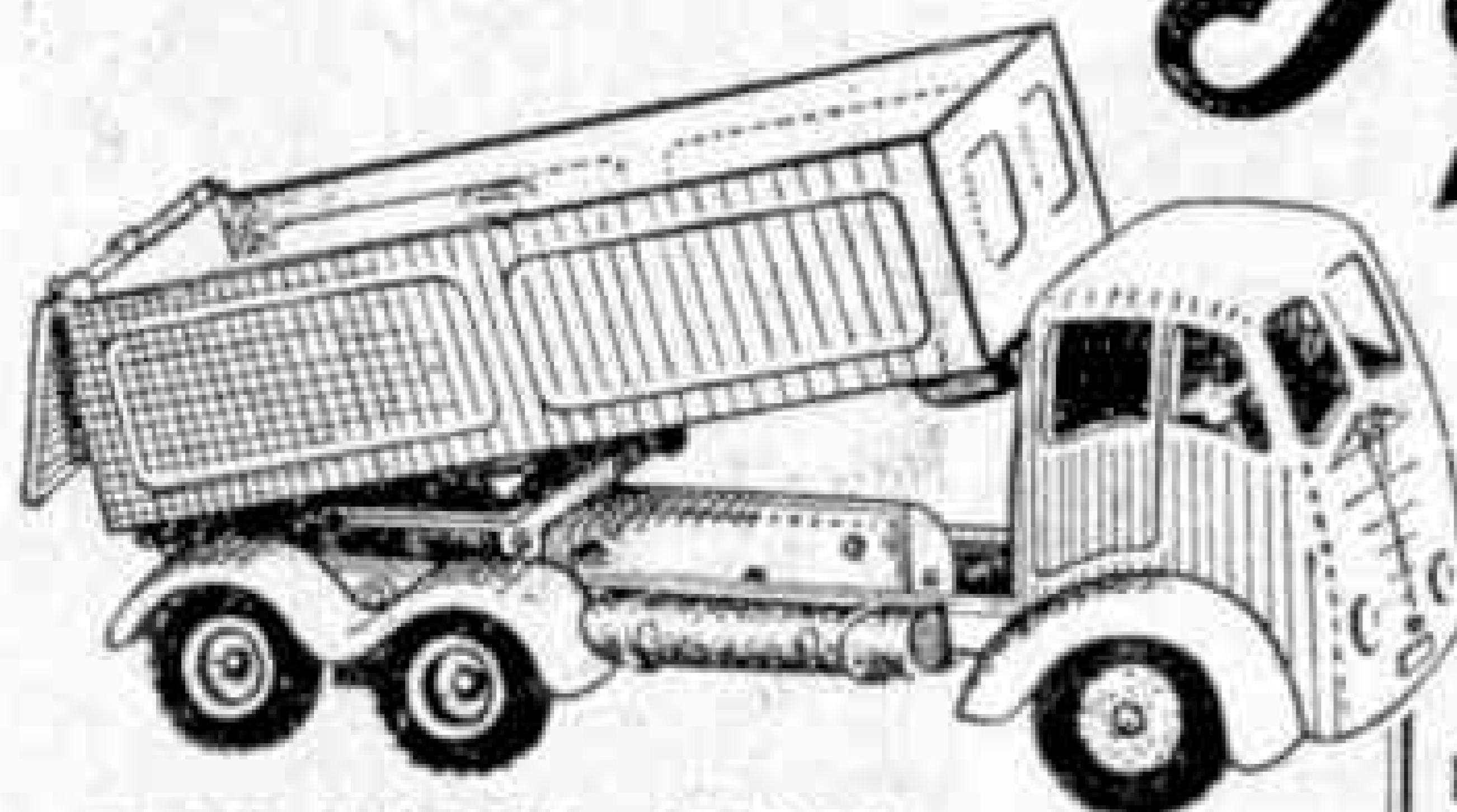

FODEN TIPPER LORRY 65/-

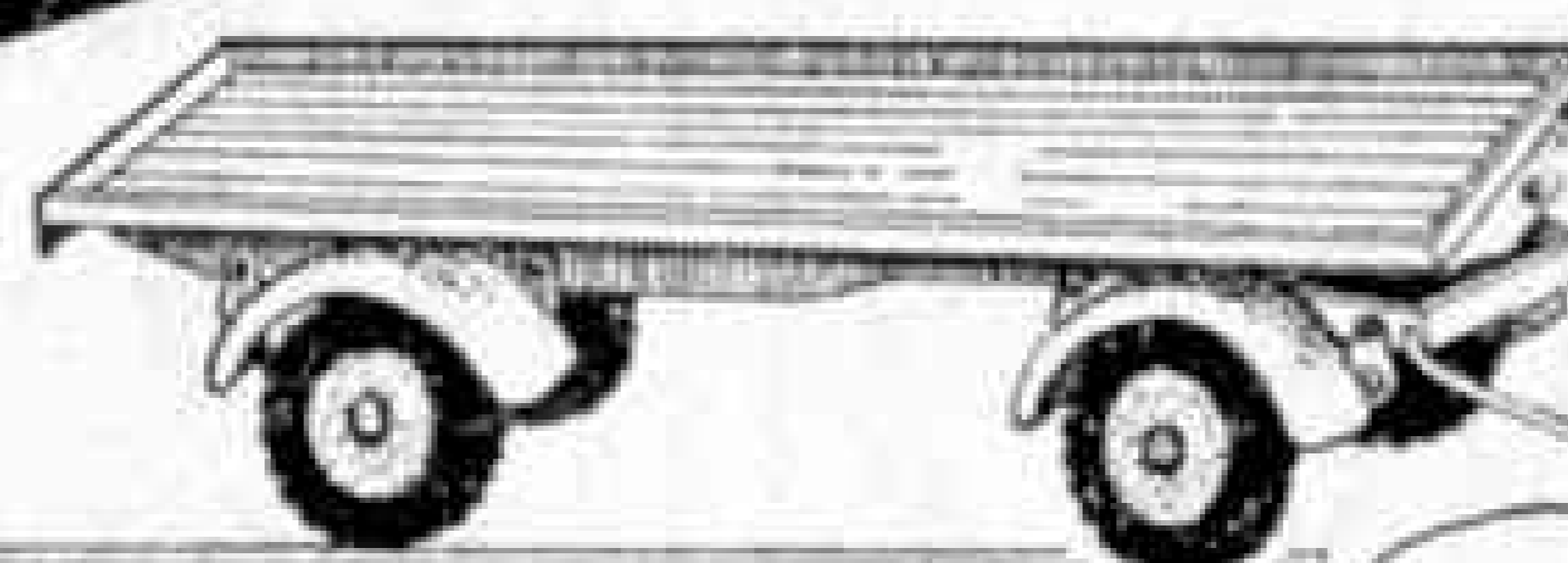

DYSON 8 TON TRAILER 18/6

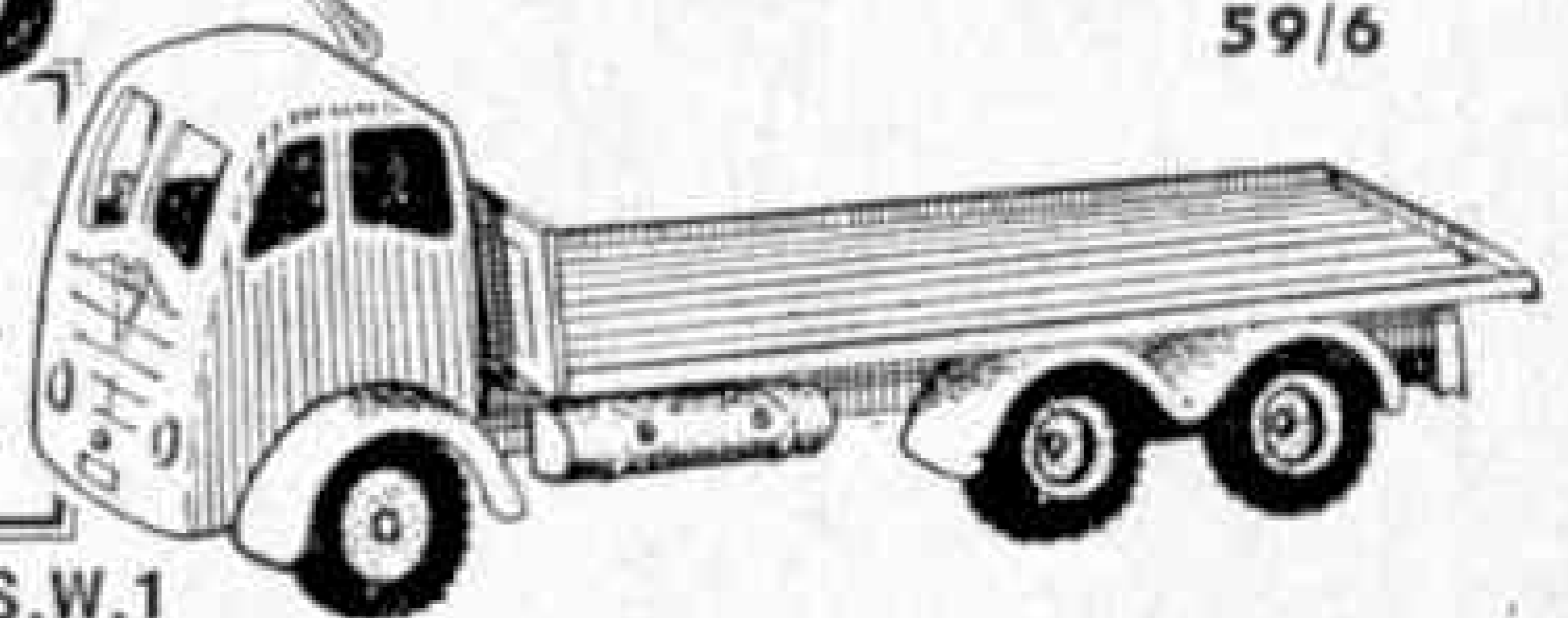

FODEN F.G. LORRY 59/6

Built from standardised parts, all replaceable. They come to you ready assembled, easily dismantled.

Ask your usual dealer.

If any difficulty write to: ABBEY-CORINTHIAN GAMES CO., London S.W.1

ONLY 1/9

THE NEW WONDER ELEMENT
For ALL GAS LIGHTERS

Get this new and improved gas lighter element to-day! It will outlast all others. Works on 1.5 v. or 2.5 v. battery. Current consumption is negligible and dry-cells last up to ten times as long with JET-VITA—the new wonder element. A six months written guarantee is given with each element. If your dealer cannot supply send P.O. 1/9d., giving his name and address to:—

JET-VITA

Sole Concessionaires:—
Vitality Bulbs Ltd., Neville Place, London N.22

SENSATIONAL OFFER OF A "SWISS" COMPANION KNIFE



with EIGHT attractions—Awl, Corkscrew, Safety Ring, Tin-Opener, 1½ in. Blade, 3 in. Blade, Bottle Opener, Screw-driver. Finest French make, razor-sharp, strong yet light and handy. Easily worth double.

Send 9/- for immed. delivery, C.O.D. 1/- extra. 3 for 25/-. 5 for 40/-. Money back guarantee. Trade enquiries invited.

8/6 POST etc. 6⁵

W. D. MORGAN & CO. LTD.
Dept. M.M.2, 2, Gray's Inn Road, London W.C.1

Tri-ang REGD TRADE MARKS MINIC

CLOCKWORK
Novelty
TOYS

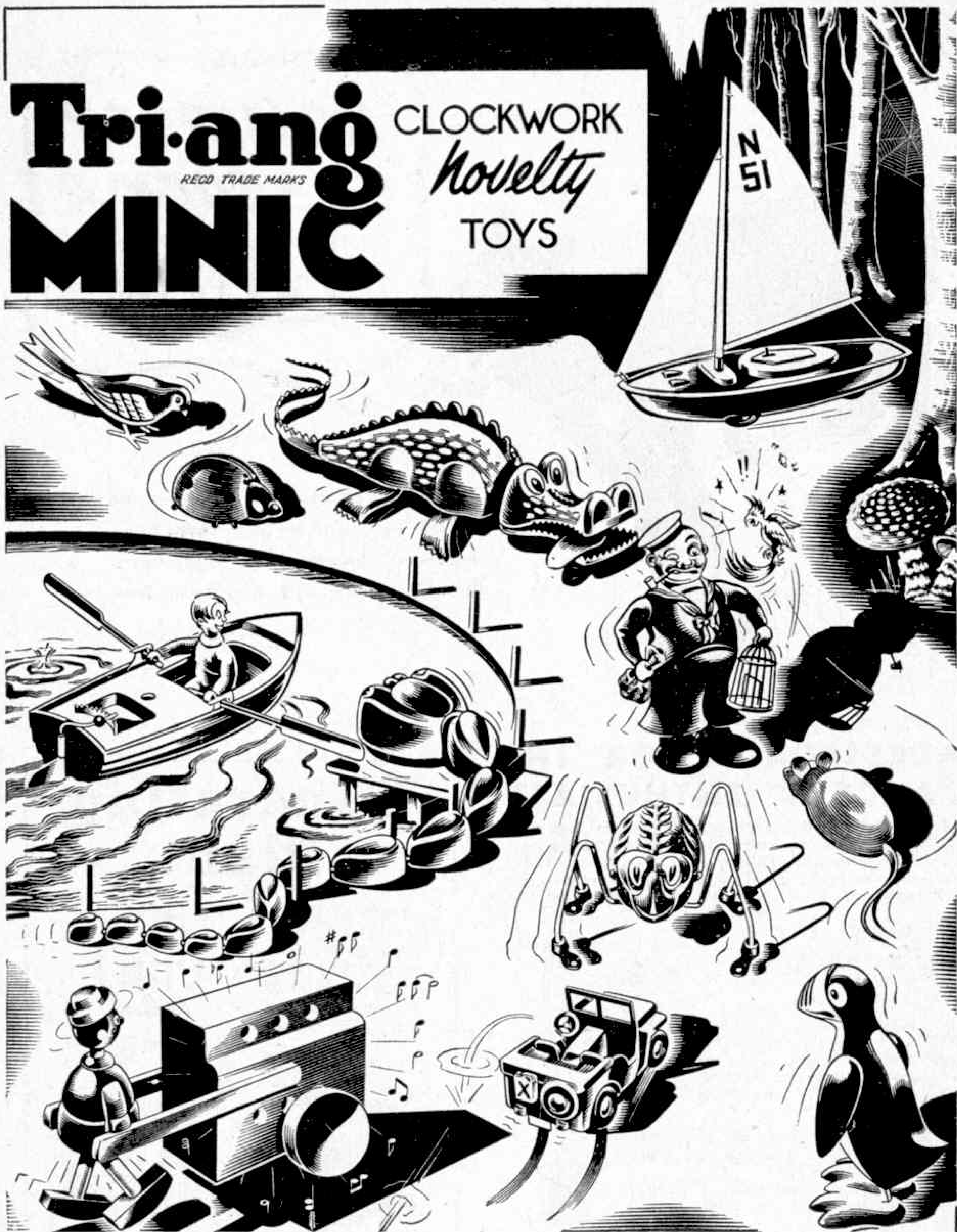

We do not supply direct—so visit your local Tri-ang Toy stockist and see the wonderful range of Tri-ang MINIC Clockwork scale models and novelties now available.

Lines Bros. Ltd.
Merton
London S.W.19
ENGLAND



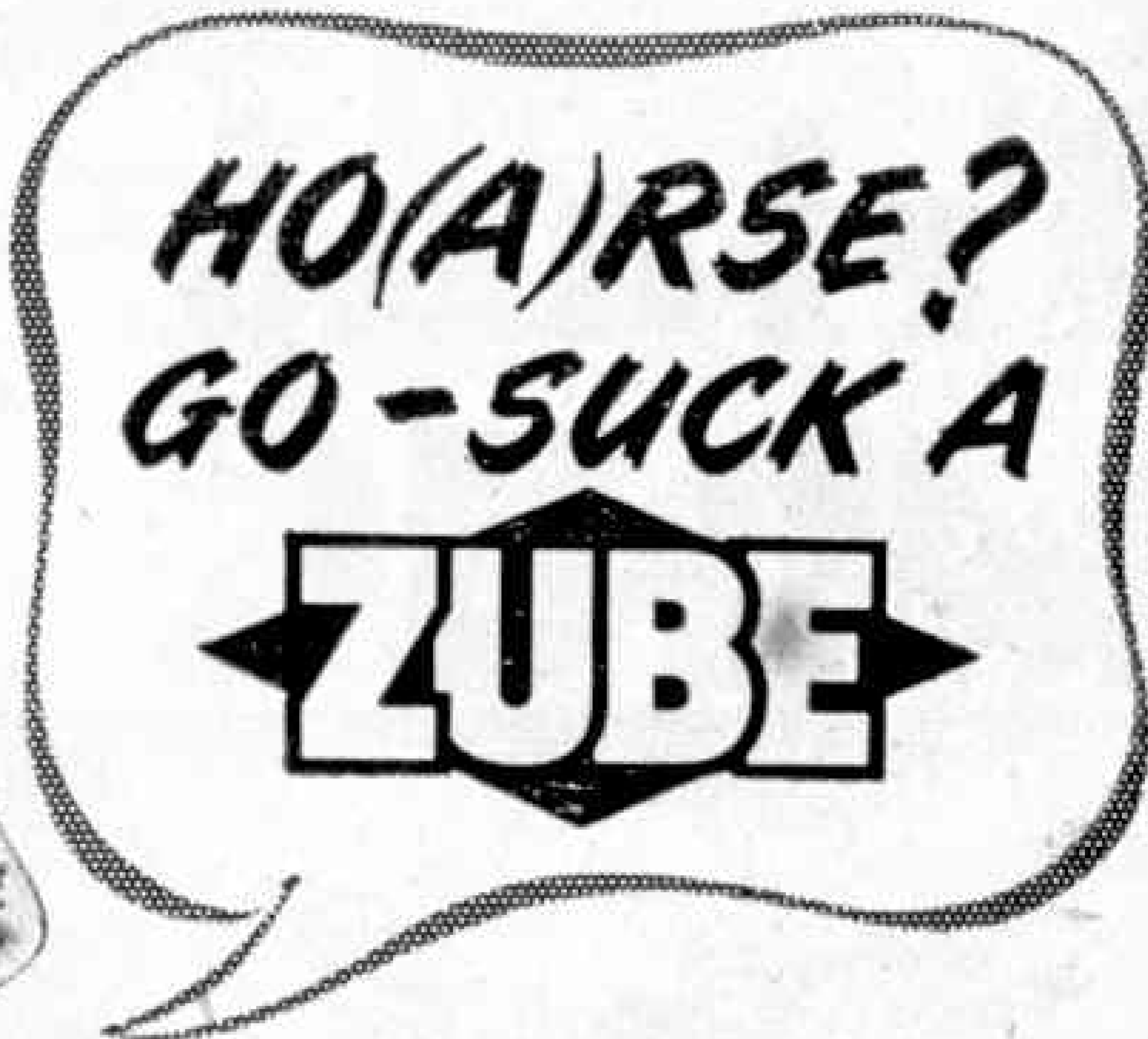

You'll love the taste of Zubes — and they'll keep you feeling warm however cold the weather! 5½d. an oz. loose; and in 8½d. and 1¼d. tins.

ACCESSORIES FOR THE GAUGE 'O' ENTHUSIAST

BASSETT-LOWKE accessories and fittings are immensely popular amongst Gauge 'O' Modellers. Their accuracy and realism greatly enhance Model Railway systems, creating the most true-to-life atmosphere. Also they are the best value for money.

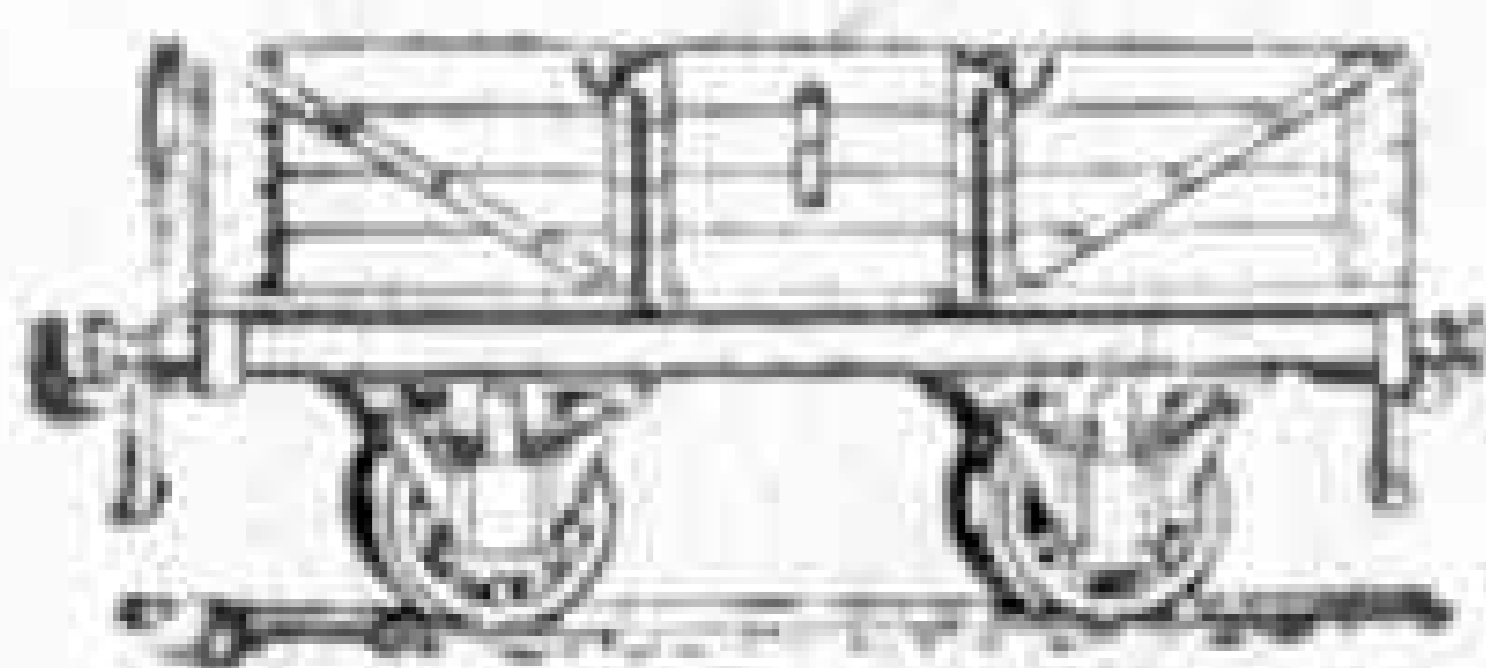

TINPLATE GOODS ROLLING STOCK, beautifully made—the best value for money. Open van as illustrated, 10/4; also available, Covered van, 11/11, and Brake van, 13/9.

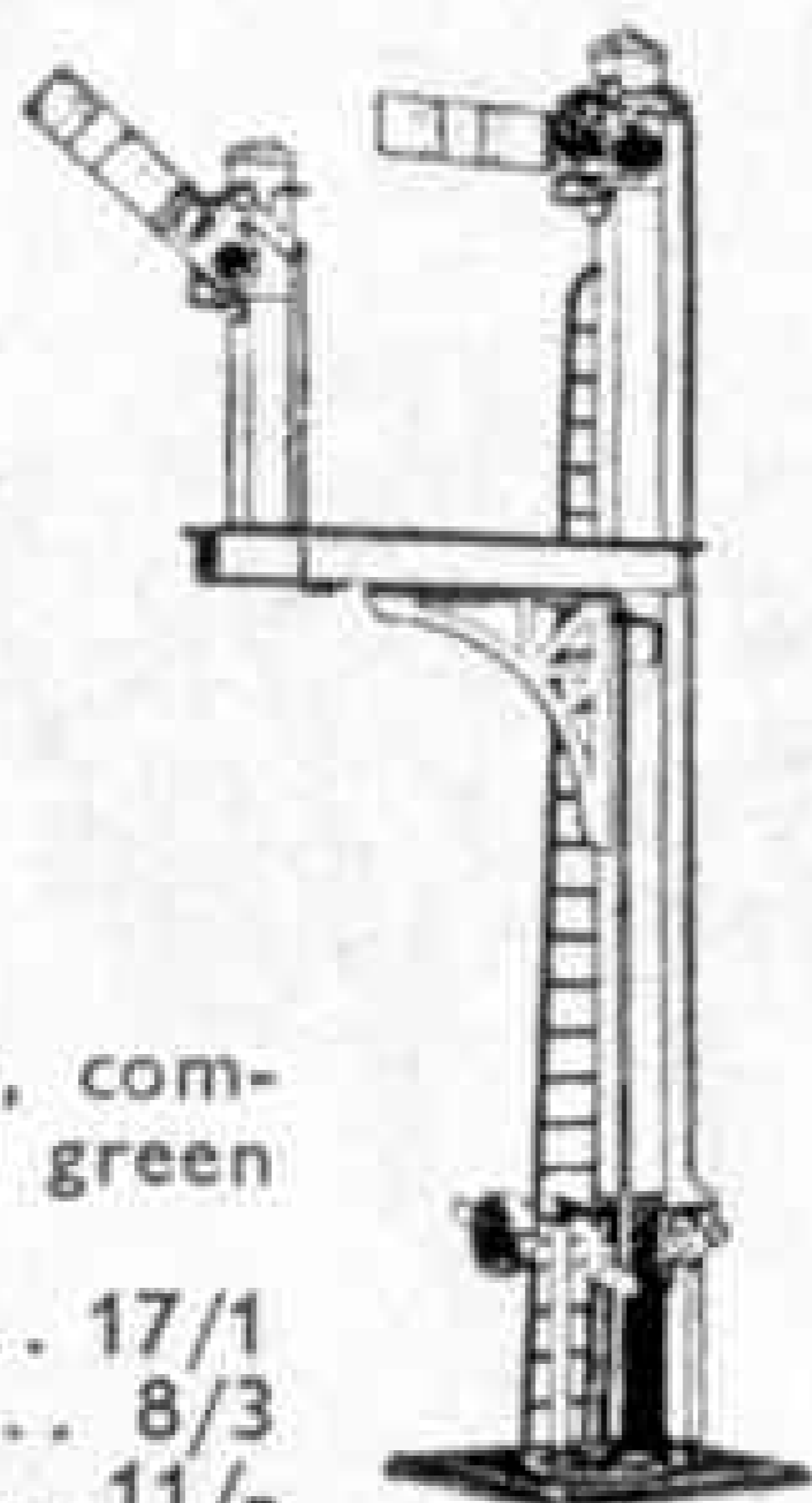

SIGNALS, single and double arm, complete with ladders and red and green spectacles. Price from:
 Bracket Signal as illustrated 17/1
 Also available Single arm signal .. 8/3
 Two arm signal 11/-

WRITE TO-DAY for the enlarged GAUGE 'O' CATALOGUE. Its 40 pages contain details of a host of accessories. Price only 1/-. Ref.: GO/17

BASSETT-LOWKE LTD.
NORTHAMPTON



LONDON: 112, High Holborn, W.C.1
 MANCHESTER: 28, Corporation Street

Generating Plant

Whatever the size or duty, BTH generating plant of exceptional reliability and proved performance can be supplied.



For electric plant or equipment of any description—specify BTH.

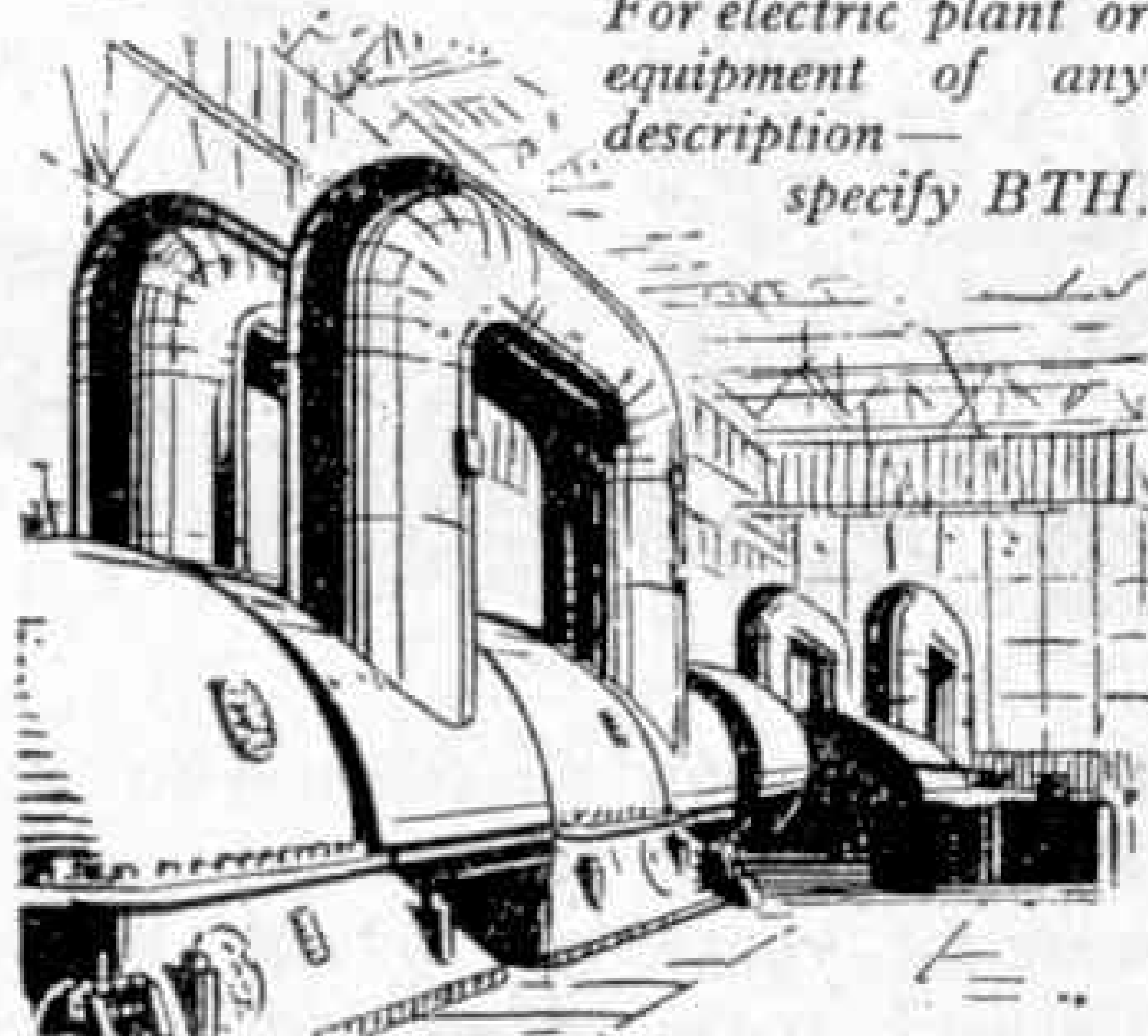

THE
BRITISH THOMSON-HOUSTON
 COMPANY LIMITED, RUGBY, ENGLAND, A1264

Keep your eye on Halfords

... and be sure of the finest selection of spares, accessories and equipment, including a full range of "Halford" "Raleigh" and "Robin Hood" Cycles —there's a Halford's branch in every large town.



**THE HALFORD
CYCLE COMPANY LIMITED**

HEAD OFFICE
239 CORPORATION STREET
BIRMINGHAM 4.

BRANCHES IN ENGLAND, SCOTLAND AND WALES

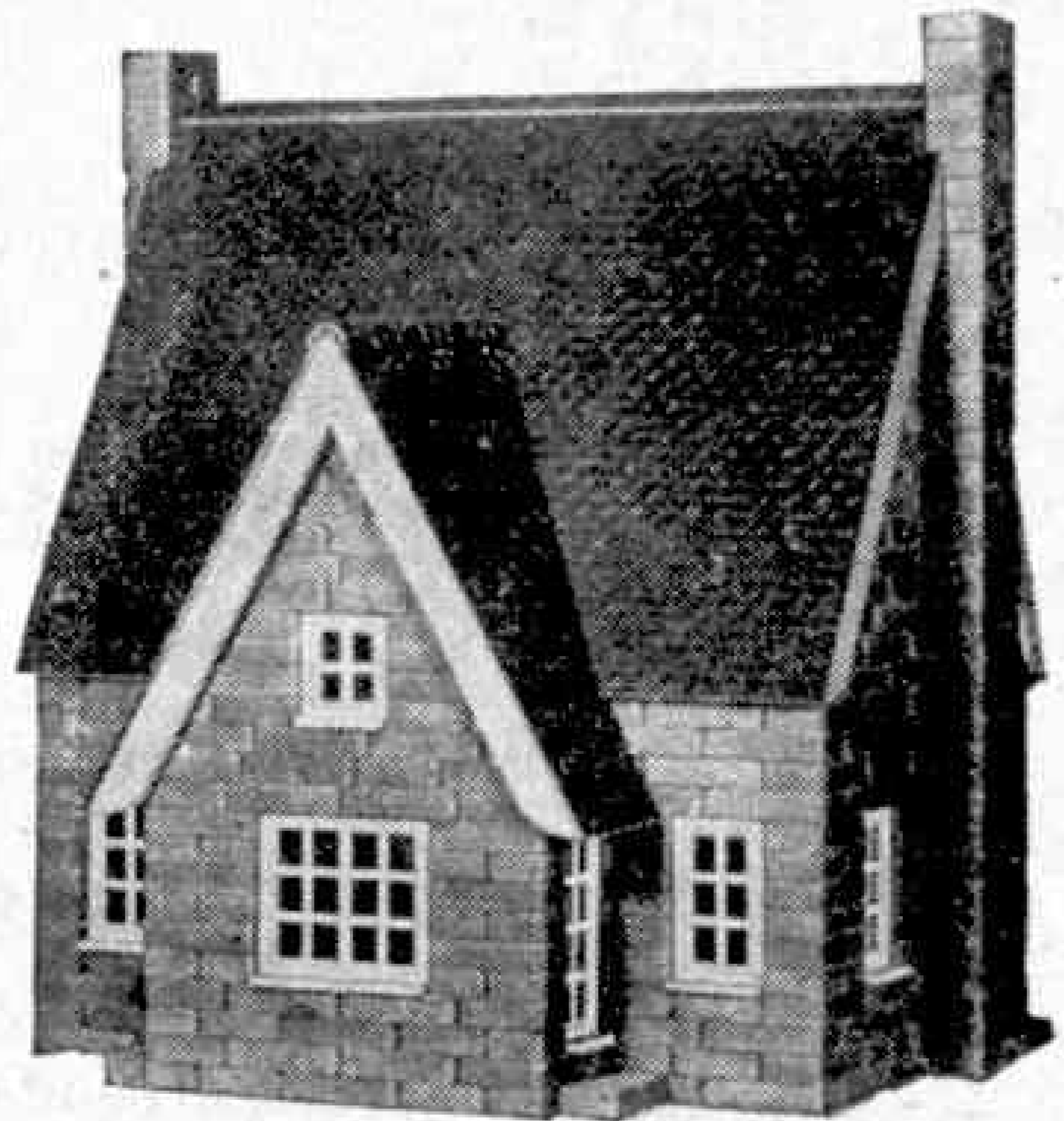

YOU can build this INN

WITH

BRICKPLAYER

BRICK & MORTAR
BUILDING KIT

It enables you to build Garages, Houses, Railway Stations, Signal Boxes, or from your own imagination. All railway models will fit 'O' gauge scale. Buildings can be permanent, or dismantled by merely soaking in water and the bricks used again and again.

BRICKPLAYER KITS AT 28/6 AND 52/6 ARE AVAILABLE FROM GOOD TOYSHOPS, HOBBY SHOPS AND DEPARTMENTAL STORES

ACCESSORY PACKS

No.	Contents	Price
100	100 Full-size Bricks	3/-
101	52 3/4-Bricks and 72 1/2-Bricks	3/-
102	Gable and Peak Bricks	3/-
111	Capping and Roof Tiling	2/6
112	Concrete Roofing	2/6
114	Bag of Brickplayer Cement	1/3
115	Roofing Cement	9d.
8107	2 Bay Windows with 31 Splay Bricks..	3/9

METAL WINDOW AND DOOR FRAMES

	F1	F2	F3	F4	F6	F8	F10
	8 1/2d.	6 1/2d.	7 1/2d.	5d.	4d.	6d.	7 1/2d.
8108	Sheets of Glazing, 1 1/2 in. x 6 in. (Plastic) 1 1/2d.						

If your dealer cannot supply, write for address of nearest stockist to:

J. W. SPEAR & SONS LTD.
DEPT. M • ENFIELD • MIDDLESEX

HOW TO CHOOSE YOUR **BSA**

Here's one important test

GET THE RIGHT SADDLE HEIGHT

SIT ON THE SADDLE with your leg straight, and the pedal down as far as it will go. You should be able to place your toe comfortably *underneath* the pedal. Adjust saddle height to give you this position.

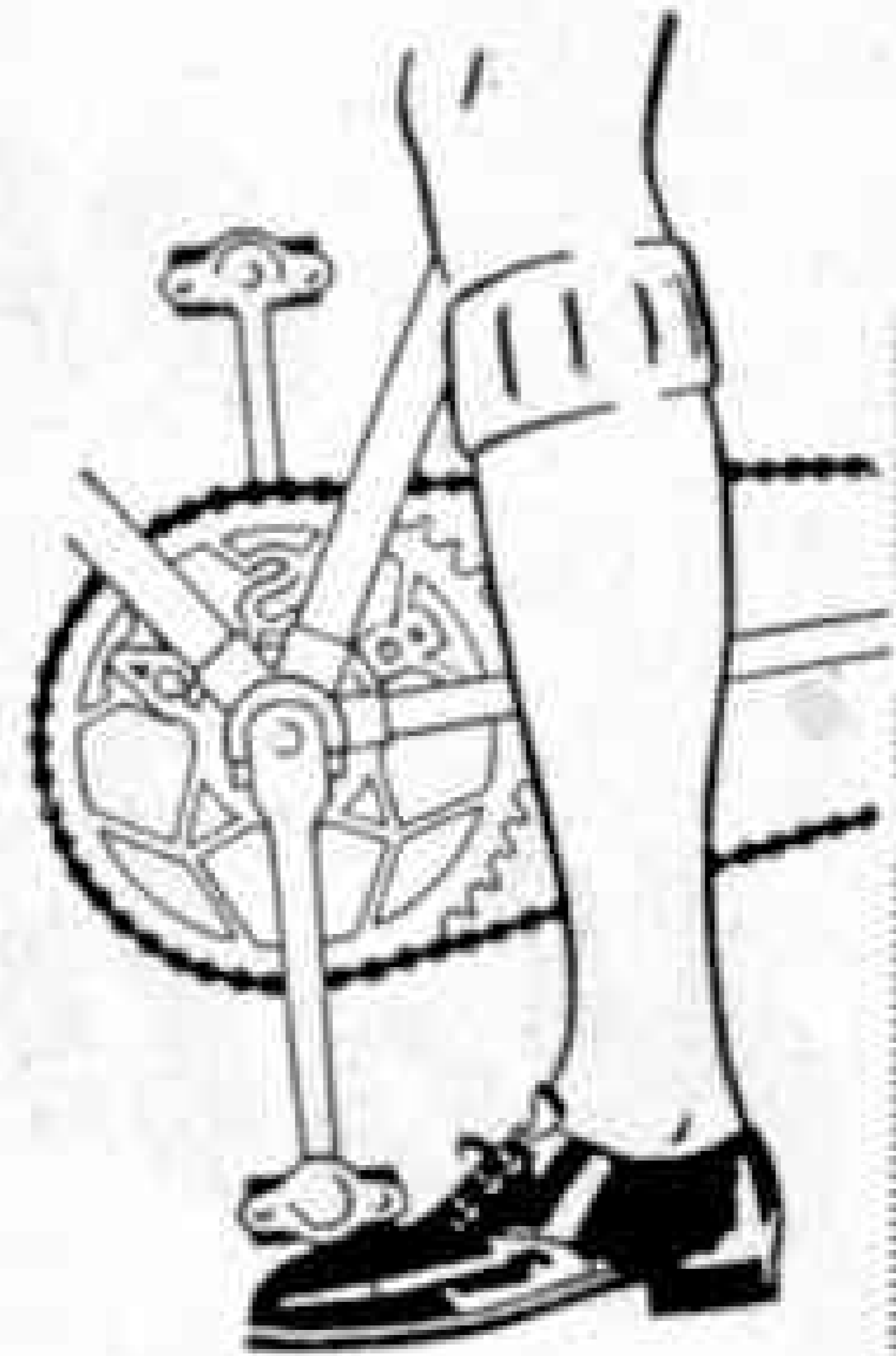

BSA

JUNIOR ROADSTER

SAFETY MODEL

Note the "SAFETY MODEL" transfer on the seat tube! Light but sturdily built 18 in. frame. Black and chromium finish. Wheels 24 in. Dunlop tyres. Chromium-plated, upturned handlebar. Roller lever brakes. Price £10.10.0 plus £2.9.0 Tax. (Colour finish extra—boy's Windsor Red, girl's Green.)



If you're really going to enjoy your cycling

**IT'S TIME
YOU HAD A **BSA****

*If you'd like a free catalogue, write to
B.S.A. CYCLES LTD., 31, Armoury Road, Birmingham, 11*

MECCANO

MAGAZINE

Editorial Office:
Binns Road
Liverpool 13
England

Vol. XXXVII
No. 2
February, 1952

With the Editor

Ancient and Modern Wonders

Mark Twain, the famous American humorist, wrote that everybody talked about the weather, but nobody did anything about it. In a somewhat similar strain it can be said that everyone talks about the Statue of Liberty when New York is mentioned; but very few know anything about it beyond its name and that it is there. "M.M." readers will now be able to claim better acquaintance with it, as an article describing its construction and erection appears in this issue.

In ancient times the Statue of Liberty would have qualified for inclusion among the Seven Wonders of the World, for it is three times the height of that other famous big statue, the Colossus of Rhodes, which was one of them. But we have far more wonders to-day than the ancients could have imagined. For instance, they had legends and dreams about men who could fly, but in their wildest moments they could never have foreseen the "Meteor" that made the tremendous cartwheel with which test pilot Jan Zurakowski astonished spectators at the S.B.A.C. Flying Display at Farnborough last October. I thought readers of the Magazine would like to know more about this startling new aerobatic and its inventor, so I have arranged for the inclusion in the March issue of a special article explaining how the daring pilot came to think of the manœuvre and how he makes it.

There are other good articles in store for readers, including the story of a giant dragline that stalks ponderously on two enormous metal feet instead of running on wheels or creeper tracks, and can stretch out to dig up iron ore nearly the length of a football field away. Another article will deal with a question that few

can answer—what holds up a New York skyscraper?

Some readers possibly can explain this, but they must have other puzzles in their minds, so here is an invitation. All who have any problems should just write to me about them. I do not claim that I know all the answers, but I shall always be delighted to help, and enquiries of this kind may suggest subjects for further articles that will interest other readers.

This Month's Contents

	Page
A Shining Canadian Arch ..	50
Schools for Adventure by W. H. Owens	52
Giant Road Trailer	55
Isle of Wight Railways by R. A. H. Weight	56
Europe's First Cat-Cracker ..	58
Parachutes by John W. R. Taylor	60
Making Stamps in America ..	66
by M. Lorant	
The "Saint Germain"	69
World's Tallest Statue by Arthur Nettleton	72
Hallade Track Recorder	76
by D. Stewart Currie, G.I.Mech.E.	

Air News, 70. Books to Read, 63. Club and Branch News, 84. Competitions Page, 93. Fireside Fun, 95. From Our Readers, 92. H.R.C. Pages, 85-7. Model-Building Made Easy, 80. Model Building Contest Results, 81. Among the Model-Builders, 78. New Meccano Model, 82. Of General Interest, 74. Photography, 75. Railway Notes, 64. Stamp Pages, 89, 91.

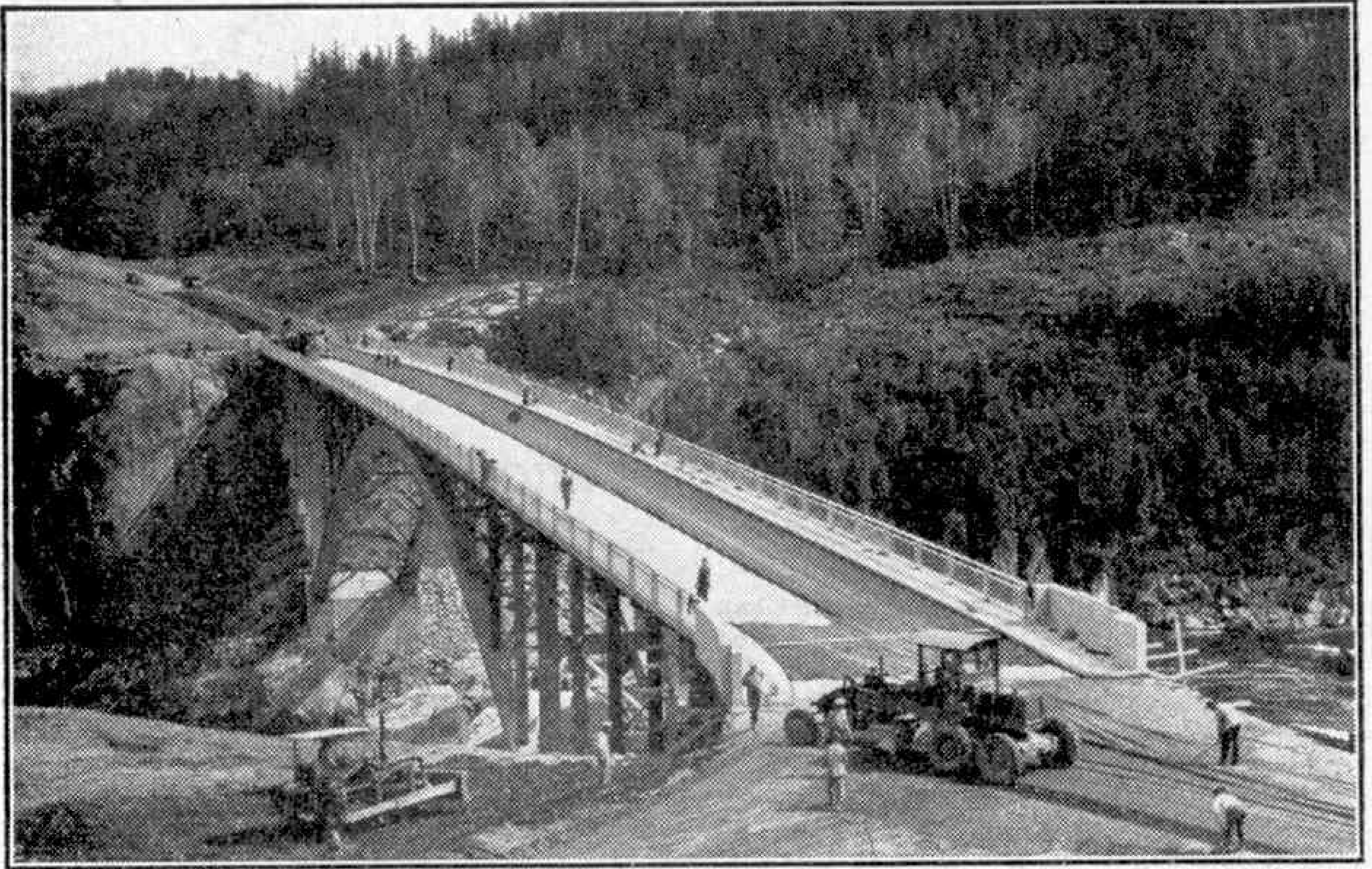

A Shining Canadian Arch

The World's First Aluminium Highway Bridge

ONE of the most remarkable hydro-electric power stations in the world is that at Shipshaw, in Quebec, Canada, which makes use of the waters of the Saguenay River. This stream pours down from the forested highlands to join the St. Lawrence about 150 miles below the city of Quebec. The two power stations that have been erected on its banks have a total maximum capacity of 1,500,000 h.p., and the larger one, known as Shipshaw No. 2, alone is capable of furnishing 1,200,000 h.p.

This giant installation was described and illustrated in the "M.M." for June 1949. Its chief purpose is to supply power for the production of aluminium in works established in Arvida, in the immediate neighbourhood of the Shipshaw No. 2 Power Station. The river intervenes between Arvida and the power station. To provide for its crossing there were two bridges, one for the railway and the other for a road, but these are a mile or so upstream, and it soon became necessary to build a new road bridge.

Paving the roadway and grading the approaches of Arvida Bridge, Quebec. The illustrations to this article are reproduced by courtesy of The Aluminum Company of Canada Ltd.

The surroundings of Arvida are of great natural beauty, and the shore of the river opposite the power station is intended to be developed as a landscape park area. Because of this careful thought was given to the appearance of the proposed bridge, and it was decided that one of the arch type was most suitable. There was a good engineering reason for the choice of this type, as the rock formations on the shores of the river are fully capable of taking the thrusts of an arch.

The new bridge was to be built in the heart of the aluminium district of Canada, and it was therefore decided to explore the possibilities of using this metal in its construction instead of steel. Experiments

with various aluminium alloys proved that this could be done, and to-day there is at this point a handsome bridge with a total length of 504 ft., the main span of which is a fixed arch with a length of 290 ft., all constructed of aluminium alloy, including the approach spans and every detail down to the handrails.

The Arvida Bridge is not the first aluminium bridge. A notable example on a smaller scale was completed in Sunderland just over three years ago. This is the Hendon Dock Bridge, a bascule bridge with an opening span of 121 ft. The Arvida Bridge is much larger, and it has the distinction of being the first aluminium highway bridge in the world. It is undoubtedly the forerunner of many aluminium structures of this and other types that will be built in the future.

Nature has made aluminium light and science has made it strong. From the wide range of its alloys the one that was chosen as the material for this pioneer bridge was that known as Alcan 26S-T, which was available in sheet or plate with a protective surface layer of aluminium with a purity of 99.85 per cent., or some other alloy covering material. Although the strength of this alloy exceeds that of mild steel, so that the parts of the bridge made with it could be of approximately the same shape and size as similar members in structural steel, it differs remarkably in weight. This difference indeed is so great that members of the bridge constructed of the alloy have only about a third of the

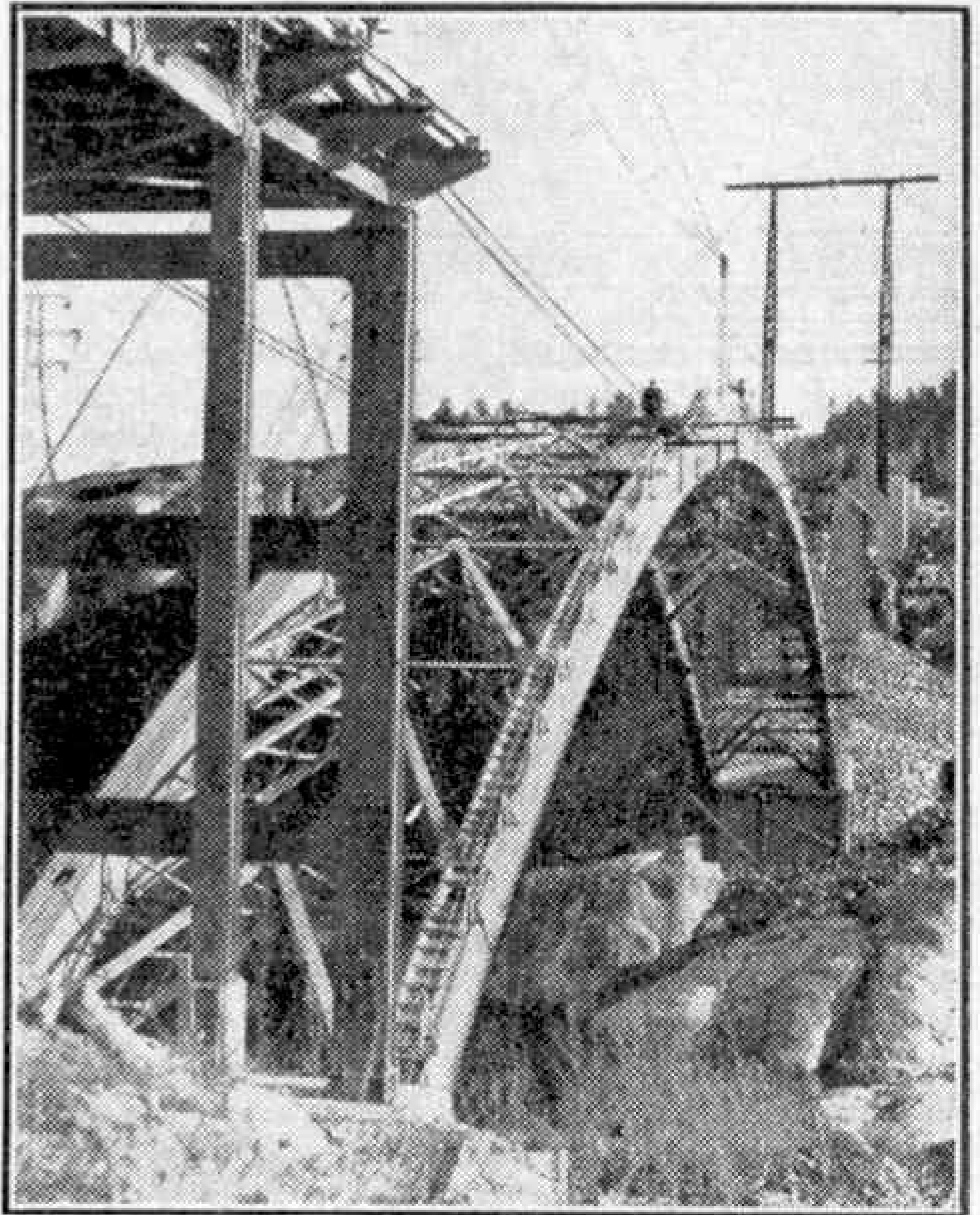

The world's first aluminium highway bridge under construction at Arvida. The arch has been completed and is ready for the erection of the posts that support the deck structure.

weight they would have had if made of steel. Most of the pieces of the bridge were lifted by hand in preparation. Steel pieces of the same dimensions would have required hoisting power.

The alloy can readily be sawn on a bandsaw machine. Punching and drilling can be carried out with complete success, and the necessary machining also offers no difficulty. Plates of the alloy can easily be bent as required, mostly in the cold, and this too was an advantage, although the use of bent plates was avoided as much as possible.

Rivets of another aluminium alloy were used in fabrication. These were of a new design and were driven cold. In assembly the greatest care was taken to avoid damage to the edges of the holes through which drift pins and bolts were to be passed; and to keep out moisture, and so to prevent galvanic action that would lead to corrosion, all surfaces that were to be brought into contact were first given a coating of a special mastic, to which a small percentage of zinc chromate was added. Aluminium alloys have excellent weather resisting qualities, and when completed the bridge was cleaned, but not painted.

The heaviest rib (Continued on page 94)

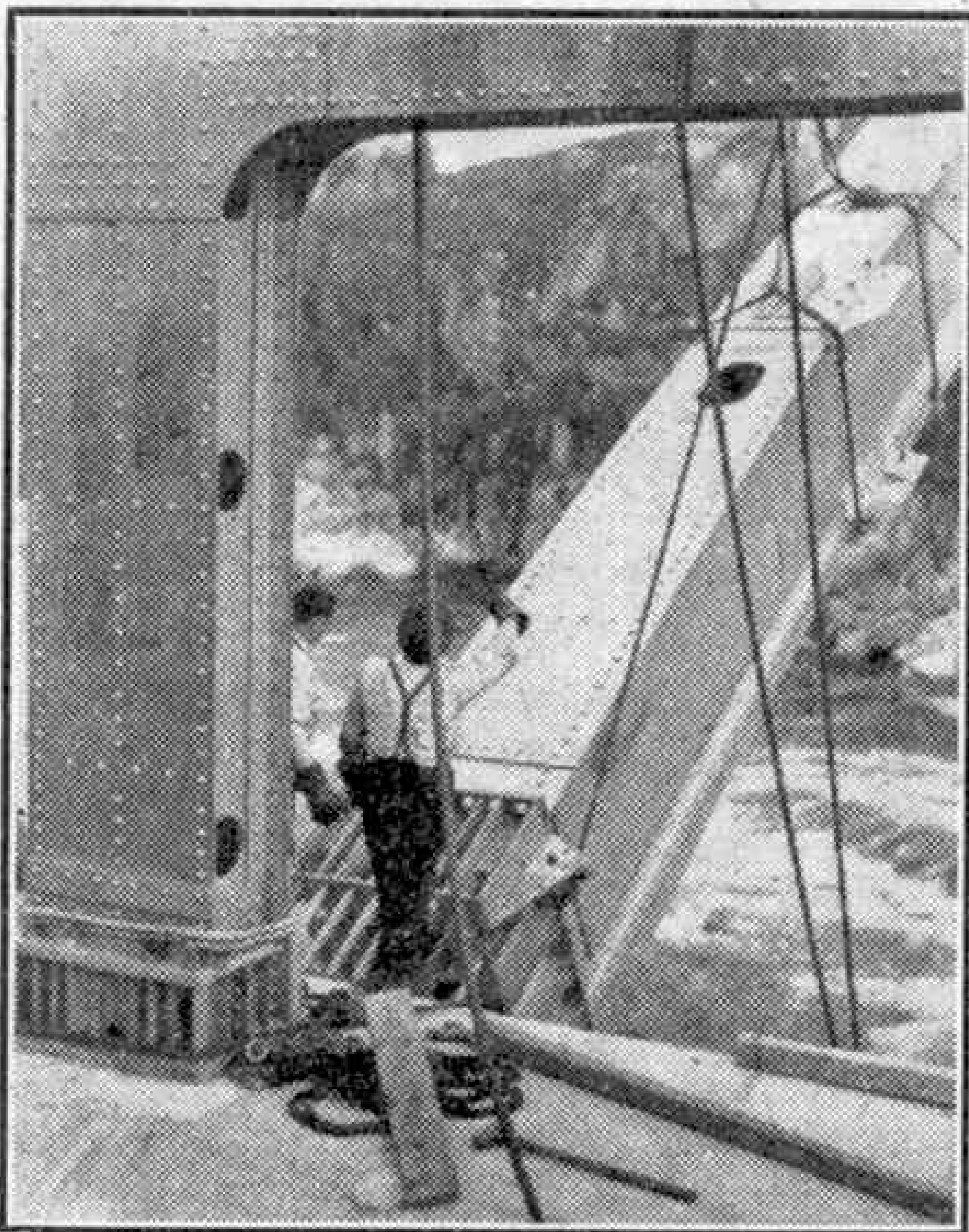

Placing one of the haunch sections of the arch in position, to be secured to its abutment by 14 anchor bolts, each 2 in. in diameter.

Schools for Adventure

By W. H. Owens

DURING the past 10 years thousands of teen-age boys in Britain have experienced something quite new and exciting in the way of education. At a sea school on the Welsh coast, and more recently, at a mountain school in the English Lake District, boys with every kind of social background have attended short character-training courses, the keynote of which is—Adventure!

The Outward Bound Sea School was founded at Aberdovey, Merionethshire, in 1941 by two pioneers in this work, Lawrence Holt and Kurt Kahn. The site is really an ideal one, set on a magnificent river estuary between the sea and the mountains. River, sea and mountain slopes all play a most valuable part in the training courses.

From the windows of the school house one has a wide, uninterrupted view of Cardigan Bay and the coastline beyond the mouth of the Dovey. Rising up behind it are the hills of Aberdovey, from whose summits can be seen the 2,927-ft. peak of Cader Idris.

Just after the war this sea school was taken over by the Outward Bound Trust, which was formed to carry on and develop the idea of the founders. It soon became evident that not nearly all the boys wishing to take the courses could be accommodated in the one place. So in 1950 a second centre, the Outward Bound Mountain School, was established at Eskdale, Cumberland. Others are being planned for the future, as the Trust's funds permit, until there are sufficient schools in different parts of the country to meet the demand.

Both schools are run on the same lines and with the same basic purpose, which is to develop the character of every boy who attends a course and promote a sense of manliness and responsibility in him. Through self-discipline, teamwork and adventure, and some physical hardship

and personal risk, a boy is given just those conditions in which he may, perhaps for the first time, discover his true self. He realises that his stay with Outward Bound is not just a holiday. Training is serious, there is a definite job to be done every day, and there are comrades he must not let down by relaxing his own efforts.

Courses last for periods of four weeks and are open to all boys between the ages of 15½ and 19½. Those of all classes and nationalities meet together in a spirit of good fellowship at the Outward Bound Schools, and for this reason alone they are of the greatest value. Many boys come from factories, farms and offices; some come from the public schools and

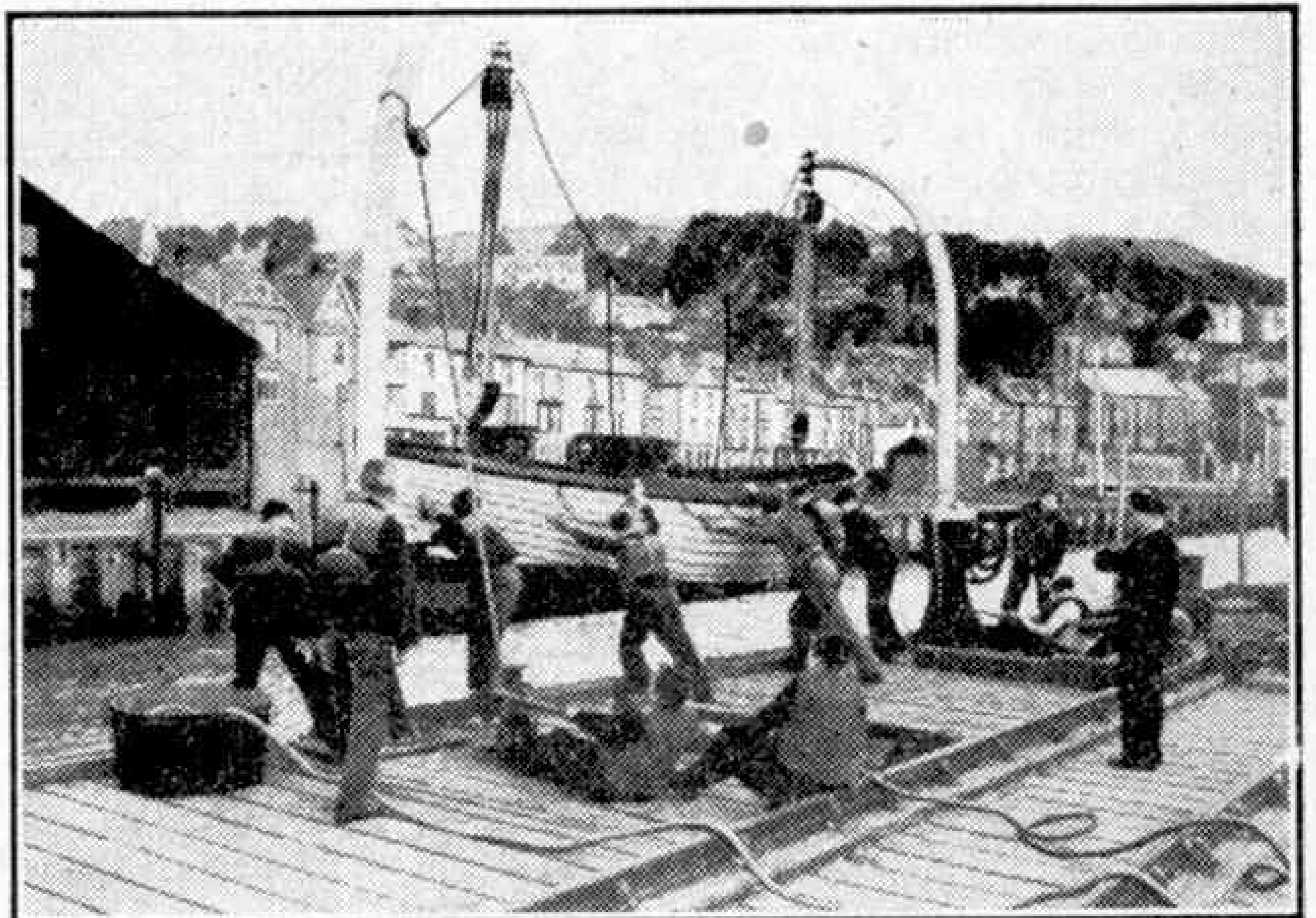

"Outward Bound" boys launch the ship's boat.

universities; and many have never been away from home before, though the majority have been earning a living for a year or two.

When a fresh group of boys arrives at Aberdovey, they are divided into teams, which are known here by the nautical term of "watches," and they remain attached to these groups for all their activities throughout the course. Soon after arrival, the Chief Officer appoints a leader and vice-leader from among the boys themselves. But this appointment may be just a temporary one, for after a few days the teams may decide



On trek across the mountains of Wales, including Cader Idris, 2,927 ft. high. Boys of the "Outward Bound" Sea School complete their course with a 35-mile expedition, undertaken in all kinds of weather.

But the greatest sea adventure of the course is a three-day cruise in Cardigan Bay in the "*Warspite*." This vessel is a naval auxiliary ketch of 80 tons, chartered to the Outward Bound Trust by the Marine Society. Each watch in turn forms a crew, and under a Master Mariner the boys get plenty of first-rate experience of the open sea and a real chance to practise what they have learnt about the art of sailing, navigation and general seamanship. The bay can often be very rough

differently, and are entitled to do so.

Each day begins with a short run, physical training and a cold shower, winter and summer alike. That shower may at first be a shock to those who are not used to it at home, but very few boys mind it by the third morning. At breakfast, as at all the other meals, staff and boys sit together, all taking part in conversation on a basis of complete equality. In this and other ways the principle of community life is quickly established.

Roughly half the training at Aberdovey is concerned with the various branches of seamanship. The other half is devoted to land subjects, ranging from athletics to mountain climbing.

Although the sea school is not intended for boys who wish to take up seafaring as a career—some of them do afterwards, nevertheless—the sea and the navigation of craft upon it are excellent means of developing just those qualities of manhood that are sought in the Outward Bound aims. Against the sea, as against the mountains, a boy can measure his own strength and fitness, and steadily gain confidence in his physical and spiritual powers. Courage, initiative and resource are just as important as physical strength in meeting the challenge of Nature, whether on land or at sea.

Routine instruction is given by experts in general ropecraft, knotting and splicing, and there is daily rowing and sailing practice in the estuary. Then, after a few days, each watch is able to take out sailing cutters alone with the officer in charge watching their progress from the shore.

and windy, and the trip is certainly no pleasure cruise for those not used to a choppy sea.

Daily athletics in the school grounds are a most essential part of the course, contributing to the physical build-up of each boy and preparing him for the more severe trials ahead. What matters most

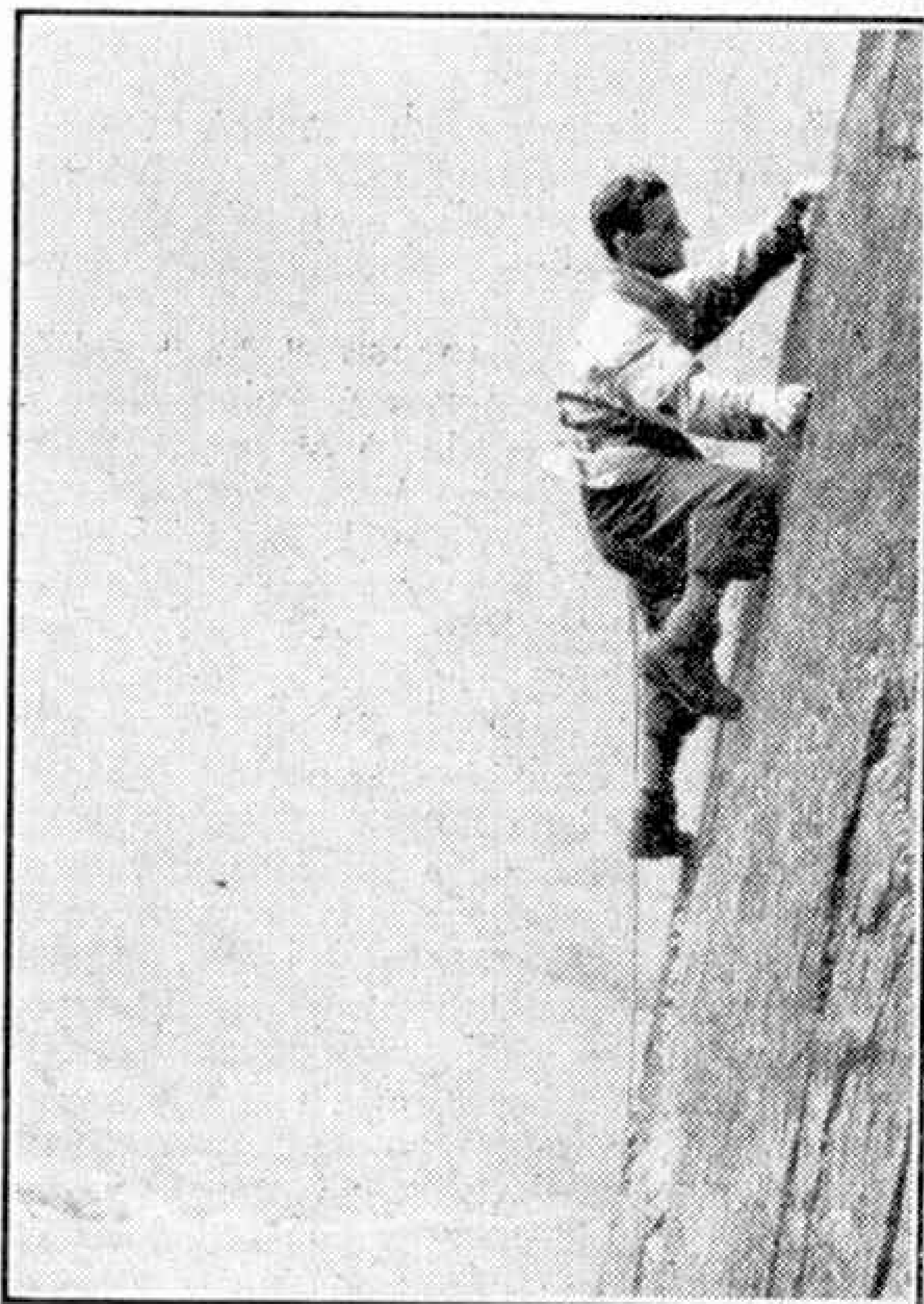

Mountain School training includes the fundamentals of rock climbing. Here the instructor is seen taking the lead in the climb.

in any sport, whether it be jumping or javelin throwing, is not that the individual should compete for honours against his fellows, but that he should strive hard to improve his own performance as much as he can during his four weeks' stay.

Much time is devoted also to cross-country hiking and running, mountaineering and map and compass work. The regular Sunday expeditions over the Merionethshire hills are a great feature of the training. Each expedition is longer and harder than the previous one, in preparation for the supreme effort of endurance—a 30-35 mile trek over difficult country that has to be accomplished in one day.

This final expedition is made in almost any sort of weather and the conditions make the going tough indeed in places. The route includes mountains up to about 3,000 ft. in height, with really hard climbing over jagged rocks on the higher slopes of the Cader Idris range.

At Eskdale the emphasis of the training is put on mountain climbing. The mountain school lies among the western foothills of the Lake District, with such famous peaks as Scafell and Great Gable only a few miles distant. The Warden and his staff of instructors are all keen mountaineers, and after boys have been at the school only a couple of weeks they have become reasonably skilled in the sport, even though many of them have never tackled a mountain before.

Right from the time it was opened the school has maintained an official mountain rescue team composed of boys and instructors alike. This has already been in action on a number of occasions.

Mountaineering in the widest sense of the word is introduced to the boys at Eskdale. It includes a good deal more than the actual climbing, with such a variety of subjects as map and compass reading, fell walking, the use of mountain equipment, meteorology and natural history.

Expeditions to the fells may be undertaken at the shortest notice, and all kinds of difficult or unexpected exercises are devised in order to test individual endurance and courage. Sometimes there are midnight rock assaults, or perhaps an early morning parade on a mountain summit in the neighbourhood.

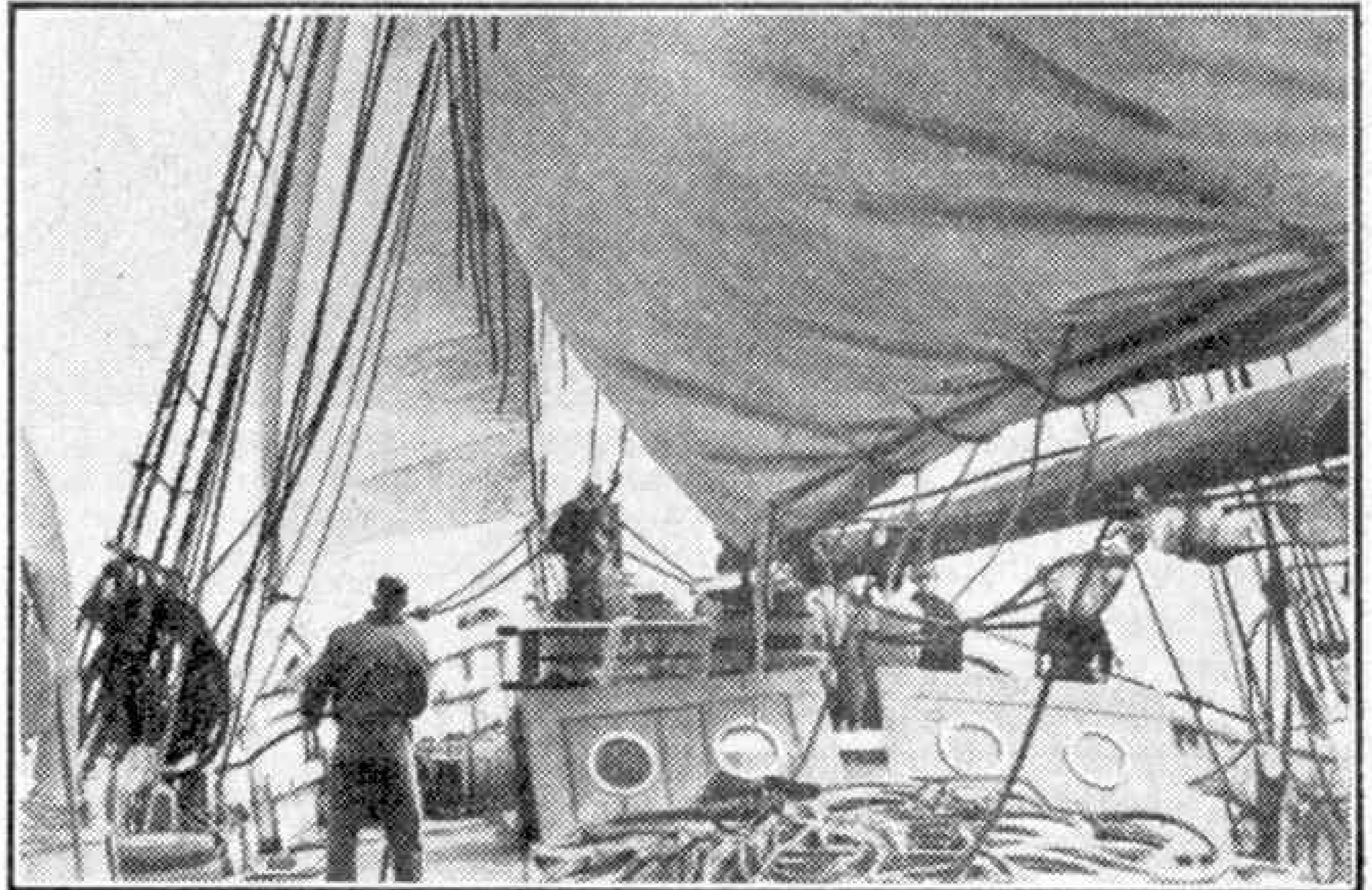

Aboard the 90-ton ketch "Warspite" during a three-day cruise in the Irish Sea. Boys of the school act as crew.

Rescue work is one of the most important features of the course, and full-scale rehearsals with equipment are undertaken regularly, so that there is always a team ready to answer a real emergency call at any time.

Opportunities for boating practice are provided by the lake within the school grounds and the estuary of the river Esk not far away, and boys have the use of both kayaks and Canadian canoes. In connection with this boat work there is instruction in swimming and life-saving, the construction of rafts, bridges, and so on.

More than 8,000 boys have now passed through courses at the two Outward Bound Schools. Many of them came ill-prepared physically for training of such a tough character, yet an insignificant number have failed to complete the course. All who have succeeded have returned to their jobs and homes completely fit, invigorated, and with a new and more purposeful outlook on life.

Not the least important results of Outward Bound training are the firm friendships that are made between boys of quite different social groups, and quite often different races.

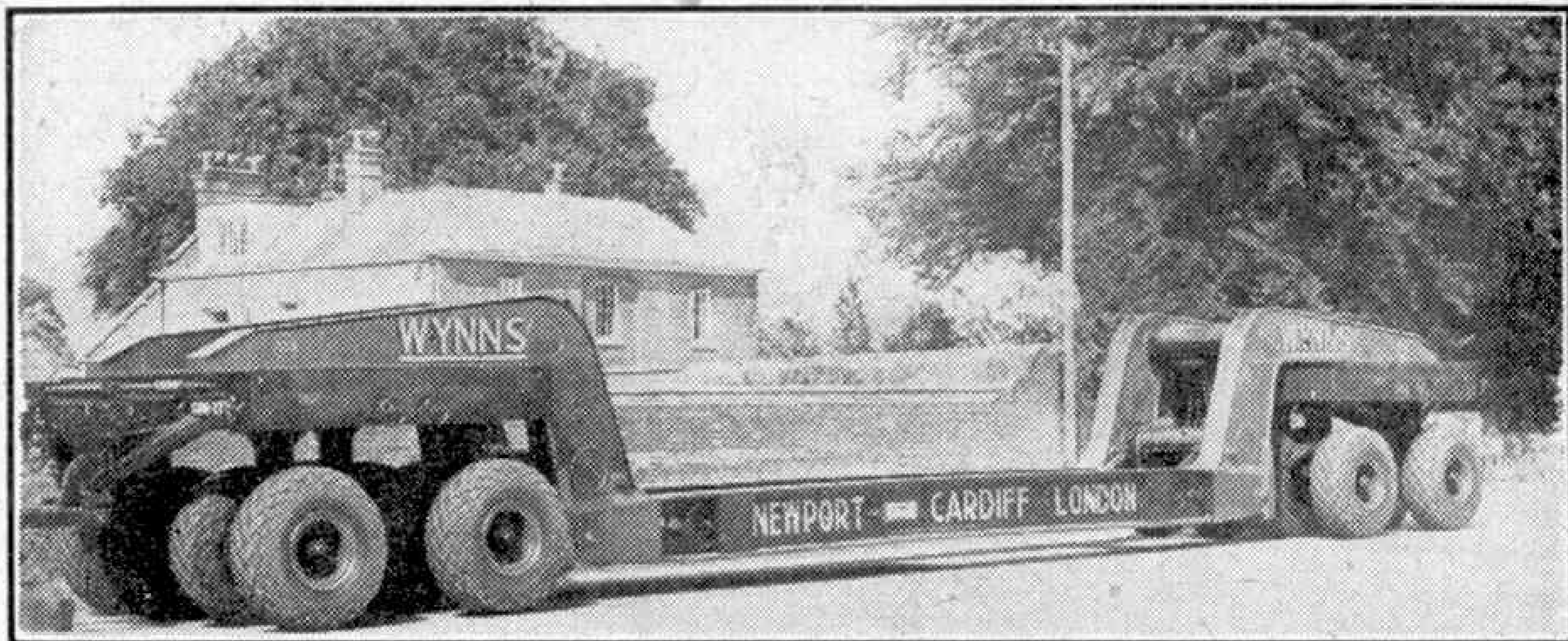

A Giant Road Trailer

THE 120-ton trailer shown above was built by Cranes (Dereham) Ltd. for Robert Wynn and Sons Ltd., Newport, Mon., who are heavy haulage specialists. It has already been used for many remarkable feats of transport. A notable one was the haulage to the docks, on its way to India, of the 2-8-2 locomotive built by the North British Locomotive Company for the Indian Government, that throughout last summer was shown at the South Bank Festival site. It was taken there by Wynn's, and could be moved by road only on this new trailer because of its length of 47 ft. 6 in.

The trailer has two eight-wheeled bogies, each carrying a swan-neck, and the two units so formed are connected by the main frame. The swan-necks have shovel mouth lower ends, in which the ends of the main frame are supported. The side members of the frame are coupled by flanged tubular cross members, as are the swan-necks.

The trailer can be altered in order to make it suitable for loads of different widths. A variety of frames is available, and the swan-necks can be moved to various positions to give overall widths from 4 ft. 6 in. to a maximum of 15 ft. 6 in. To allow for this there are six sets of tubular cross members, which either singly or in combination give the various widths of frame.

There are four short axles to each bogie, each axle being carried by a pair of wheels, and they are pivoted on the centre. Above the centre of each axle is a hydraulic ram that can be used to raise or lower the load in order to pass over humped bridges or to clear overhead bridges. This hydraulic suspension can also be used to tilt the vehicle if this is necessary to provide clearance or balance for the load.

The giant trailer has steering arrangements in the rear as well as in front and can be turned round within its own length. It can even be moved sideways, crab-like, for the axles of the bogies can be turned through a right angle.

Loading very heavy objects on the trailer is an interesting performance. The usual procedure is to lower the frame to the ground and to detach the swan-necks with their bogies. The load is then hoisted on the frame,

(Continued on page 94)

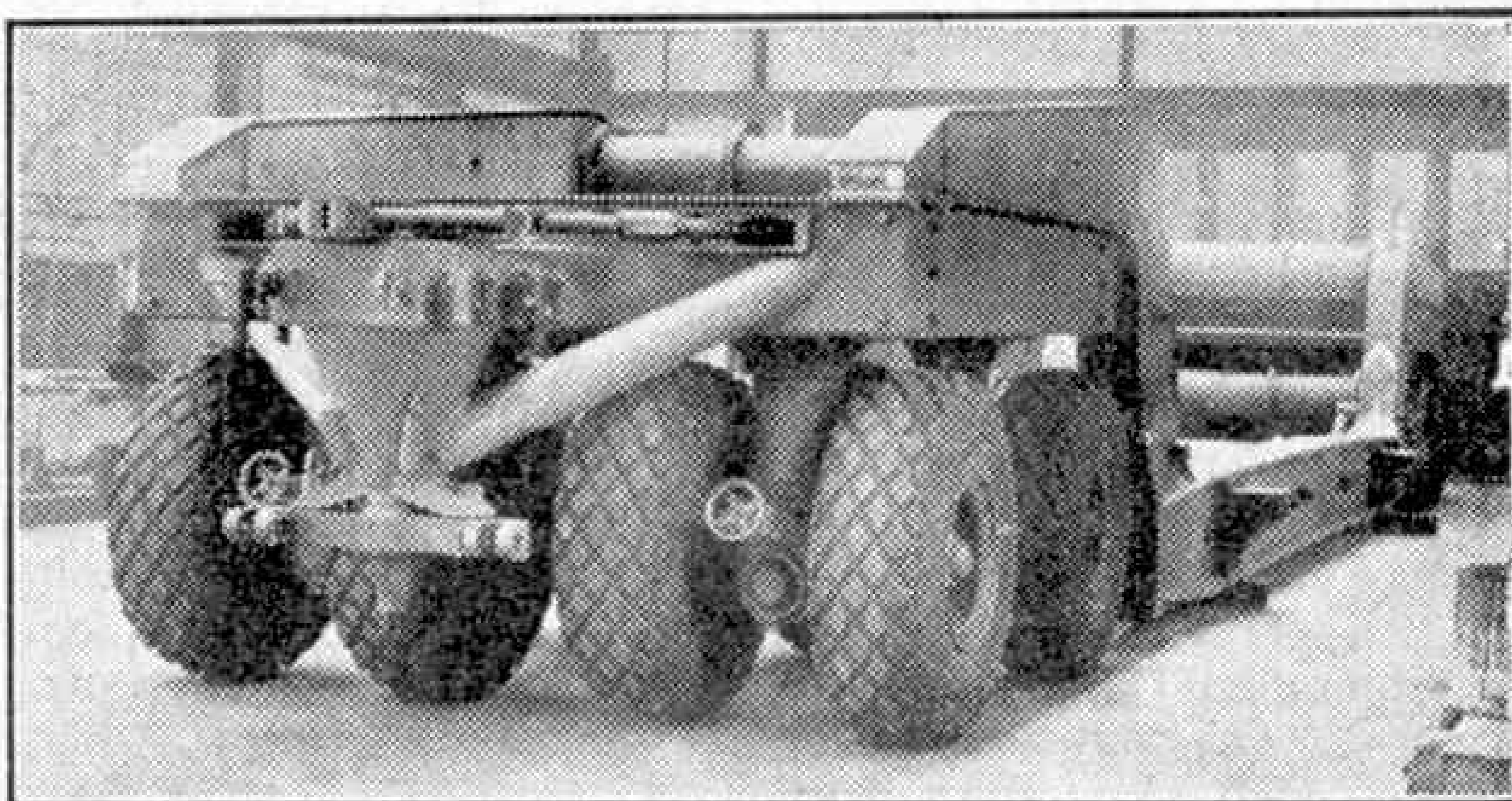

End view of the Wynn trailer seen in the illustration at the head of the page. Photographs by courtesy of Cranes (Dereham) Ltd.

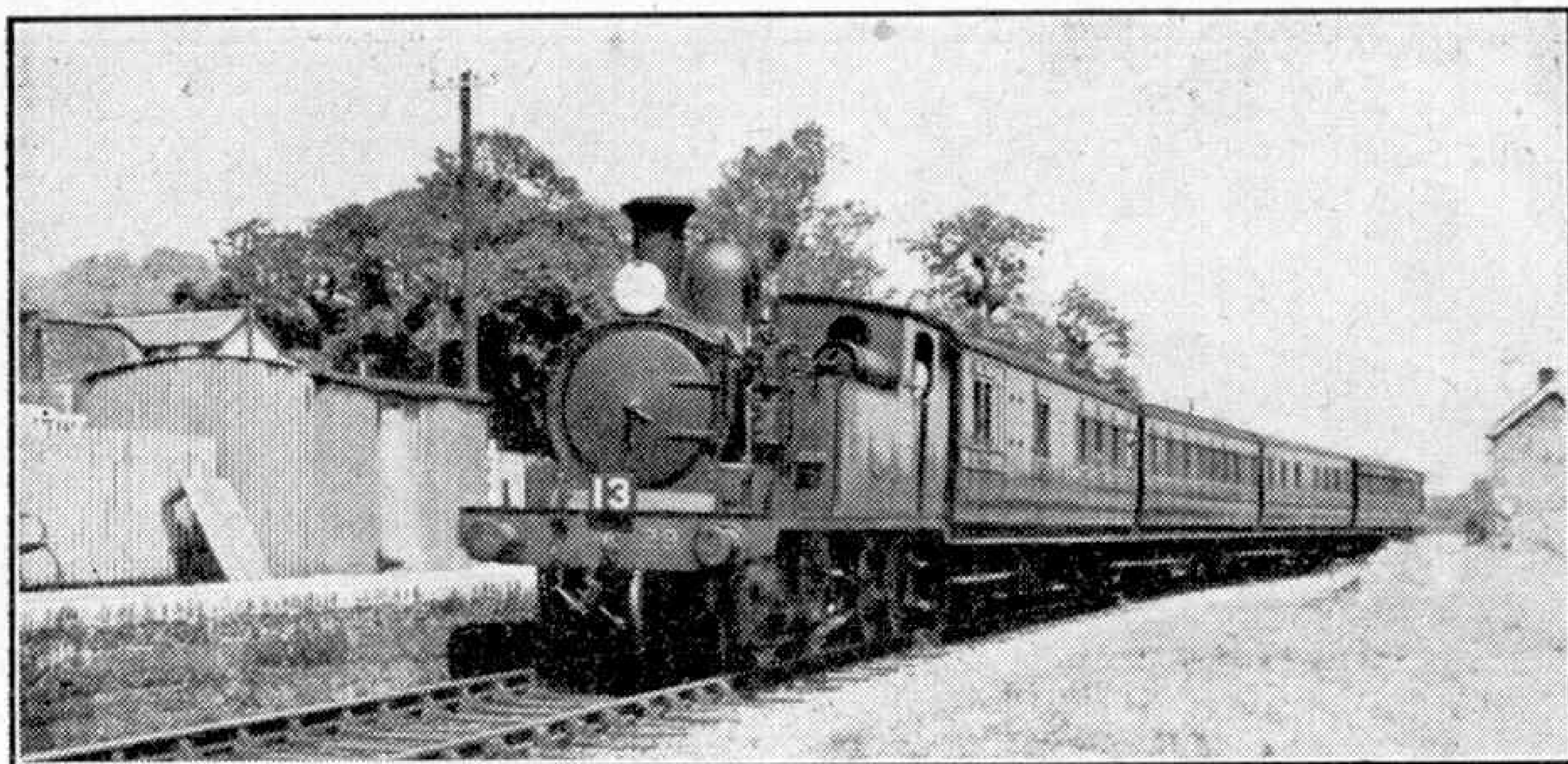

Isle of Wight Railways To-day

By R. A. H. Weight

A RATHER fascinating, detached section of the S.R. provides some 58 miles of railway in the Isle of Wight. Passengers from the mainland arriving at Ryde find a fully-equipped, four-platform station about half a mile out over the sea. The trains traverse a double line along the pier, with an electric tramway and a promenade alongside, call at Esplanade station, go through a short tunnel, and shortly afterwards reach Ryde, St. John's Road. At this station there is a small locomotive and carriage works on one side, and an engine shed on the other, together with sidings and stores.

In the country not far beyond, at Smallbrook Junction, a single line goes off westward to Newport. The main line to Ventnor, which carries the heaviest traffic, continues South, having become single line also. When Smallbrook Signal Box is closed in winter, the two tracks are operated as separate single lines thence to St. John's Road. Here there are signal posts on a gantry, to one or other of which semaphore arms appropriate to the current working are fixed. On the Brading-Bembridge branch is St. Helens Wharf, where heavy equipment is landed by means of shore cranes. At Bembridge a short, movable section of track enables engines to transfer to the running-round line within confined space.

The illustration at the head of the page, from a photograph by D. L. Bradley, shows a Freshwater train at Yarmouth, I.O.W., hauled by No. 29 "Alverstone."

Between Brading and Sandown there are two tracks again for $1\frac{3}{4}$ miles. Apart from the short stretches already mentioned, all the island railways consist of single track with passing loops at various stations. Five different systems of single-line working in use ensure safe operation and control the signalling, though the general principle is all the same.

Near Sandown good views occur of the coast and cliffs. Now comes a climb to Shanklin, another very popular resort. Then, on sharply-rising grades the route curves inland to Wroxall and so reaches Ventnor through a narrow tunnel three-quarters of a mile long that pierces the towering, chalky downlands rising steeply from the sea.

In the little seaside town of Ventnor there are two stations, high up on "ledges" about a mile apart. On a recent visit, travelling from the less frequented one, Ventnor West, in a two-coach local push-and-pull train to Merstone, I enjoyed from high ground a glorious view of the English Channel and the undercliff before turning inland to the centre of the island amid lovely country. From Merstone a Sandown branch train of four coaches took me to Newport, the railway headquarters and commercial centre, where I arrived in time to see one of the busy spells, with trains serving different routes. The one for Yarmouth and Freshwater, in the west of the island,

has to push out backwards to clear the junction before proceeding past the back of the station. At the south end are two parallel single lines on a swing bridge carried over the head of the Medina river. One of the illustrations shews the bridge open for the passage of a motor coaster going to unload near by.

The line to Cowes runs close to the river, serving wharves where most of the coal for all uses is unloaded and transferred to railway wagons as required. No ordinary freight or merchandise is conveyed nowadays apart from coal and railway stores, but there are considerable handlings of parcels, mails, passengers' luggage, etc., by passenger train in connection with the paddle steamers or new motor ships crossing frequently from the mainland. My circular tour was completed on

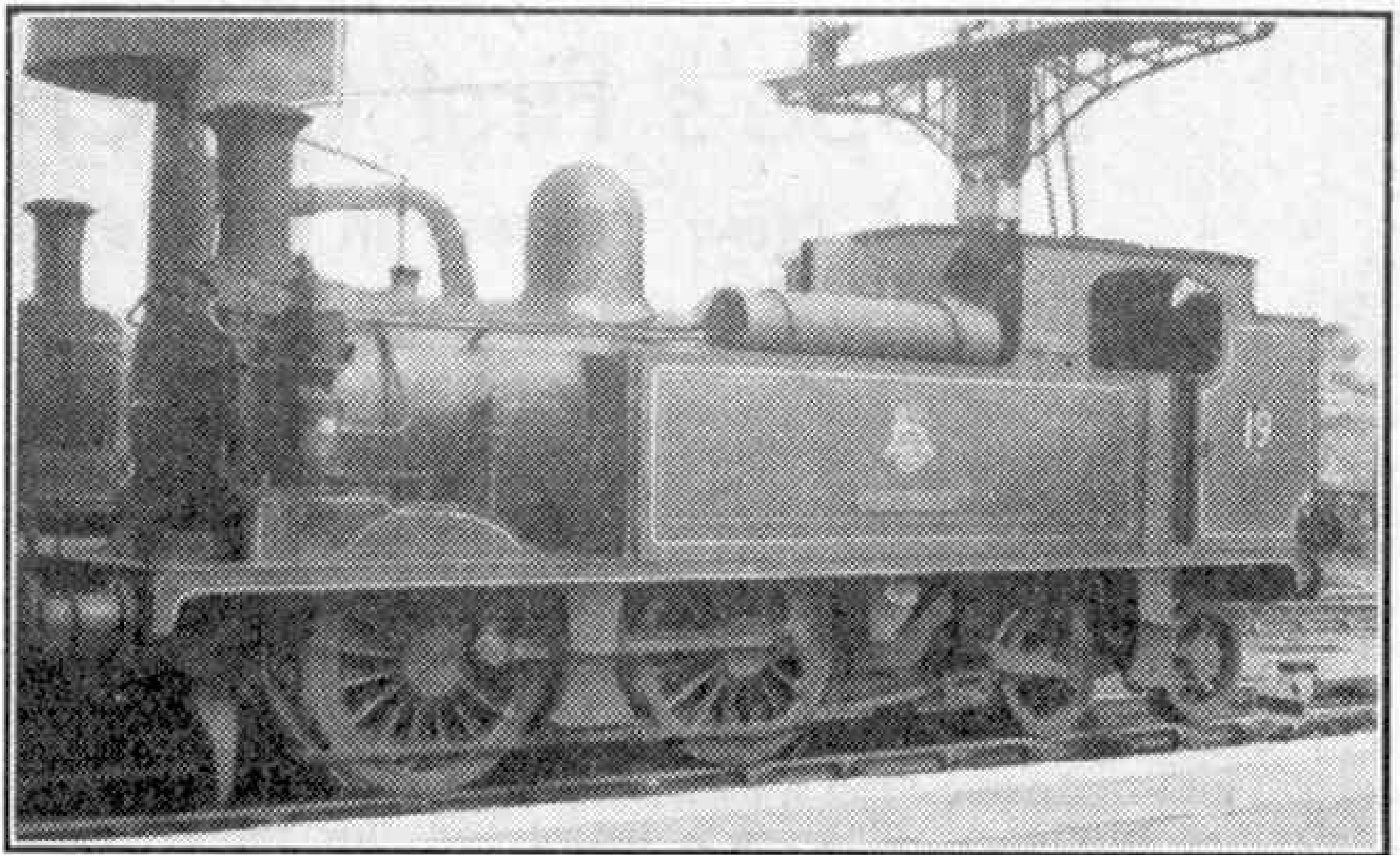

No. 19 "Osborne" ready to leave Newport with a passenger train. Note the Westinghouse brake pump and reservoir. Photograph by D. L. Bradley.

approaching Ryde from Newport, via the pretty Wootton route.

In summer there are ordinarily three trains an hour each way at Ryde stations, but this is increased to five at the Pier Head on Saturdays, when more than 2,000 passengers per hour may be conveyed. In winter services are slightly reduced. Throughout the year most trains are timed on a regular-interval basis. A high standard of punctuality is maintained in spite of the large proportion of single line, numerous gradients and curves, and the fairly frequent stops, for there are a good many country stations, often with nice gardens.

All the passenger locomotives have for some years been of the small 0-4-4T "02" class, designed about 60 years ago for the L.S.W.R. with 4 ft. 10 in. driving wheels. They are Nos. W14-W36, a separate series from other S.R. engines the prefix letter indicating their Isle of Wight posting. Formerly all were painted green; some still are, though British Railways black with lining is to be standard. They run chimney or bunker first, as required, hauling effectively a maximum of six bogie coaches on the main Ventnor route, or four on most other services. They have enlarged bunkers and some carry siren whistles. Nos. W35-6 can work "push-and-pull" trains.

There are also four ex-L.B.S.C.R. "E1" 0-6-0Ts Nos. W1-4, painted black and mainly used for coal trains or shunting. This makes 27 engines in all, of which 16 are normally shedded at Newport (71E), and 11 at Ryde (71F). All the engines carry geographical Island names, and are well maintained.

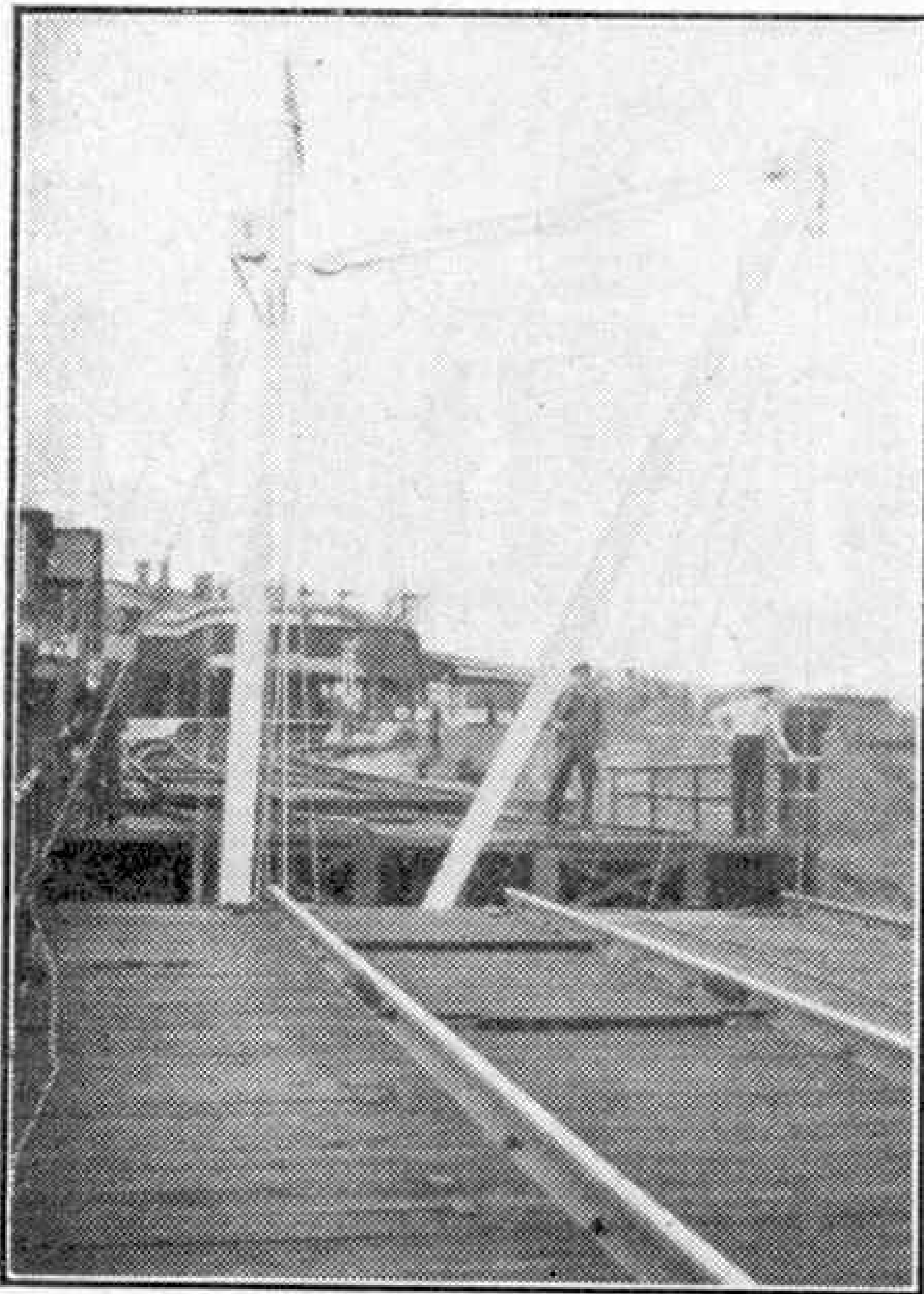

A special swing bridge at Newport with its moving section open to clear the mast and derrick of a small cargo vessel. Photograph by G. Howland.

Europe's First Cat-Cracker

A New Process in Oil Refining

A CAT-CRACKER has nothing to do with cats, and indeed the only things cracked with it, or rather in it, are not alive. They are just molecules, built up of atoms of carbon and hydrogen and known therefore as hydrocarbons. A cat-cracker is part of a modern oil refinery in which compounds of this kind, of which the oil chiefly consists, are broken down into simpler and lighter combinations of carbon and hydrogen atoms, as part of the process of producing high-grade petrol.

The first cat-cracker to be built in Europe was completed last year at Pernis, Rotterdam, in Holland, and others are now either under construction or in operation at refineries in Great Britain. The Pernis cat-cracker is seen in colour on the cover of this issue, and a general view of this part of the Pernis Refinery is shown in the illustration on this page.

The name given to this refining unit is what has been called a portmanteau word, that is one made by fusing two words together after shortening one or both of them. In this instance one of the two words is "cracker," which means a plant that breaks up heavy hydrocarbons into lighter and simpler ones, as already explained. The "cat" is short for "catalytic." It indicates that the cracking is carried on with the aid of a substance that itself is not really changed, but somehow succeeds in making the cracking easier. Such a substance is called a catalyst.

Now let us see how catalytic cracking came into use. The oil that comes out of the ground in any of the oil-bearing regions of the world is a sluggish liquid that may be greenish, black or brown, and is occasionally almost colourless. It is difficult to imagine that in it we have the liquids that we know as petrol and paraffin, both of which flow readily and easily, or that it yields other products

such as vaseline and even paraffin wax. Yet they are all there, and extracting them from the crude oil and refining them is to-day one of the most gigantic industries in the world.

The beginning of all this dates back to the drilling of the first oil well nearly 100 years ago by Colonel Drake at Titusville, Pennsylvania, in the United States. This was long before the days of motor cars, but even at that time there were demands for the riches hidden in the oil, notably for kerosene, or paraffin, which was largely used for heating and lighting purposes, and it was then that refining began. Now of course petrol, at first an encumbrance because it could not be used as a lighting or heating oil, has become the chief product, and fuel oil also has outstripped paraffin.

The earliest refining was carried out by simply heating to vaporise the oil, with

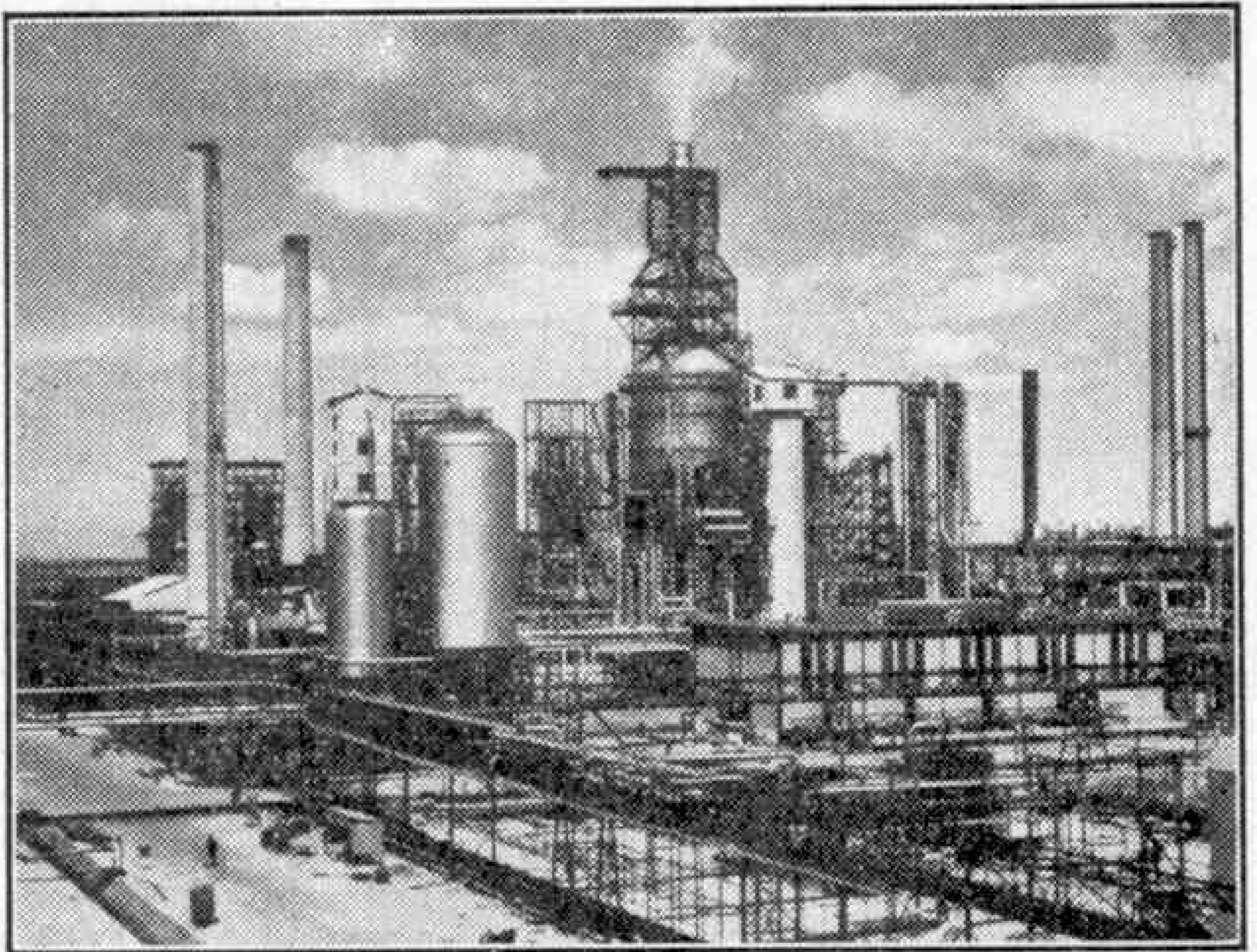

The cat-cracker at the Pernis Refinery. The rectangular structure is the catalyst regenerator, and the fractionating column is on its right. On the left is the 196 ft. chimney stack of the furnace.

arrangements for condensing the vapours. A pure substance like water, which consists of a single chemical compound, has a definite boiling point, which we all know as 100 deg. Centigrade or 212 deg. Fahrenheit. Crude oil is a mixture of many chemical individuals, however, and has

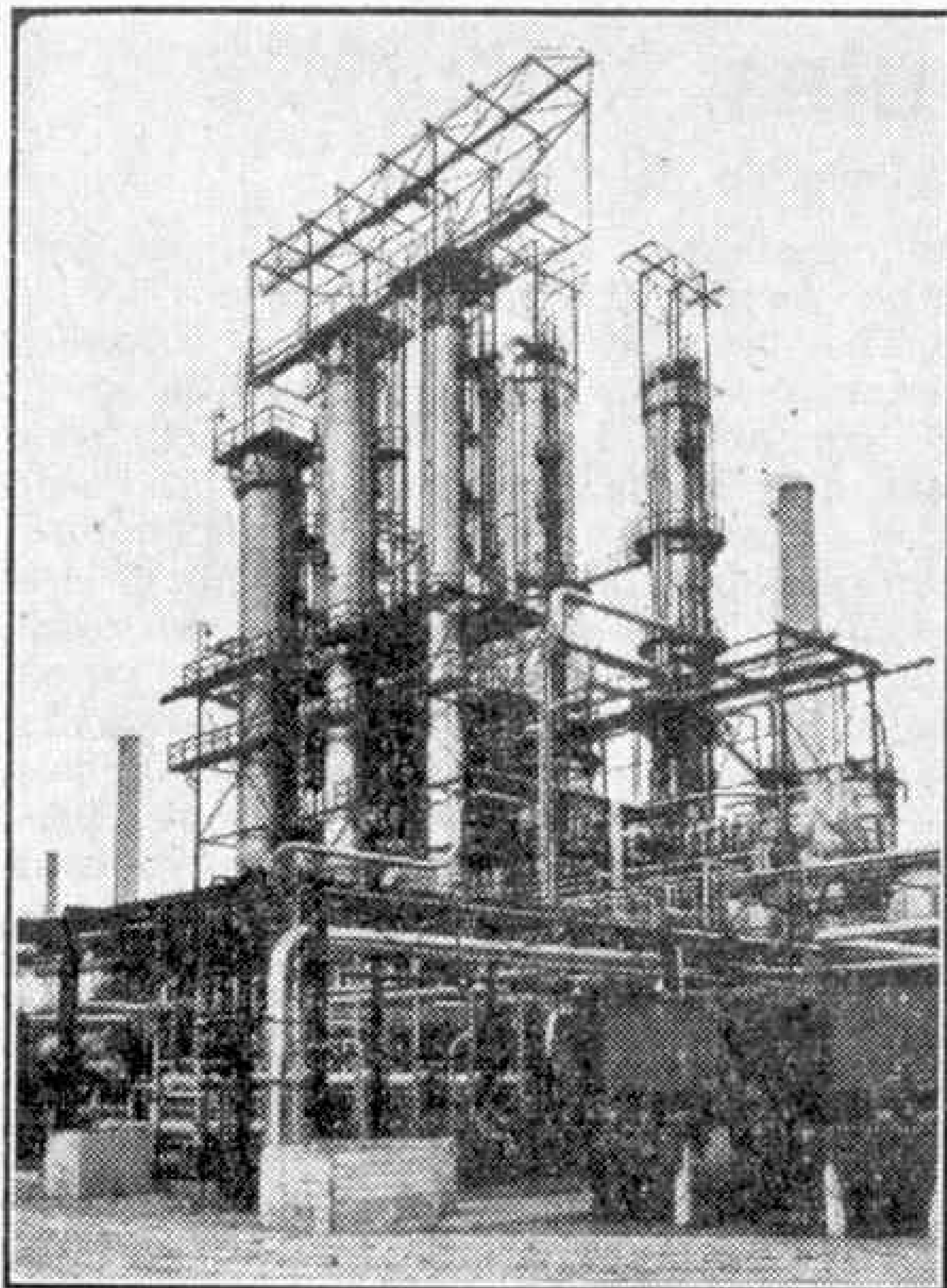

The crude oil distillation plant at Pernis, which has a throughput capacity of 6,000 tons a day.

no single boiling point. When it is heated the first vapours that are produced are those of the simplest and lightest hydrocarbons. As the temperature rises heavier compounds that have progressively higher boiling points are successively changed into vapour, and so on. These fractions of the oil are condensed separately to give petrol, paraffin, fuel oil and other products of this kind.

Because it separates the hydrocarbons in the oil into fractions this distilling process is called fractionation and is now continuous. The heating is carried out in a tube-still heater, in which the oil flows through a tubular coil in a heating chamber, and the actual separation is made by leading the vapours into what is called a fractionating column. This is a metal cylinder with baffle plates in which the vapours cool as they rise up it. The heavier compounds cool and condense first and are tapped

off in the lower sections of the column, while the lighter products pass successively higher up before becoming liquids. At the end of the scale of products is a gas, which is carried away at the top of the fractionating column.

It was soon discovered that heating the crude oil to a temperature higher than that needed for distilling it produced a greater proportion of illuminating oil and petrol. The reason for this is that the greater heat broke up, or "cracked," the heavier compounds in it, as explained at the beginning of this article.

The earliest cracking plants employed this method, and thermal cracking, as it is called, became a key process in oil refineries. But just before the war came a rival, a very efficient one that was brought into use just in time to produce enormous quantities of aviation fuel of high quality for the Allied air Forces.

In this new process the oil vapour is passed through a bed of a suitable earth, which acts as the catalyst and breaks up the vapour into gas, petrol, lighting oil and fuel oil at a lower temperature than in thermal cracking. The new method has the further advantage that it gives better products, while in addition the catalyst takes up the carbon that is formed when the oil is heated. The earth becomes less active, but it can readily be regenerated by burning off the deposit of carbon, and put to use again.

We are indebted to The Shell Petroleum Company for the photograph on which this month's cover is based, and for the information given in this article and the illustrations on these pages.

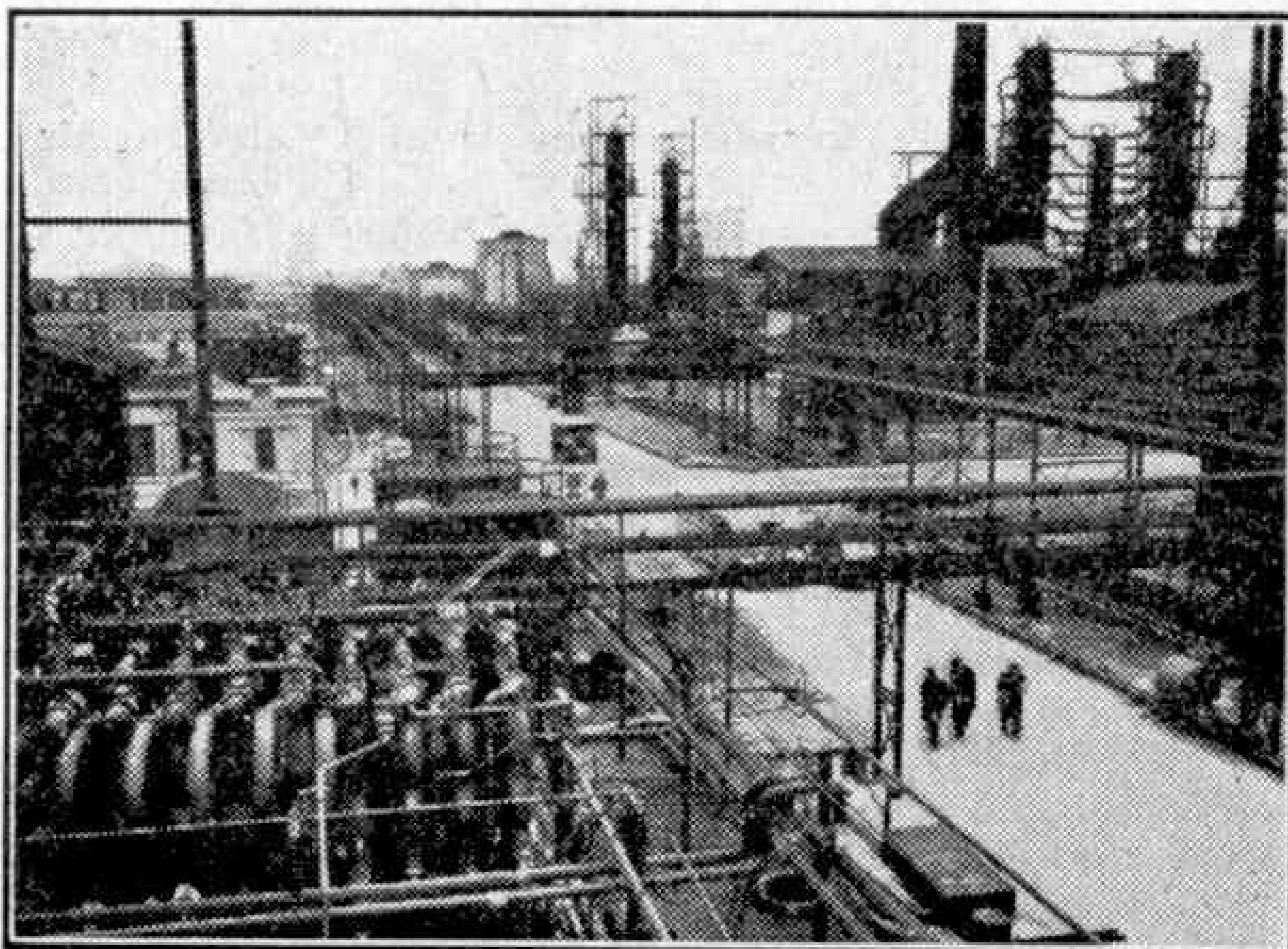

A main road through the Pernis Refinery, with overhead piping for steam supplies, and product pipelines at ground level.

Parachutes

By John W. R. Taylor

PARACHUTES started as a joke many hundreds of years ago, when rich Chinese hired professional acrobats to jump from balconies with the aid of large umbrellas, as a prelude to the after-dinner entertainment of their guests. But parachutes are far from a joke to-day. During the last war they saved tens of thousands of lives by enabling airmen to escape from crashing aeroplanes; and they helped to kill tens of thousands of people by lowering two atomic bombs

and usefulness is as fascinating as any other section of aviation history.

The first person to foresee a really practical use for parachutes was the great Italian artist Leonardo da Vinci, who was also a great scientist and engineer and designed the first helicopters, aeroplanes, army tanks and submarines some 500 years ago. But it was not until the first man-carrying balloons were built in 1783 that the parachute really came into its own. The reason is obvious

when one remembers that those balloons were little more than big silk and paper "bags," wafted into the sky by hot air rising from fires lit under their open end. Quite a lot of early aeronauts discovered too late that it was difficult to collect enough hot air without setting their balloons alight, with the result that they returned to earth much more quickly than they went up, followed by clouds of smoke and burning silk.

Obviously there was need for a

device that would bring them down more gently, and the Frenchman Andre Garnerin set the fashion when he made his successful parachute descent over Paris in 1797. The only snag was that the 'chute rocked so violently on the way down that he was sick. But Garnerin soon learned to overcome this by cutting a small hole in the top through which air could escape instead of "spilling" from under the edges of the parachute.

Six years later Jordski Kuparento became the first airman to save his life by parachute, when he jumped from a blazing balloon; and he was only the first of many. But 19th century 'chutes were so unreliable that the total of demonstration jumpers who had been killed rapidly outnumbered the serious aeronauts whose lives were saved. This



British paratroops landing at Arnhem, Holland, during the second World War. British Official Photograph, Crown Copyright.

slowly and surely to where they would do most damage.

Now fresh uses for parachutes are being found almost daily; not only in air warfare, but in our other battle against the unsolved hazards of flying at the speed of sound. And parachuting is fast becoming a major sport, with its own annual international contest and a string of officially recognised records.

The 'chutes used for these purposes are very different from the umbrellas used by the ancient Chinese, who would probably have been horrified if someone had suggested that their "parachutes" would work better if they had a hole in them. Yet nearly all modern parachutes have a hole in the top, and the story of how it got there, and of how parachutes reached their present state of efficiency



The tail parachute brake of the Martin XB-51 jet bomber reduces the landing speed, enabling the aircraft to touch down on comparatively small airfields. Photograph by courtesy of the Glenn L. Martin Co., U.S.A.

helped to account for the popularity of the demonstrations, but had the opposite effect on the popularity of the parachute among balloonists.

In fact, as late as the 1914-18 war, 'chutes were still so unreliable that it was not considered worthwhile issuing them to Allied pilots on the Western Front. They were, however, supplied to officers who went up as observers in baskets slung under kite balloons. As a result, when a fighter pilot shot down a kite balloon he often watched its occupant float down to safety at the end of a parachute, knowing that if his own aeroplane were set on fire he would have no such means of escape.

The chief difficulty was to find a way

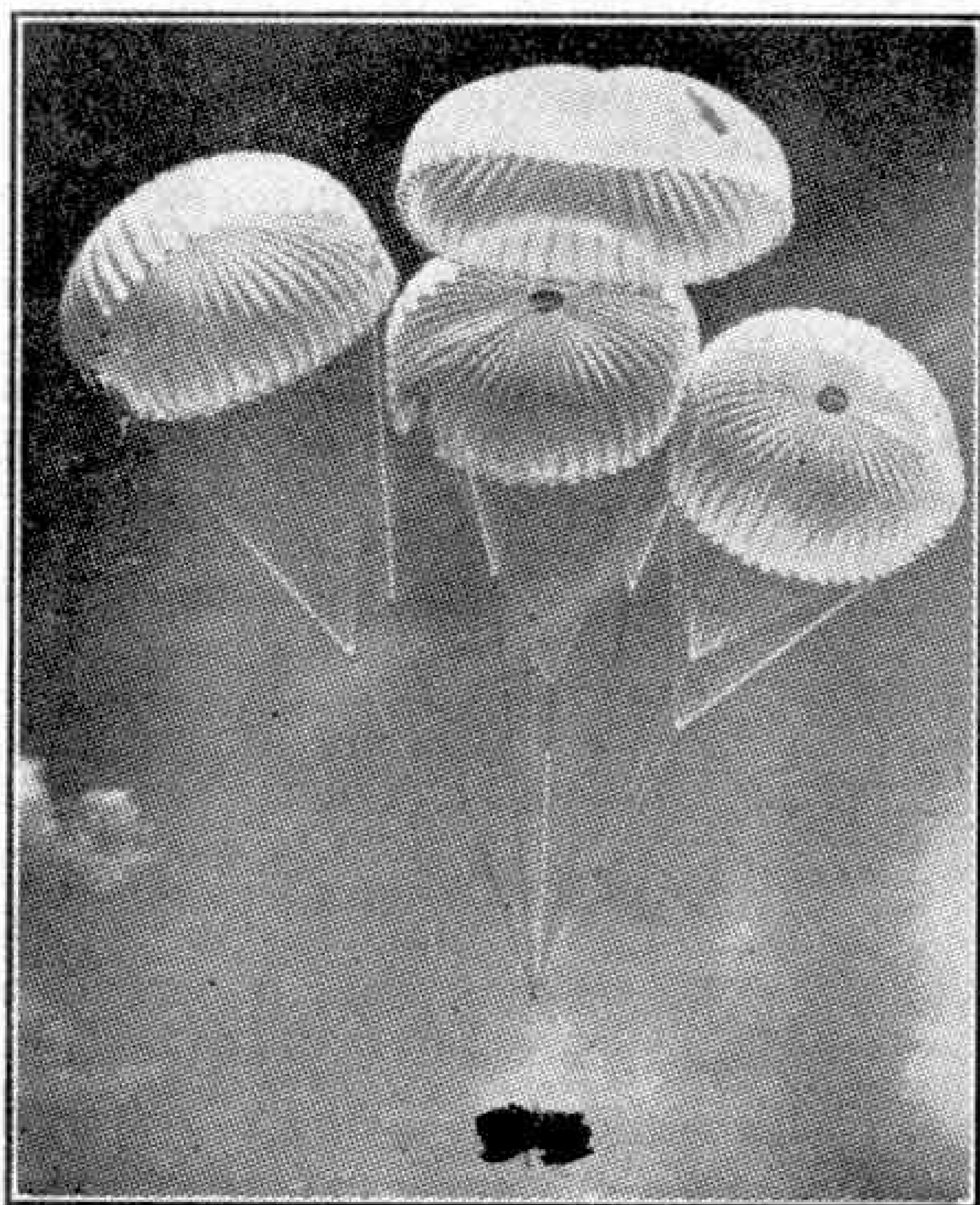

Army vehicle "dropped" from a transport aircraft in flight being brought down safely by parachutes.

of ensuring that a pilot's parachute would open without getting entangled with his aeroplane. The basic design of parachutes had changed little in 100 years, and they were still pulled open by a cord attached lightly to the balloon basket or aeroplane. What was needed was a parachute that could be opened by a pilot when he was well clear of his 'plane; but nobody seemed able to suggest a way of doing this. Nobody, that is, except a young American named Leslie Irvin.

Although only 24, Irvin was an old hand at parachuting, having gained his balloonist's licence at 16, graduated to parachute jumping and then become a stunt man for Universal Films, with the colourful nickname of Ski Hi Irvin. In 1919, before representatives of the U.S. Government, he jumped from an aeroplane wearing a new-type parachute pack, which he opened after dropping for several seconds by pulling a "rip-cord" to release a small parachute, which in turn pulled out the main 28 ft. canopy.

His free-fall 'chute was adopted at once by the U.S. Government, and in 1925 by the R.A.F. To-day Irvin parachutes of the same basic design are in regular service in 42 countries, and have been used millions of times in training and on operations; yet no undamaged Irvin Air Chute has ever failed to open when required.

There are other famous makes of parachute, too, including the British G.Q., American Pioneer and the remarkable ribbon-chute perfected by German scientists in World War II. Between them they are doing a variety of jobs far beyond the wildest dreams—or nightmares!—of old Andre Garnerin.

The chief aim is still to get people down from great heights in one piece; but even for this comparatively simple task there are several different types of 'chute. For

example, a fighter pilot has little room to spare in his cramped cockpit, so to save space his parachute pack is designed for use also as a seat cushion. Despite its small size it can contain a rubber dinghy and survival kit as well as the 24 ft. dia. silk parachute. A seat pack would get in the way of a bomber crewman, who has to be able to move around during flight; so he usually wears only the harness, to which a quick-connector chest parachute pack can be clipped rapidly in an emergency. But both these types are now being replaced by a flexible, streamlined pack which airmen can wear on their back permanently without inconvenience.

For the civil pilot or passenger who wants safety combined with comfort there is the Irvin Chairchute, which looks like any other aircraft seat, but has a quickly-attached parachute built into its back. And, of course, for the jet-fighter pilot there is another kind of seat—the ejector type—to shoot him clear of his aeroplane if things go wrong. To use it, he first jettisons his cockpit hood, then pulls down a blind over his head, which simultaneously fires a cartridge to shoot him out, complete with seat, and protects his face from the slipstream at high speeds. At a safe distance from the aircraft, a parachute attached to the seat opens automatically. Later, the pilot leaves the seat and makes a normal descent with a second parachute.

Such seats have already saved several lives, but designers believe that before long, in an emergency, the pilot will be able to stay in his cabin, which will detach itself completely from the rest of the 'plane and float down to earth under one or more big 'chutes. This would solve the problem of "baling out" at supersonic speeds or high altitudes where there is insufficient oxygen to keep a man alive.

Free-fall 'chutes have not replaced entirely the old type opened by a cord attached to the aircraft, and these "static-line" parachutes are still used when dropping airborne lifeboats, "sticks" of paratroops and military supplies.

Surprisingly heavy loads can be delivered in this way, ranging from Jeeps and field guns to 9½-ton bulldozers. Usually such heavy equipment is lashed to a platform which can be pushed out of the aircraft during flight on rollers, and the parachutes are attached to this platform.

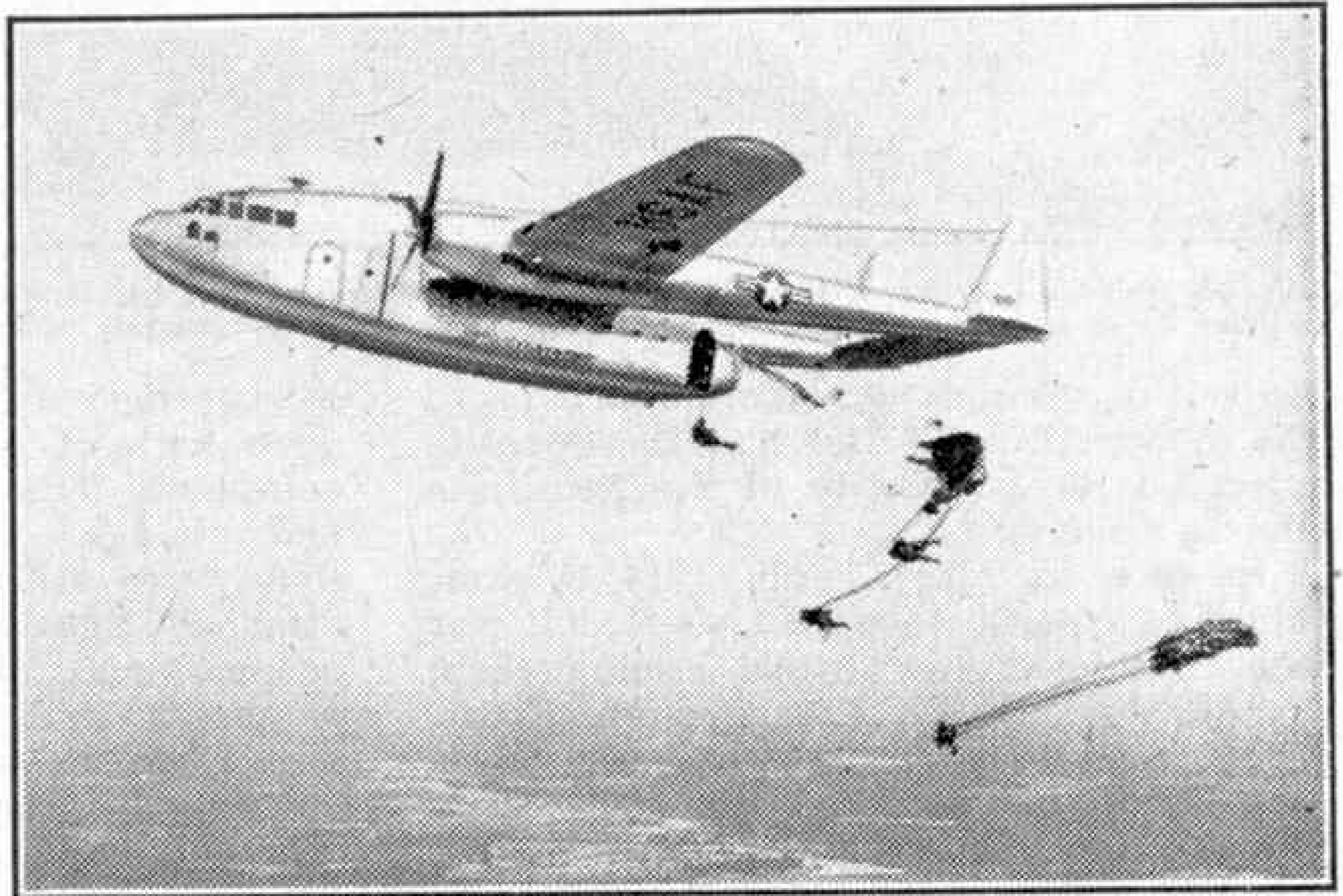

U.S. paratroops parachuting from a Fairchild C-119 transport aircraft. Photograph by courtesy of the Fairchild Aircraft Division, U.S.A.

To reduce the shock of landing, the base of the platform can be sprung or fitted with a pneumatic cushion, and the U.S.A.F. are working out methods of dropping a big gun complete with its crew, all in one "parcel."

Ribbon 'chutes, in which thin strips of material alternate with thin strips of space, are being used more and more for this work, as they open with less shock, and tests have shown that three cheap 28-ft. square cotton ribbon parachutes will do the work of one of the very expensive 64-ft. nylon 'chutes previously used for heavy drops. They have also proved invaluable as braking parachutes, to slow down high-speed aircraft landing on short or icy runways.

In fact, parachutes are playing a big part in helping to solve the problems of high-speed flight research. The little Fairey F.D.1 delta aircraft, for example, has two small parachutes in wing-tip containers as well as its tail braking 'chute, their purpose being to pull it out of an accidental spin. Other parachutes, designed to open automatically at a pre-determined height or time, are used to "rescue" delicate instruments and cameras carried miles into the air by research rockets.

BOOKS TO READ

Here we review books of interest and of use to readers of the "M.M." With certain exceptions which will be indicated, these should be ordered through a bookseller.

"FELLOWSHIP OF THE AIR"

By B. J. HURREN (Iiffe. Price 30/-)

In the Editorial of the September 1951 "M.M." tribute was paid to the Royal Aero Club on its 50th birthday. Now the whole story of this great Club has been told by Lt. Cdr. B. J. Hurren in a splendid book entitled appropriately "Fellowship of the Air." It is difficult to imagine a more thrilling subject, for this is a story of people rather than things—of the men who gave Britain her first wings and then went on to establish our leadership in the skies of peace and war. It is illustrated with 88 historic photographs, many of which have never been published before.

The story begins in an era when the aeroplane was still no more than an inventor's dream and balloons sailed the skies. It gives inside accounts of such events as the Schneider Trophy races and great record flights of the 1920s and 30s, and brings the story right down to our own time, when the Club is doing so much to keep alive our tradition of private and sport flying in an age of supersonic flight and rockets.

This book will delight every boy interested in aviation—and his father! So if its price is beyond your reach, ask your local library to get it for you; it will never be on their shelves long enough to get dusty!

J.W.R.T.

"MINIATURE LANDSCAPE MODELLING"

By JOHN H. AHERN

(Percival Marshall and Co. Ltd. 10/6)

Here is a book that provides most of the answers to practically all the scenic problems that face the indoor miniature railway constructor. It is written from the point of view of the owner of a permanent miniature railway system; but many of the principles can be applied in the construction of scenic items for portable layouts.

The subject of baseboards and substructure is dealt with first. Then follow chapters on the landscape foundation and the scenic treatment of the "ground." Roads, waterways and trees are considered in a manner that shows how the author captures the elusive realism that is so desirable for these features. The landscape generally, backgrounds and lighting are considered in turn, and the final chapters take the reader into the realm of ultra miniature modelling.

Methods and materials bulk largely in the text, and the many sketches and other illustrations show the finished articles and constructional stages in their development.

"RALLIES AND TRIALS"

By S. C. H. DAVIS (Iiffe. Price 15/-)

Almost every boy at some time longs to be a racing motorist or the driver of an express train, and eagerly reads all he can of the lives of men who have attained these "exalted" positions. This enthralling book, therefore, will be sure of a great welcome from "M.M." readers who are motor racing enthusiasts. It is the work of an internationally famous racing and trials driver with over 30 years' experience, and it abounds in thrills and lively stories of his adventures and mishaps while taking part in the Monte Carlo Rally, the world's greatest motoring event. He writes also of his experiences in the hair-raising Alpine Trials, of the brilliant French Rallye Gastronomique, of the fun that goes with driving in the "Old Crocks' Race"—the annual London to Brighton run for veteran cars organised by the Royal Automobile Club—and of other trials and events in which he has taken part.

The book is lavishly illustrated with 32 pages of pictures in photogravure, showing some of the cars taking part in the trials and races, the men who drove them, and some of the mishaps that occurred.

"ANIMALS STRANGE AND RARE"

By RICHARD OGLE (Bell. Price 12/6)

This book will delight the young nature lover who wants to learn about the immense variety of strange and rare fish, reptiles, birds and animals that exist today, some of them living links with the amazing creatures of pre-historic times. It contains a wealth of fascinating detail about close upon 300 different creatures of the Earth, and in describing them in their native haunts the author ranges from Australia and New Zealand to Madagascar, and from the forests of the Amazon to the mighty Himalayas.

Mr. Ogle is a talented artist as well as narrator. Nearly 100 of the creatures dealt with are illustrated by his own line drawings.

"THE A.B.C. OF BRITISH RAILWAYS LOCOMOTIVES"

(Ian Allan Ltd. Pts. 1-4, 2/- each)

"M.M." readers will welcome the appearance of these "A.B.C." booklets, dealing with the locomotives of four British Railway Regions. They are revised and corrected up to Autumn 1951, and follow the usual "A.B.C." style, giving classified lists in numerical order of British Railways motive power units.

It is necessary to explain that Part 1 covers W.R. steam locomotives only; owing to the B.R. numbering scheme the non-steam locomotives, irrespective of regions, are included in Part 2 with S.R. steam and electric stock. Part 3 lists L.M.R. electric motor coaches and steam locomotives. Part 4 is a real "omnibus" edition, including all former L.N.E.R., W.D. and new British Railways standard steam locomotives, and the E. and N.E. Region electric train units.

"SOCCER FOR BOYS"

By F. N. S. CREEK

(English Universities Press. 6/-)

This is a fine addition to the "Junior Teach Yourself" series. Mr. Creek knows football as a player of skill and distinction, and he also understands the art of writing about it for boys interested in the game.

The subject is introduced by the story of a visit to the ground of the Arsenal F.C., after which there is a brief account of how Association football has grown into the world-wide sport of today. The laws of the game follow, but not in a dull statement of them; instead the author explains them, with instances from play, and he makes good use of illustrations that can best be described as pictorial diagrams.

These preliminaries settled, we then have talks on kicking, dribbling, passing, heading and other football activities, all dealt with very simply but in an entirely practical and reasonable manner. Tactics on the field are then explained, after which we turn to the special requirements of different positions. Lessons from famous matches complete an attractive book.

"A CHRISTMAS CAROL"

By CHARLES DICKENS (Ward, Lock. 8/6)

All "M.M." readers who have enjoyed Renown Pictures' film "Scrooge," from Charles Dickens' famous classic "A Christmas Carol," will delight in this film edition of the story. It is printed in large, clear type and illustrated with four beautifully reproduced colour plates and 60 photographs from the film. Readers who have seen the film will remember that Alastair Sim plays the part of the miserly business-man Ebenezer Scrooge, who one Christmas is visited by three spirits, the Ghosts of Christmas Past, Present and Future. In turn they take him on a series of ghostly visitations that make him realise what a despicable character he is and finally convert him into a kind-hearted gentleman.

Railway Notes

By R. A. H. Weight

New Style Uniforms for Railway Staffs

The Railway Executive announce the issue of smart new uniforms for British railwaymen and railwaywomen that are to be introduced gradually. The standard patterns are to be in dark blue cloth with gilt, chromium or black buttons. Only thirteen different qualities of cloth will be needed in future, compared with 38 at present. The material will be shower-proofed when used for overcoats and caps.

Peaked caps will be worn by men, with metal badges displaying the British Transport Commission emblem or the British Railways totem in the appropriate Regional colour. Guards, ticket collectors and others who come into contact with the public are having an indication of their grade on the cap badge. For women the peaked cap has been replaced by a darted beret in blue cloth, with silver piping round the front.

High Voltage Trials on L.M.R. Electric Line

Trials are being carried out on the short Lancaster-Morecambe-Heysham lines, which were originally electrified experimentally by the former Midland Railway in 1908, taking current at 6,600 volts and 25 cycles from overhead cables. After 40 years of service the original equipment had become worn out and the electric service was discontinued in February last year. As mentioned in these notes some months ago, steam push-and-pull services worked by the modern 0-4-4Ts numbered 41900-4 were substituted.

In the course of the trials now decided upon, the overhead voltage will be varied from 6,600 up to and including 20,000, and tests will be made with various types of equipment. The British Transport Commission reports on electrification recently recommended a traction system for secondary lines in which current is fed directly to the trains at high voltage. This plan introduces special problems, but has several advantages, including the use of a lighter overhead installation, fewer and simpler substations, and the absence of power cables along the track. For main lines carrying heavier traffics the 1,500 volts d.c. system was recommended, as installed and now being extended on the Eastern Region.

News from the Eastern and North Eastern Regions

New engines lately placed in service were allocated as follows: "B1" 4-6-0, Nos. 61380-1, 38A, Colwick, and Nos. 61382-8, 37A, Ardsley; L.M.R. type class "4" 2-6-0, Nos. 43142-5, 31D, South Lynn, Nos. 43146-51, 32G, Melton Constable, and Nos. 43124-8, 53A, Hull, Dairycoates; L.M.R. type class "2" 2-6-0, Nos. 46473-82, 51A, Darlington, or its sub-sheds at Kirkby Stephen and West Auckland for steeply graded branch line working.

More electric main line locomotives in the 260xx series have been completed. Additional "A3" 4-6-2s at 35B, Grantham, are Nos. 60056 "*Centenary*" and 60112 "*St. Simon*," moved from Doncaster.

Two "Battle of Britain" 4-6-2s numbered 34076 and 34089 have been on loan to Stratford from the Southern Region while the "Britannia" class engines were withdrawn for examination and tests.

Former G.C.R. class "C13" 4-4-2Ts are still used on the Chesham branch at the time of writing, and are also seen on carriage shunting duties round about Neasden or Marylebone.

More excellent timekeeping has been observed and reported along the East Coast route. Some of the "A3s" still take an important share. The 44 or 43 min. start to stop timings over the 44 miles from Darlington to York were already the quickest in this country, and achieved with heavy loads, but an even faster booking has been given this winter to the afternoon Newcastle-Birmingham express. This is allowed 42 min., requiring a 63 m.p.h. average along this famous stretch of main line, electrically signalled and fairly straight, with only a slight downhill inclination and a good deal level.

With 13 on, or 450 tons full, "A1" No. 60129 "*Guy Mannering*" on a 43-min. allowance was recently timed to cover the 38½ miles from leaving Darlington to passing Beningborough in 34½ min., and would have been in York in 41 min. but for a signal check outside. "A3" No. 60074 "*Harvester*" was slightly quicker than this with 390 tons, while with no less than 545 tons, 15 heavy coaches, the streamlined "Pacific" No. 60025 "*Falcon*" was within 42 min. overall on one occasion, averaging 74 m.p.h. for 25 miles.

The lighter "*Tees-Tyne Pullman*" is allowed only 41 min. to pass York from Darlington start and is one of the fastest British long-distance trains to-day.

"A1" No. 60157 now carries nameplates "*Great Eastern*" with coat-of-arms.

By the withdrawal of the last surviving

examples the following classes have become extinct: ex-G.N. "D3" 4-4-0, the last of which was No. 62000; "Q4" Great Central outside cylinder 0-8-0, of which 89 were built from 1902 onward, the thirteen rebuilt as "Q1" 0-8-0T remaining; and "Q5," the somewhat similar North Eastern type, of which there were several varieties owing to reboiling or other alterations. Many of the last-named class carried the grenade symbol of the Royal Engineers, indicating that they served overseas during the first world war. The only 0-8-0 tender class still in service are "Q6-7" of the Raven N.E. two and three cylinder series.

A novel type of signal bridge or gantry is in use at an important junction near Ryhope Grange signal box, which has been equipped with a new 65 lever frame. The recently completed gantry is of girder construction, with eight tubular steel posts, bearing 14 signal arms, and two platforms, from the lower of which the cranks and operating connections are easily accessible for maintenance. The upper platform, also extending across the width of four tracks, provides direct access to ladders and lamps. The signal arms,

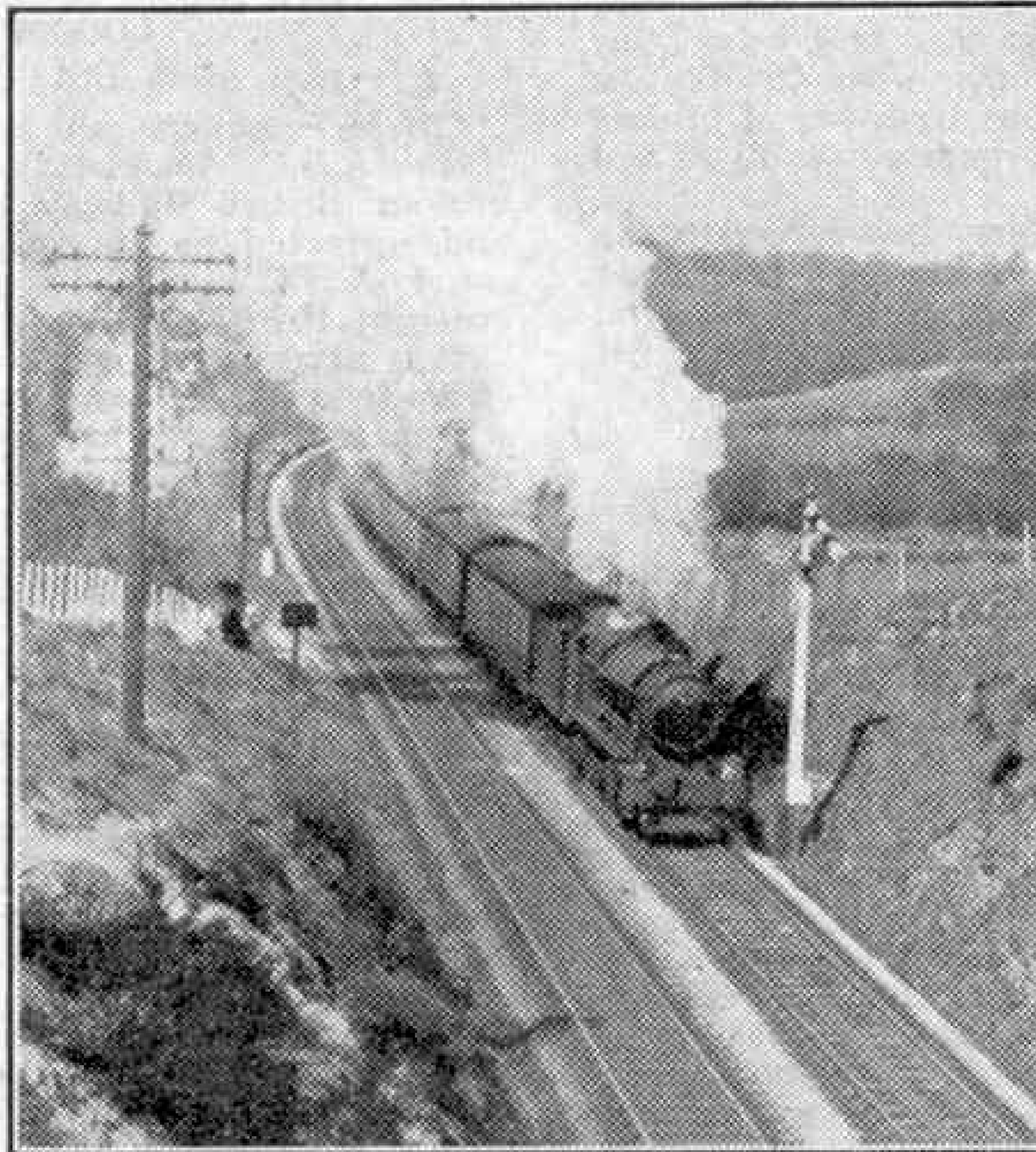

B.R. No. 1018 "*County of Leicester*" climbing Dainton incline with a Western Region express. This photograph, one of the entries in a recent "M.M." Competition, was taken by M. E. Ware, Woodbury, Nr. Exeter.

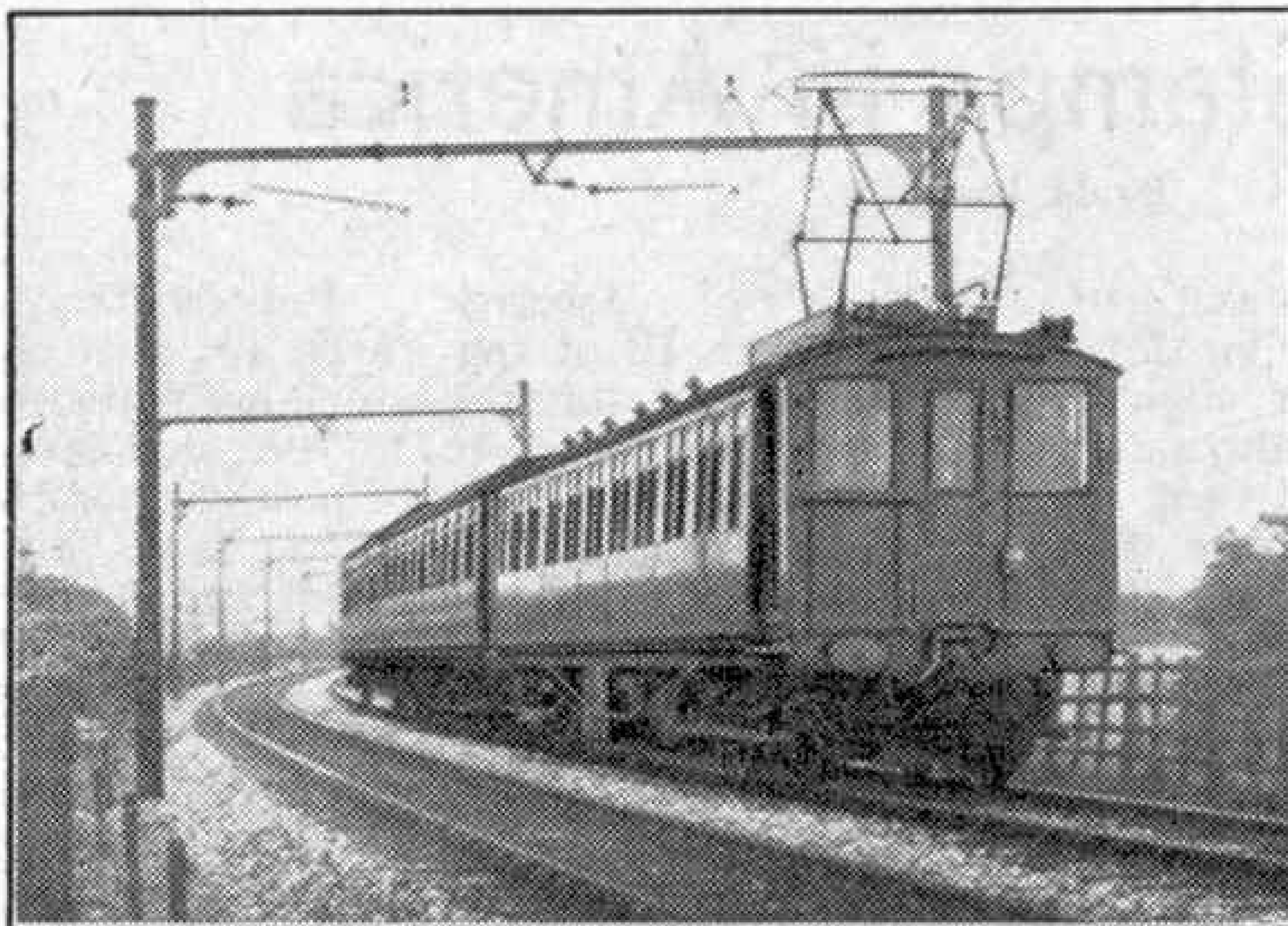

A typical scene on the Morecambe-Heysham line when operated on the 6,600-volt overhead electrification system, now discontinued. Photograph by W. S. Garth.

which are fewer in number than on the preceding structure, have been kept to a minimum in height in order to be as clearly visible as possible in all weathers. The position is south of Sunderland on the Leeds-Newcastle main line via the coast.

New Station at Girvan, Ayrshire

The station buildings at Girvan, on the way from Glasgow and Ayr to Stranraer and the grand scenery of south-west Scotland, were completely destroyed by fire in 1946. Opportunity has been taken in rebuilding to provide what may be regarded as a model station of the latest type in brick and pre-cast stone construction. It has heated halls and office accommodation, a glass fronted booking office with Hygiaphone windows and adequate messing facilities, newly devised and convenient ticket equipment and parcels and cupboard space. There are also spacious rooms for the Stationmaster and staff.

Southern Tidings

I have been favoured by Mr. Fred H. Smith with logs of several first-rate runs by Bulleid "Pacifics" with substantial loads on the early evening West of England express from Salisbury to Woking and Waterloo which calls at Andover Junction. Taking the "Battle of Britain" trips first, No. 34052 "Lord Dowding" on a crowded, 13-coach train weighing over 460 tons behind the tender, left Salisbury 26 min. late, but recovered 14 min. in the course of the 83½ mile journey to Waterloo, including an average of 71.3 m.p.h. over the last 22 miles before the Woking stop. The speed at Basingstoke was moderate owing to a severe signal slowing at Worting Junction, where the Bournemouth main line is joined and a very fast travelling stretch begins for up expresses.

No. 34049 "Anti-Aircraft Command" with 12 on, weighing about 400 tons gross, accelerated well and with a clear road to the outskirts of Woking averaged no less than 76.8 between mile posts 52 and 26, with several maxima of 80 m.p.h. "Merchant Navy" No. 35009 "Shaw Savill" with 13 on also

gained time, enjoying a clear road to Hampton Court Junction, 13 miles from Waterloo, while probably being worked a good deal more easily than the two light 4-6-2s previously mentioned, though high speeds were enjoyed.

No. 35008 "Orient Line" similarly loaded, made a grand start from Salisbury uphill, covering the 17½ miles from Andover stop in barely 20 min. Several minutes were regained so promptly that matters could be taken more easily thereafter, but the recorder on the Western Division can usually be sure of some excitement and fast running in the course of main line runs.

During November last the diesel-electric 2-6-6-2 express locomotive No. 10202 began regular weekday operation of two round trips between Waterloo and Exeter, successfully hauling the 1.25 a.m. and 1.0 p.m. down fast trains, returning with the 7.30 a.m. and 5.53 p.m. from Exeter Central to London, covering 687 miles per day.

Locomotive Building for Overseas Railways

Building firms in Britain continue to be busy with construction in compliance with orders from overseas. Among examples lately completed and shipped by the Vulcan Foundry Ltd. were 20 powerful oil-fired, 3-cyl. 4-6-2s for the haulage of heavy, fast expresses in the Argentine to and from Buenos Aires. In association with the English Electric Company the Vulcan Works have also produced 15 heavy mixed traffic electric locomotives of 3,000 h.p. for service in Brazil; these are claimed to be the most powerful of the kind built here. The gauge is 5 ft. 6 in., as it is also on the Ceylon Government Railways, for which system Messrs. W. G. Bagnall Ltd. constructed six 4-8-0 engines that had to be of a specially light weight type, with no axle load exceeding 9 tons.

Thirty Vulcan Foundry 4-8-2s have been delivered for the 3 ft. 6 in. gauge Gold Coast Railway.

In the diesel-mechanical realm, an interesting 8-coupled locomotive, intended for handling cotton and general freight trains over extremely severe gradients in Peru, has been successfully tested with loads above the usual single engine limit on the L.M.R. over steep inclines in the Leeds-Guiseley area. The builders were the Hunslet Engine Co. Ltd.



A B.R. Standard 4-6-2 on Southern duty. No. 70009 "Alfred the Great" speeds along with the "Bournemouth Belle." Photograph by R. Knight.

Making Stamps in America

By M. Lorant

FOR convenience the postage stamps of the United States are listed in three groups. These are ordinary or regular series stamps, commemorative stamps and memorial stamps. The first set of commemorative stamps, known as the Columbian Series, was issued in connection with the World's Fair in Chicago in 1893. Since then practically every event of importance in which the Government has participated by Act of Congress has been recognised by a special set of postage stamps. In addition, there have been many stamps to commemorate anniversaries of important historical or industrial events associated with the development of the whole of the United States.

The Famous Americans series of postage stamps of 1940 represents the most extensive single set of postage stamps of a special nature authorised to date. This series included 35 different stamps bearing portraits of individuals who achieved distinction in the arts and sciences. The stamps were arranged in seven groups, of representative artists, authors, composers, educators, inventors, poets and scientists.

A noteworthy series of special postage stamps was also issued in co-operation with the Washington Bicentennial anniversary and placed on sale on 1st January 1932. In this there were 12 stamps in denominations of $\frac{1}{2}$ c. to 10c. inclusive. The designs were modelled from portraits of Washington painted from life by the outstanding artists of his time. Although the Washington Bicentennial stamps are classed as commemorative, they largely displaced the regular issue stamps in these denominations during the period of celebration, which continued until the end of that year. In addition, a set of commemorative stamped envelopes was provided for this anniversary.

The issue of National Parks stamps of 1934 is unique in that it represents the first separate series of stamps ever authorised by the Department showing outstanding scenic views in various

sections of America. Representative scenes from 10 of the Parks are seen on the individual stamps, which were issued in denominations of 1c. to 10c., inclusive.

An enormous number of postage stamps is required each year to meet the requirements of the United States, the yearly average now being in excess of 19,000 million stamps, having a face value of approximately 700,000,000 dollars. Of this quantity, not less than 15,000



Engraving the steel master die is the first step in the making of a stamp. The engraver cuts the design in soft steel, which is then hardened.

million are of the 1, $1\frac{1}{2}$, 2 and 3-cent. denomination.

When it is desired to issue a new postage stamp, either regular or commemorative, the U.S. Bureau of Engraving and Printing are asked to prepare a model. This follows such suggestions as the U.S. Post Office Department may furnish, and photographs or drawings that may be considered suitable for use as subject matter on the stamp also are submitted. The material is then placed in the hands of a trained designer, who prepares a model in black and white for consideration. Additional models may be called for until one is found to be satisfactory.

The accepted model is approved as indicated by the signature of the

Postmaster General and is returned to the Bureau of Engraving and Printing for the next step, which is the engraving of the master die. This consists of cutting the design in reverse into a piece of soft steel from which, when completed, prints of the proposed stamp are pulled in desired colours to be presented to the Postmaster General for final approval of the design and the shade of ink to be used in the printing. These prints are known as die proofs.

After approval of the die proof, the master die is hardened by heating to a temperature of about 1,400°F. in a cyanide solution from 7 to 10 min., followed by immersion in a brine bath.

The hardened master die is then placed in a transfer press where, under heavy pressure, the design is impressed on a soft steel roll. After hardening in the same manner as the master die, this is used in transferring the design to the steel plates employed in the printing of the stamps. The plates are hardened by being heated for about 10 min. at 1,550°F. and

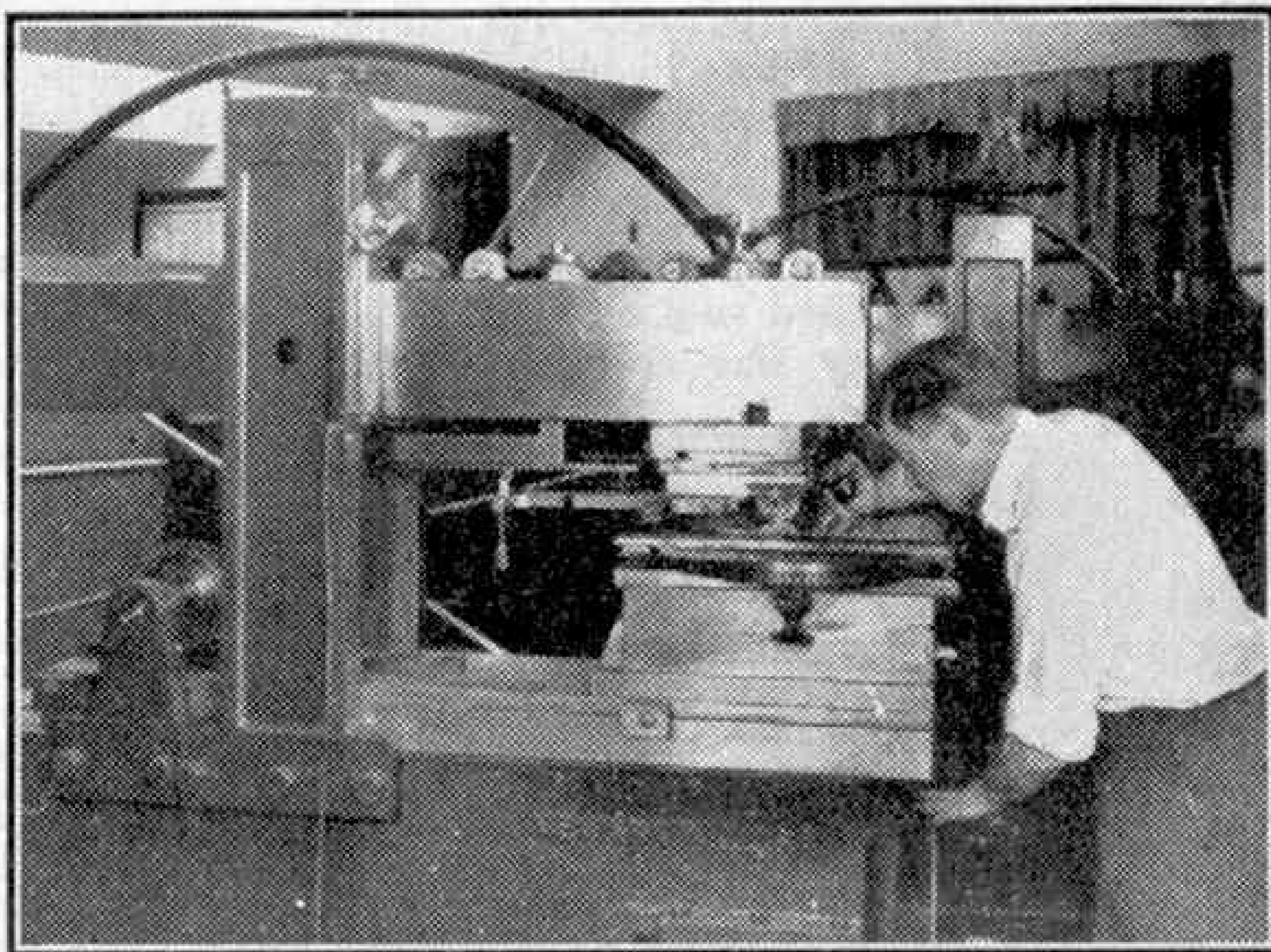

The design is transferred from the hardened master die to a steel roll, which itself is then hardened and used for making the steel plates used in printing.

containing 200 or 400 stamp impressions each, depending on the size of the stamp. The operations of inking, wiping, polishing, feeding and delivery of the impressions are carried out by a printer and two helpers. The printer polishes the plates, one girl feeds the press, and another removes the printed sheets. The presses have a capacity of approximately 4,000 sheets daily, or 1,600,000 stamps if the plates contain 400 subjects.

After being printed, the sheets are coated with an adhesive on a gumming machine by contact with a metal roller, which revolves in a solution of gum. They are then carried automatically through an electrical drying chamber in which the gum is hardened in less than 30 sec. The gum is made from dextrine, which is of vegetable origin, and is relatively free from taste and odour.

The printed and gummed sheets of 400 stamps are next fed through a rotary perforating machine that perforates the sheets in one direction and cuts them in half. Another machine of the same construction completes the perforating and cuts the halves to sheets of 100 stamps each.

After rigid inspection, these sheets are carefully counted and verified, and finally made into packages for shipment to post offices throughout the United States. There are now approximately 45,000 post offices in operation, and all stamp

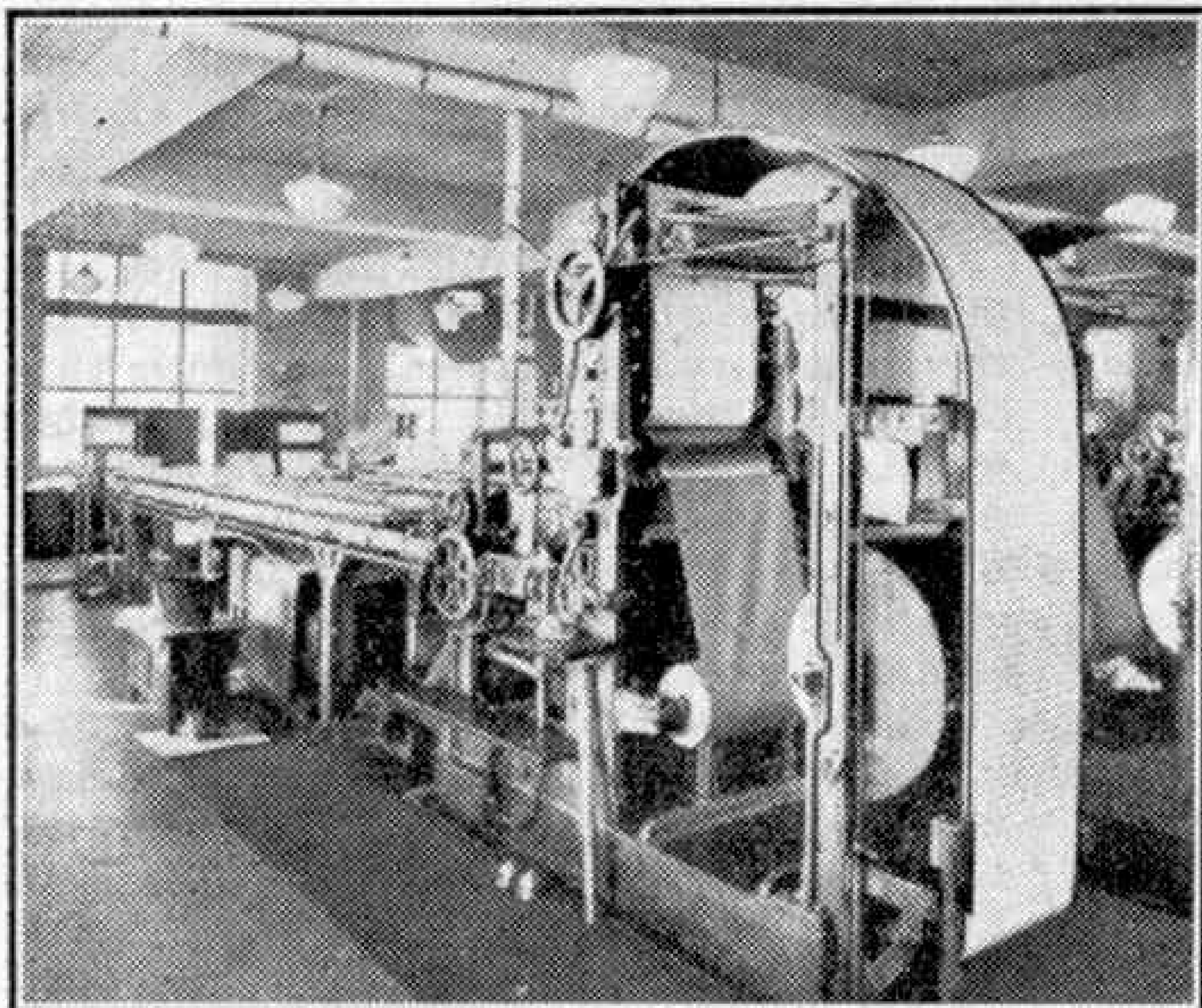

A large rotary press that prints 800 stamps at each revolution.

immersed first in oil and then in brine.

Postage stamps are printed in two different designs of printing presses, known as the flat bed and rotary presses. The flat bed printing is accomplished on power presses fitted with four plates

shipments to them are made by official registered mail to obviate losses in transit.

At the present time all stamps, except a few of the higher denominations and bicoloured issues, are printed on rotary presses. These are equipped with two curved plates attached to a cylinder which prints 800 ordinary size stamps at each

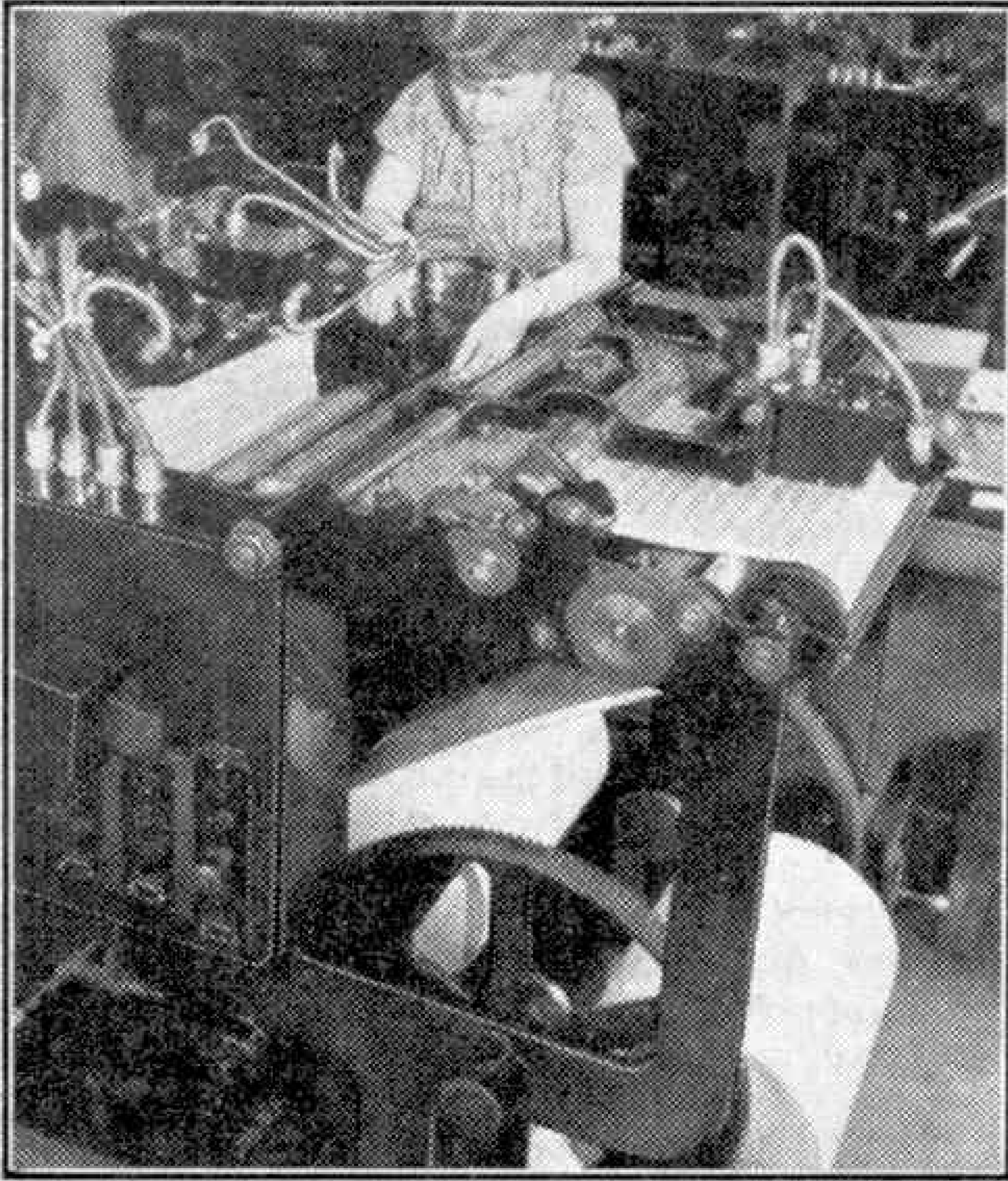

In this machine, used for perforating the sheets of stamps, a photo-electric cell or "electric eye" detects variations in the width of the paper and makes adjustments to ensure that the lines of small holes fall in the right places.

revolution. The capacity of a rotary press is approximately 7,800 plate impressions daily, or nearly twice that of a flat-bed press and, in addition, the rotary printed stamps are gummed and ready for perforating. The presses use paper from a roll and are constructed so that the printing, gumming and drying of the ink and gum are completed automatically. The web of printed stamps is rewound to roll form at the opposite end of the press.

After the printed web is thoroughly dry, it is fed into a special machine that perforates the stamps in both directions and cuts the web to sheets of 400 subjects. Following this, these large sheets are examined and assembled in units of 100 sheets each, and the count is verified. These 100-sheet units are stitched in four places in the margins on a special, four-head stitching machine and subsequently are cut to quarter sheets, the size in which delivered.

For collection purposes, it is desirable to have well-centred stamps. Perfection in this regard is not possible, however, due to the fact that the paper must be softened by wetting with water before printing to make it more flexible and more easily forced under pressure into the fine lines of the steel engraving, which contain the ink. The introduction of water into the paper causes it to expand, the expansion being proportional to the amount of water added.

It is not always possible to introduce the same amount of water, so that variations in expansion occur. As the paper is printed while in an expanded condition, the variation in expansion of the paper will be reflected in differences in the width and length of the printed web. To compensate for these variations, means of adjusting the perforating mechanism become necessary.

Formerly this adjustment was performed by hand. This resulted in a high percentage of mutilated stamps and the necessity for placing in circulation many poorly centred stamps. The Bureau of Engraving and Printing has now developed perforating machines in which the adjustment is controlled photo-electrically.

In order to provide for this automatic control, register marks are engraved on the printing plates and appear on the sheets of stamps in the form of dashes. These dashes are scanned by photo-electric cells which, in conjunction with a multiplicity of electronic tubes, activate the necessary mechanical elements that control the positioning of the perforating wheels and bars. This new method of perforating stamps has materially improved the centering of the perforations and greatly reduced the number of rejected stamps.

Government postal cards were first issued on 1st May 1873. They are now manufactured at the Government Printing Office in Washington, D.C., by means of high-powered, modern printing presses with a capacity of 250,000 completed cards per hour. Approximately 6,000 tons of paper are used in printing the yearly supply of more than 2,000 million postal cards required for postal service.

Stamped envelopes were first issued in June 1853. Envelopes bearing the purchaser's printed return card were authorised by law in 1865. The average yearly issues of stamped (Cont. on page 94)

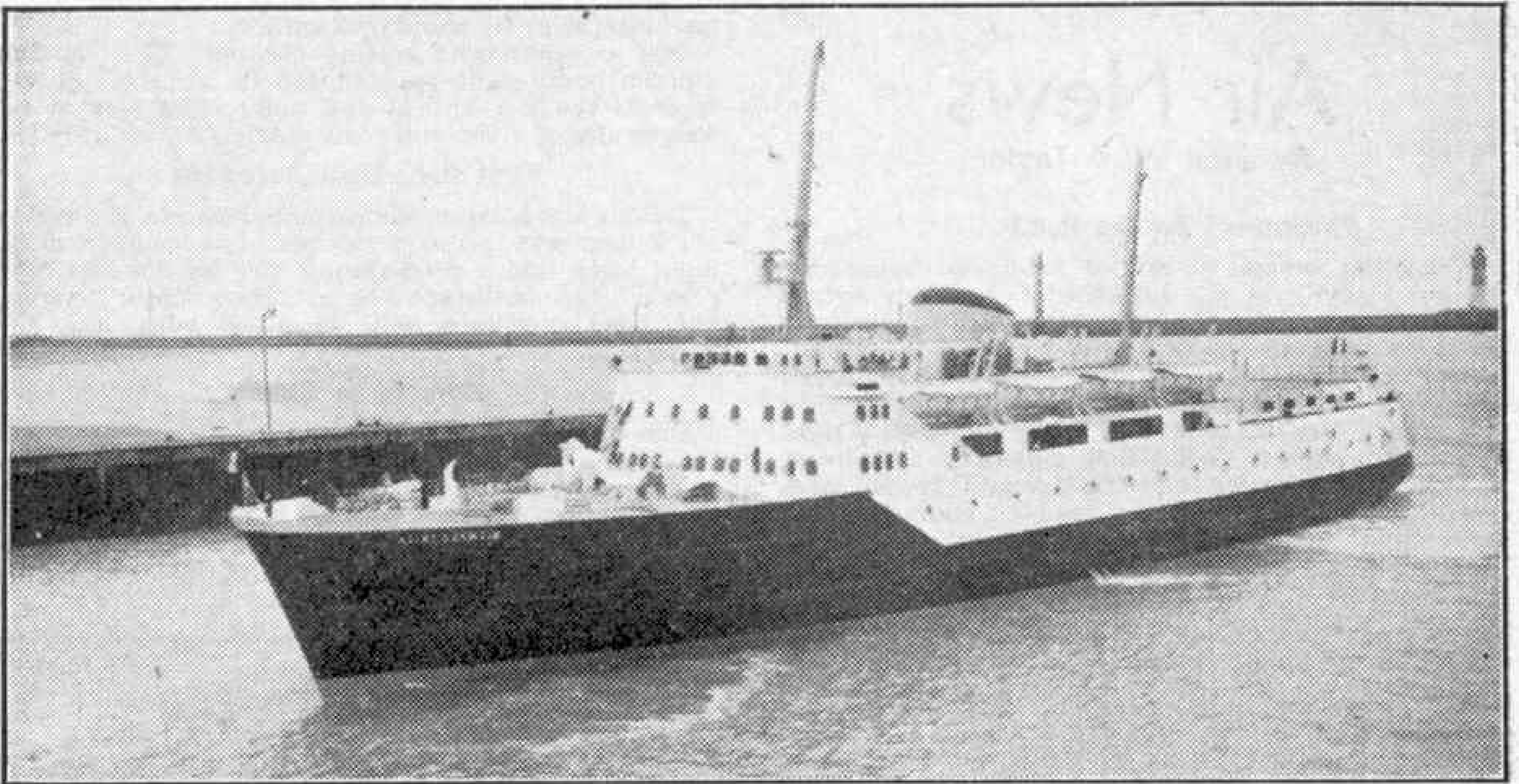

The "Saint Germain"

LAST July a new vessel was introduced on the cross-channel train ferry service between Dover and Dunkirk. This was the twin-screw "*St. Germain*," built by the Elsinore Shipbuilding and Engineering Co. Ltd., Denmark, for the French Railways. The vessel differs from the others engaged in the service in that she is driven by diesel engines instead of steam turbines.

The "*St. Germain*" is modern in design, with a well-raked stem, a low streamlined funnel, and a superstructure with a rounded front. Her length overall is 379 ft. 8 in., her overall breadth 62 ft. 2 in., and her dead weight tonnage 1,300 at her loaded draught of 13 ft. 6 in. Her engines are of 9,600 h.p. and give her a speed of 18 knots. There is accommodation for a total of 500 passengers, 248 of whom can be provided with sleeping berths.

The promenade deck has a garage for 24 motor cars at the after end, and below it is the train deck, which has four rail tracks arranged to give the greatest possible total length. The two inner tracks are capable of taking the sleeping cars of trains between Great Britain and the Continent. The train deck is sheathed in wood up to rail

height, so that when necessary space can be used for carrying motor cars.

The "*St. Germain*" is required to manœuvre smartly when completing her crossings. At Dover she must proceed stern first up the harbour and into a lock specially built for the service, in which the water level can be adjusted. At Dunkirk she passes through a sea lock into the harbour and then moves stern first to the loading ramp. To allow for ready handling the vessel therefore has been provided with a rudder at the bow as well as one at the stern.

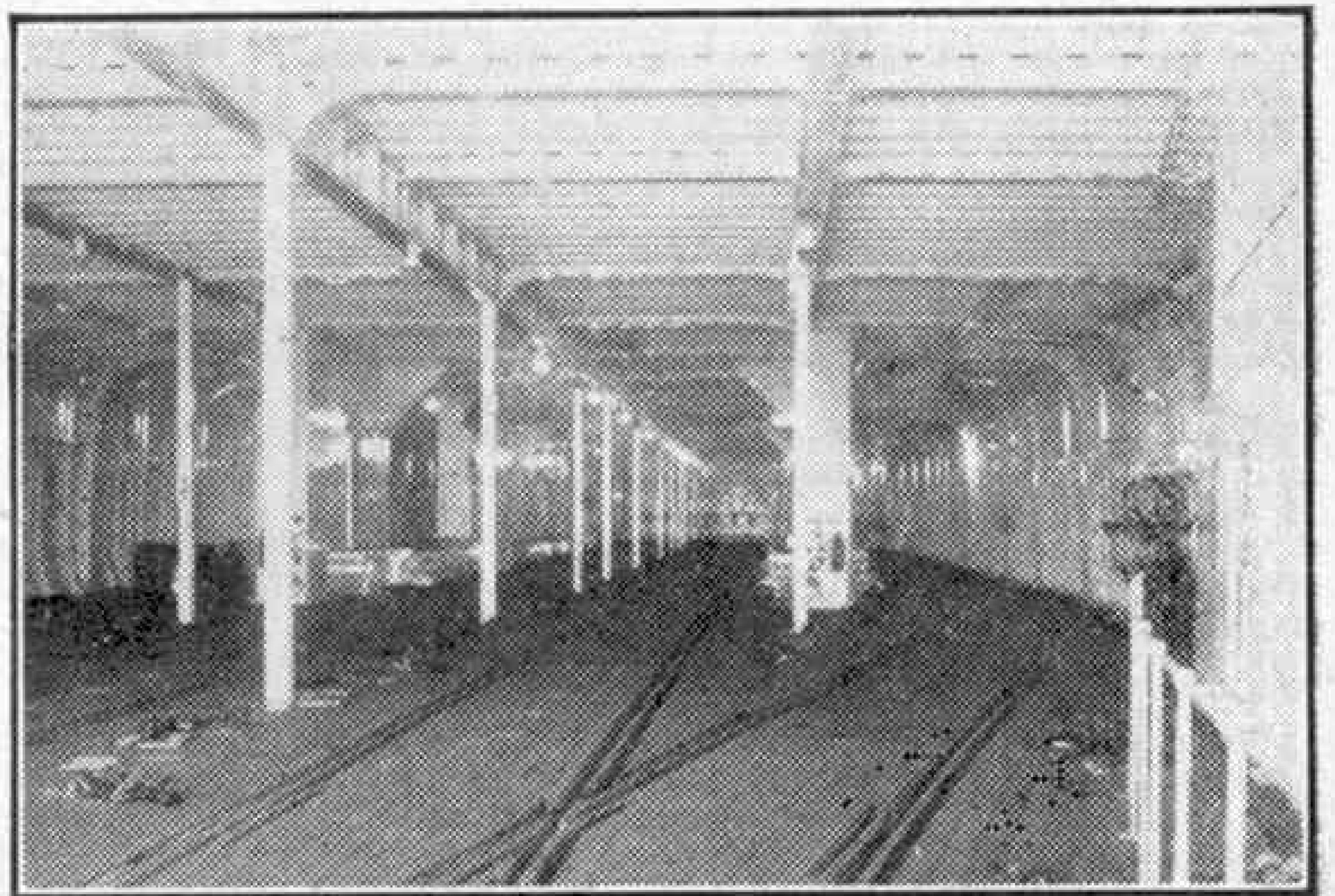

On the train deck of the "*Saint Germain*," showing its four tracks. At the head of the page is a general view of this cross-Channel diesel-engined vessel. Photographs by courtesy of S.N.C.F. (French Railways).

Air News

By John W. R. Taylor

"Neptunes" for the R.A.F.

Following several weeks of intensive flying and ground training at the Lockheed Company's airfield in California, U.S.A., Royal Air Force crews have flown to England the first of a batch of "Neptune" patrol bombers destined for Coastal Command's off-shore anti-submarine patrol squadrons. The "Neptunes" are of the latest P2V-5 type, with Wright compound engines, additional defensive armament, a large radome under their fuselage and special large wing-tip tanks containing radar equipment, a searchlight and fuel. Similar aircraft are being supplied to the U.S. Navy and the Royal Australian Air Force.

. . . . And "Skyraiders" for the Navy

Further evidence of the importance attached to anti-submarine defence is the delivery to Britain of an advance guard of four carrier-based Douglas "Skyraiders," which the Royal Navy will use side-by-side with its "Fireflies" until the Fairey "Gannet" comes into service.

These "Skyraiders" are of the type AD3-W, fitted with extensive radar search equipment, including a huge scanner under their fuselage. But Douglas have now produced a new AD-5 "Multiplex Skyraider," which can be transformed quickly from an anti-submarine search machine to either an attack plane with a four-ton warload of bombs, rockets and torpedoes, a photo-reconnaissance or target-towing aircraft, or even a passenger, freight or ambulance transport. They have achieved this by redesigning the airframe as a "universal chassis," to which any one of a wide variety of loads can be attached almost as easily as different-shaped trailers can be hooked on to a "mechanical horse" road vehicle.

Warning to Bandits

An "Auster" light aeroplane has been flown to Singapore for use in the jungle war against Communist bandits in Malaya. Its purpose is to fly low over the jungle and broadcast propaganda messages in local dialects to guerrilla bands, through loudspeakers in the rear of its cabin.

The "Auster" landed at Singapore minus its wings, having been dismantled in Britain and flown out inside a "Valetta" of R.A.F. Transport Command.

Prototype Costs

Some interesting figures concerning the cost of aircraft prototypes have been published in America. The wartime XP-38 "Lightning" cost £9 per lb. of its loaded weight, and the first XF-86 "Sabre" £82 a lb. The first "Superfortress" worked out at £21 a lb., whereas the new Boeing XB-52 will probably cost £90 a lb. and the next big experimental bomber after that as much as £140 a lb. As this bomber will weigh anything up to 150 tons it will thus represent

an investment of about £42 million.

Nor is equipment getting cheaper. The wartime Norden bomb-sight weighed 126 lb. and cost £1,800, whereas the K.1 optical and radar sight now in use weighs almost a ton and costs nearly £93,000 installed.

First India-Built Aeroplane

India's first home-produced aeroplane, the Hindustan HT-2 two-seat primary trainer, has completed its flight tests, and a production order for 300 has been placed. The prototype has a "Gipsy Major" engine, but later machines will be fitted with 158 h.p. "Cirrus Majors."

Born to be Beaten

One of the U.S.A.F.'s latest recruits was born just to have accidents happen to him. Known as an anthropomorphic dummy, he is not human but has many human characteristics. For instance, he has brittle collarbones, just like people, and his vinyl plastic foam skin shows the effect of cuts and grazes.

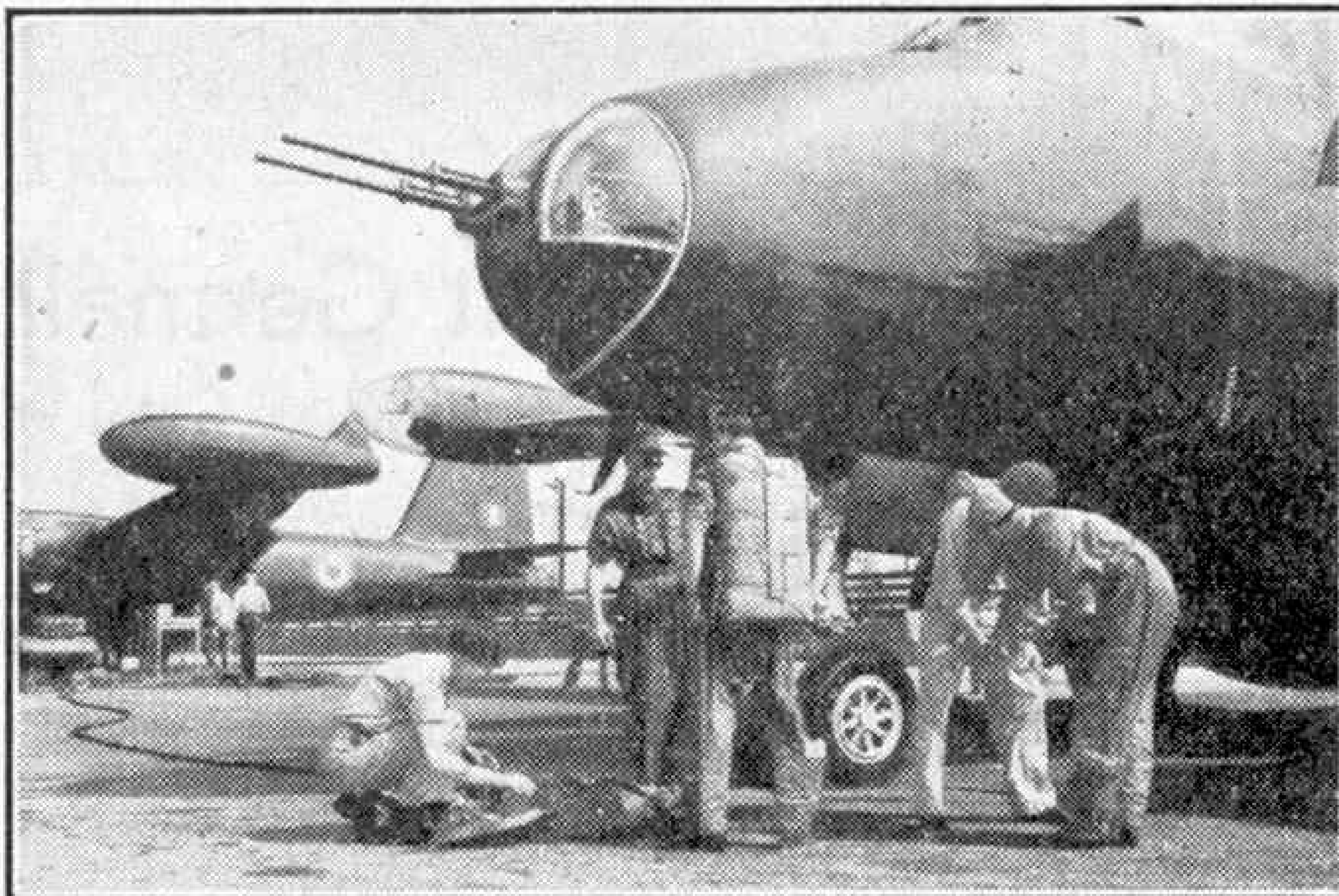

R.A.F. aircrews at Lockheed airfield preparing to fly latest type P2V-5 "Neptune" patrol bombers to England. Photograph by courtesy of Lockheed Aircraft Corporation, U.S.A.

In fact, he has been built to correspond to the measurements, weight distribution and anatomy of a 200-lb. man.

He reports for duty at Edwards Air Force Base, California, where he undergoes crash-impact, drop, acceleration and deceleration tests. His resultant "wounds" and broken bones show what would happen to a human pilot in similar circumstances, and are helping Aero-Medical Laboratory scientists to find ways of preventing such injuries to airmen.

Cross-Channel Cow Ferry

Following their achievement in ferrying more than 13,000 vehicles across the Channel in seven months last year, Silver City Airways have completed the task of flying 1,800 cows over the same route, from Lympne to Le Touquet. The cattle were on their way from Ireland to Italy, and were transported at the rate of 300 a week for six consecutive weeks. This involved one "Freighter" full of cows taking off for the Continent every 90 min. of the daylight hours.

The cattle flights were fitted in between normal cross-Channel car ferry services which, this year, are continuing throughout the winter. They bear testimony to the versatility of the Bristol "Freighter," which can literally carry two Rolls-Royce motor cars on one flight and eight cows in special stalls on the next journey.

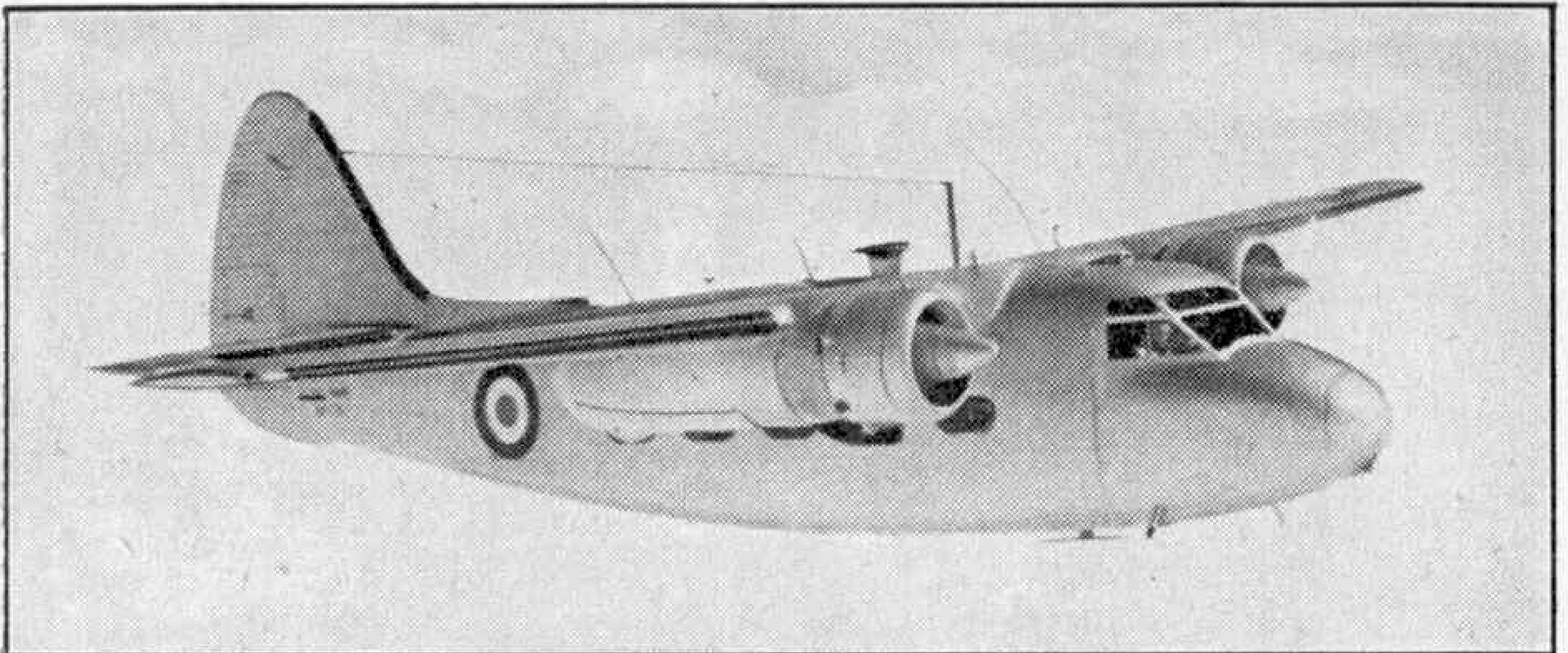

Percival "Sea Prince," a Royal Naval Communications aircraft. The "Prince" light transport has been adopted by the R.A.F., in which it will be known as the "Pembroke." Photograph by courtesy of Percival Aircraft Ltd.

Princely Progress

Following the lead of the Royal Navy, the Royal Air Force have ordered a number of Percival "Prince" twin-engined light transports for communications, freighting, long range ferrying and air ambulance duties. They will be known as "Pembrokes."

The unrestricted cabin interior of the "Pembroke" permits rapid switches from one duty to another. There are permanent fittings for each, so that the aircraft's eight rearward-facing passenger seats, or stretchers for casualty evacuation, can be removed quickly and the entire cabin floor cleared for carrying freight lashed to built-in strong points. The main cabin door is removable, so that cargo can be thrown out by parachute during flight, if necessary; and full oxygen, de-icing and night-flying equipment is fitted.

Airstops for Helicopters

The Ministry of Civil Aviation have announced that helicopter passenger stations are to be known officially as "Airstops." The similarity to "bus stop" is intentional, as helicopters will be the air 'buses

of the future, landing in the centres of cities and towns all over the country, in contrast to air liners, which can use only a few large, widely separated airports.

The name "Airstop" was chosen from a list of more than 70 suggestions, ranging from "Updown" to "Rotorpodio;" but B.E.A. say that *they* still intend to use the name "rotor-station."

A New "Banshee"

The new McDonnell F2H-2P "Banshee," illustrated at the foot of this page, is the first U.S. Naval jet fighter produced for photographic-reconnaissance missions. Six different types of camera can be fitted behind windows in its lengthened nose, and the pilot has a special view finder that gives him a clear, unobstructed view of the ground below and ahead of the aircraft.

Based on the well-known F2H-2 "Banshee," the new machine has a speed of more than 600 m.p.h., and has already completed successful photographic missions at heights ranging from 50 ft. to ten miles.

Real Flying Saucers

The U.S. Army have admitted that they are experimenting with flying saucers, but not the sort that we all read about several months ago. These saucers are disc-shaped containers, made of synthetic rubber and holding five gallons of water, petrol or other liquid. Tests have shown that they can be thrown out of aircraft to troops on the ground, at high speeds and from considerable heights without bursting. On hitting the ground they simply spread out to almost double their normal size, bounce back into the air and then drop back near their original point of impact.

R.A.F.'s Big Transport Job

During the first three weeks of recent Middle East air trooping operations, aircraft of Transport Command and the Middle East Air Force transport wing carried 10,000 soldiers and 350 vehicles and guns to the Canal Zone. In addition they had to fly in all supplies needed by the British forces.

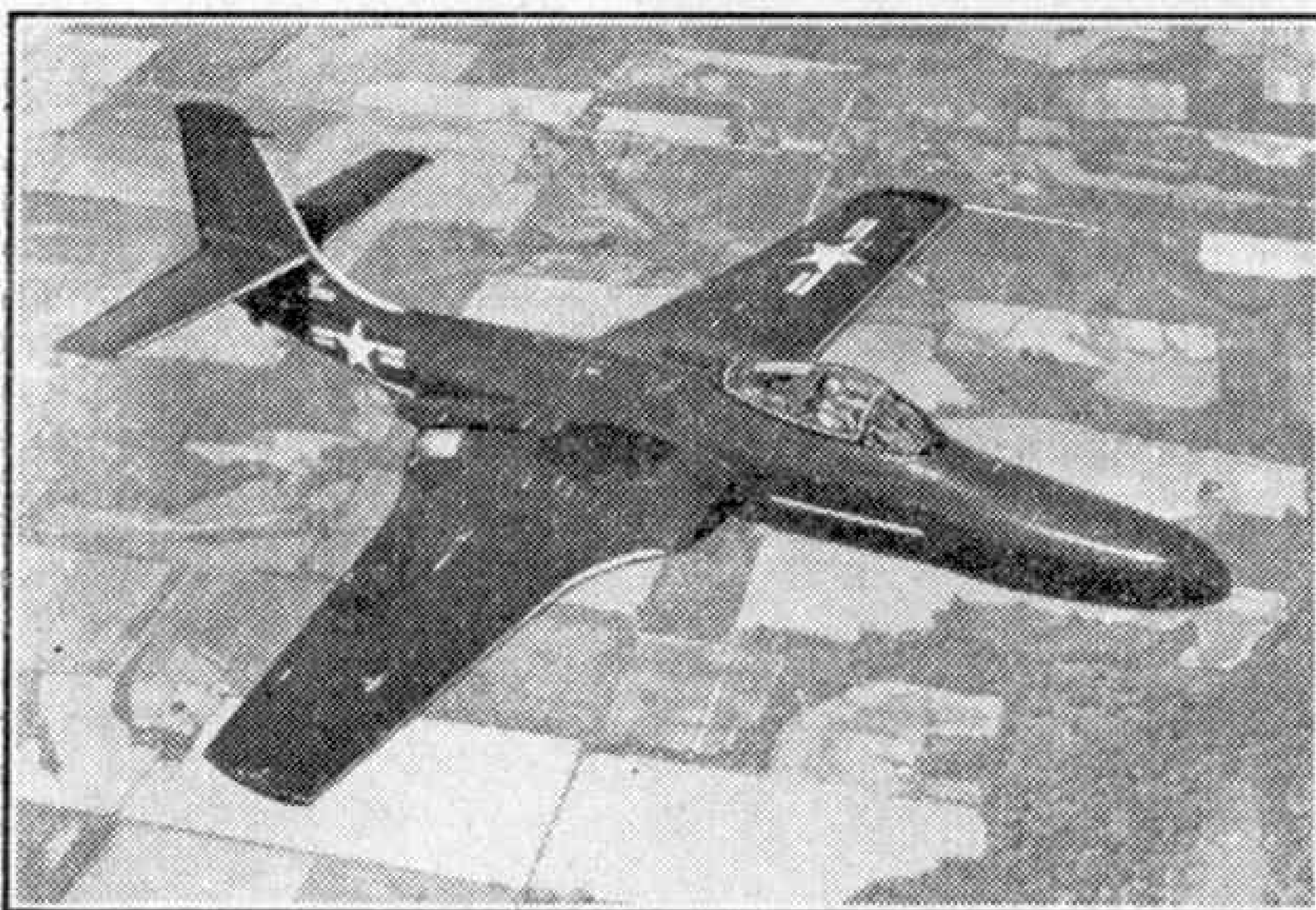

Latest version of the McDonnell "Banshee," the first U.S. Naval jet fighter for photographic-reconnaissance duties. Photograph by courtesy of McDonnell Aircraft Corporation, U.S.A.

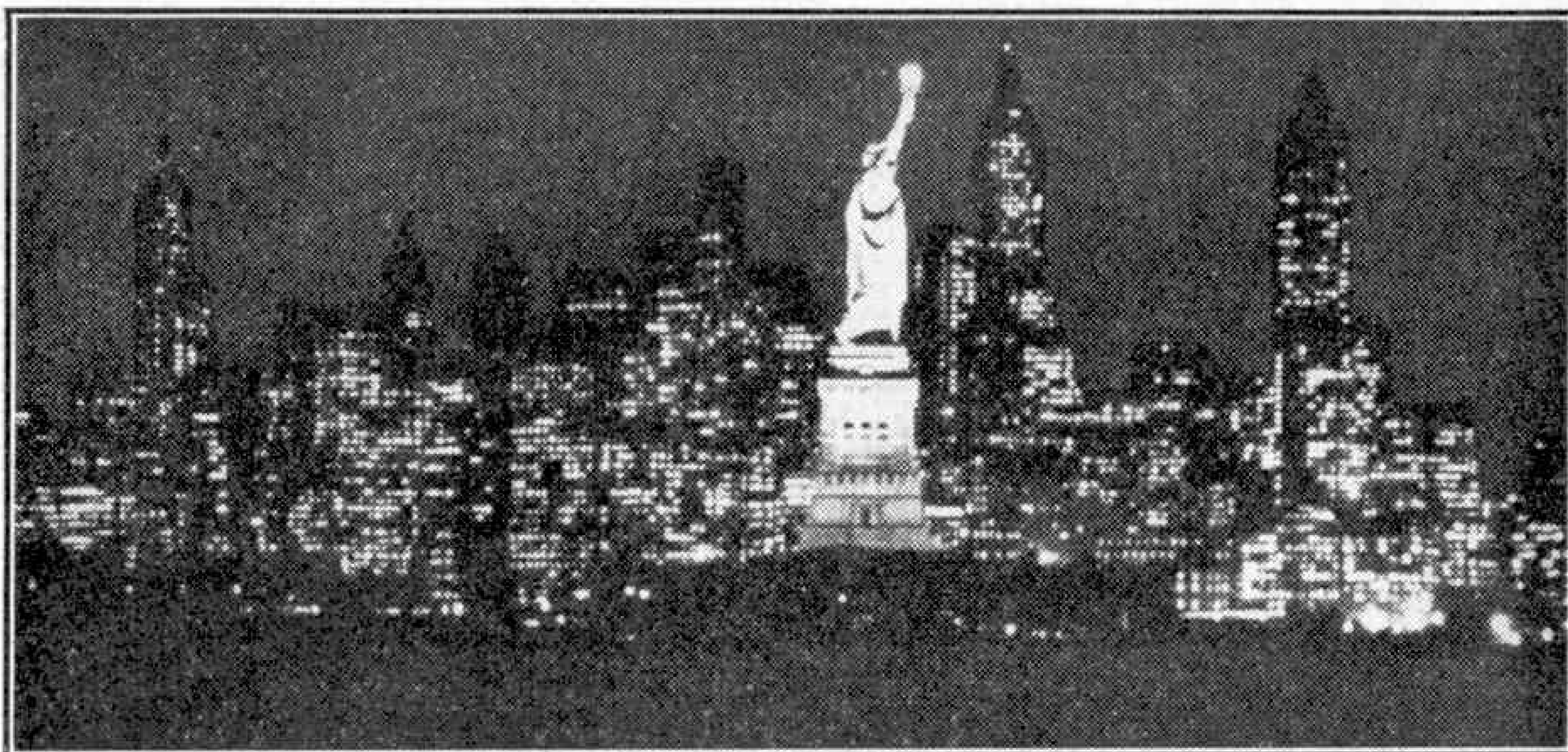

The World's Tallest Statue

By Arthur Nettleton

FOR more than 65 years the approach to New York harbour has had as its sentinel the tallest figure in the world. It was on 28th October 1886 that the huge Statue of Liberty, holding a torch 305 ft. above the sea, was formally dedicated by President Cleveland. Since that time it has gained world-wide recognition as the symbol of freedom, and homeward-bound Americans, as well as visitors from other lands and immigrants arriving to make new homes in the United States, have been thrilled by the colossus greeting them. Yet the story of this monument is far from widely-known, and few beholders are aware of all the interesting points about it.

The idea of erecting such a figure first arose in 1873, when Frederic Auguste Bartholdi, the famous French sculptor, envisaged it as one of the Seven Wonders of the modern world. Tradition says that his original aim was to present it to Britain, and that it was intended to be set up at the Port Said entrance to the Suez Canal, but the canal authorities failed to give an assurance that they would provide

a suitable pedestal. The proposal was then put before the American people, who accepted it as a symbol of friendship between France and the U.S.A. Americans did indeed pay for the ornate base, while the people of France subscribed for the statue itself.

Festivities of various kinds were held to raise the necessary funds, and the original plan was to have the complete monument ready for dedication on the 100th anniversary of American independence, in 1876. Not until a year later, however, did the American Congress pass the necessary Act accepting the gift, and the building of the pedestal was not begun until 1883.

Meanwhile, the creation of the statue was proceeding in

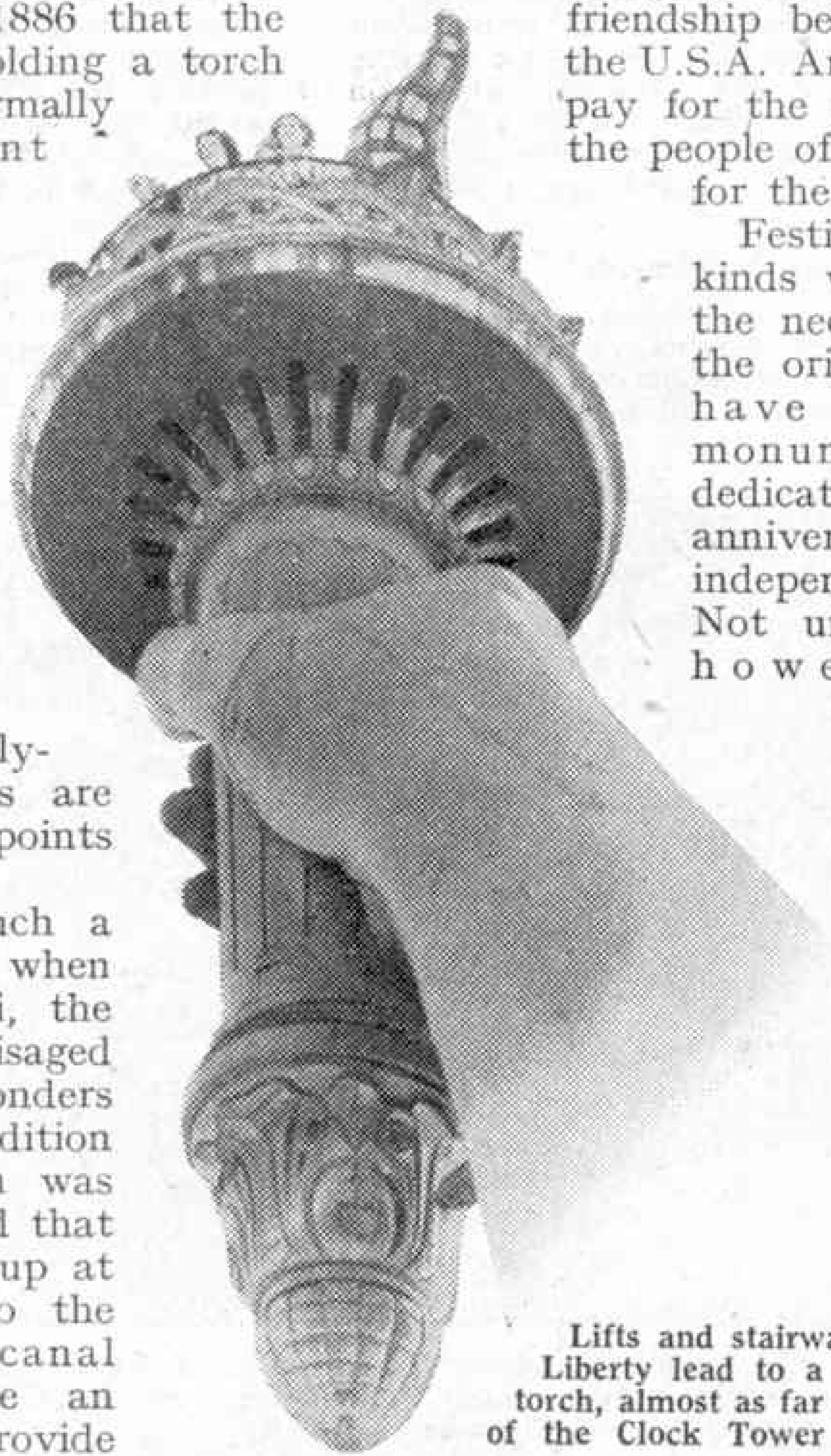

Lifts and stairways within the Statue of Liberty lead to a gallery on the gigantic torch, almost as far above ground as the top of the Clock Tower that houses Big Ben.

slow stages in France. Making such a gigantic figure was an engineering job of great magnitude, entailing careful preliminaries. The first step was to prepare a studio model 7 ft. high, and it is said that M. Bartholdi's mother was enlisted to sit for this piece of sculpture.

The stresses and strains to which the final statue would be subjected also had to be investigated, and the strength of the site on which it was to stand in America tested. It was realised that such a tall structure might be affected by the Atlantic gales, and that strong foundations would be essential.

A curiosity about work on the actual statue is that it was made from the top downwards, the hand bearing the torch being the first part to be constructed. This section, in fact, was ready in 1876, and was taken to the U.S.A. for the Centennial Exhibition held in Philadelphia in that year.

The figure is a copper shell, fashioned on plaster moulds and braced inside with an intricate network of iron bars and girders. It was made in no fewer than 350 separate parts, some of them entailing as many as 9,000 measurements to enable the details of the model to be properly enlarged.

Gustave Eiffel, the creator of the Eiffel Tower, helped in this engineering work, and he also designed a massive iron frame in Paris, inside which the statue was built, to test whether the parts fitted accurately before they were shipped to America.

Erecting this amazing monument on Bedloe's Island, New York, was a stupendous feat. Work in strong winds at considerable elevation was risky and tedious, and the small area of the site limited the number of men who could be employed at any one time. The statue had been brought across the Atlantic in the French warship "*Isero*," and each section had been packed in a wooden frame to prevent bending in transit. The parts, still in their frames, were hoisted to a wooden platform on the pedestal that awaited them, and the frames were not removed until the tackle for lifting the sections to their proper positions was securely fixed.

Thanks to these precautions, the parts fitted perfectly, and one of the marvels of the Statue of Liberty is that it shows no unsightly lines where the sections are joined. Warping of the thin copper shell has been prevented entirely by building the figure in such a way that no parts of the interior iron struts are in

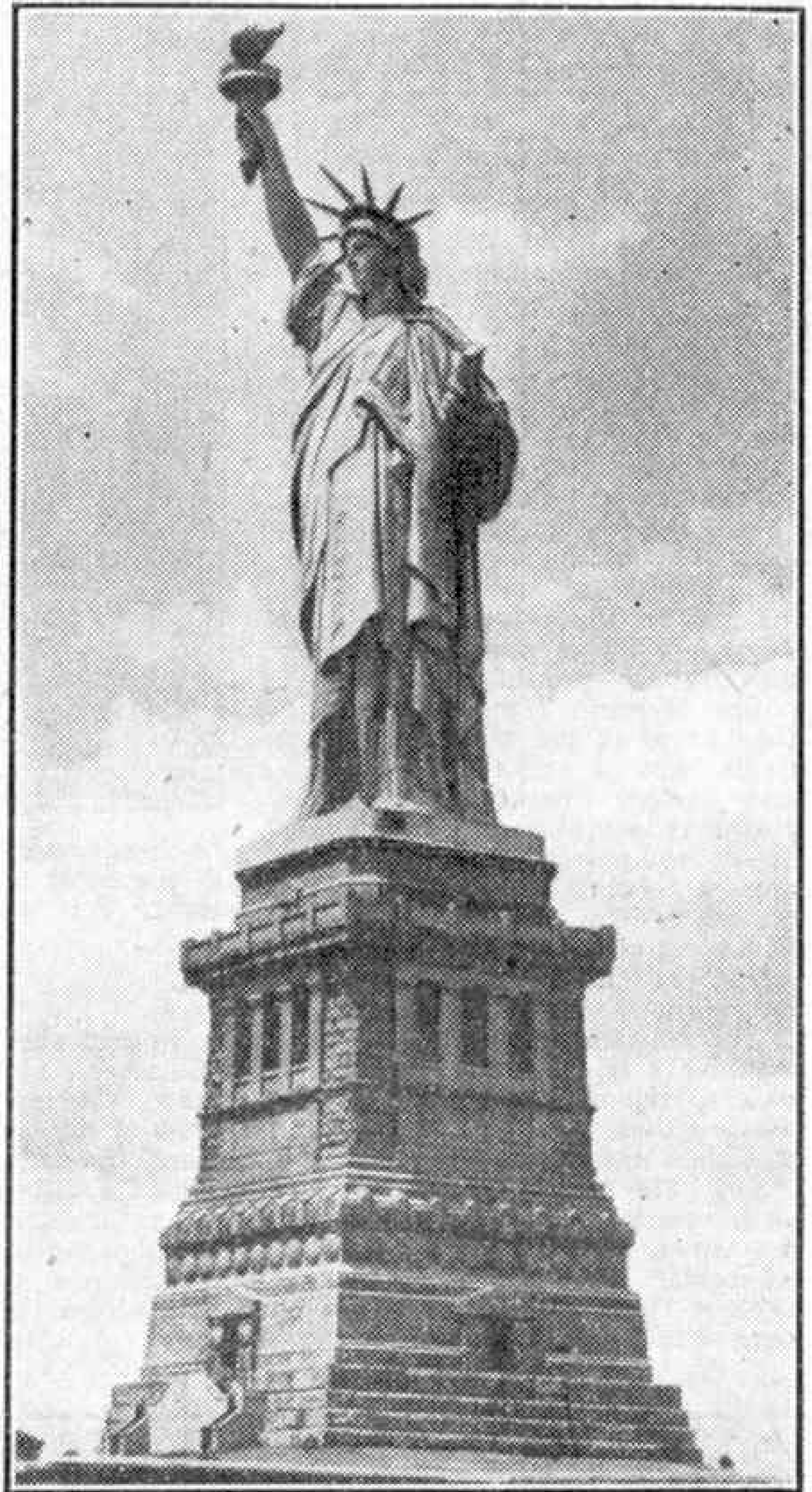

The base of the statue is 90 ft. high, and a gallery round it gives extensive views of the Hudson River front of New York. At the head of the opposite page the floodlit statue is seen against the background of the city skyscraper lights.

direct contact with the copper. A covering of shellac and the insertion of strips of asbestos are further safeguards against damage; these help to prevent corrosion by the damp salt air.

To-day the powerful electric light in the torch is kept on from dusk till dawn. This is done mainly for effect, but until 1902 the light was maintained as a guide to shipping, and was the concern of the U.S. Lighthouse Board. The tiara on the head of the figure also is illuminated.

The entire monument weighs over 100 tons, and some idea of its size may be gained by comparing it with the Clock Tower of the Houses of Parliament, London. It is only 9 ft. less in height than that London landmark, and indeed it is half as high (Continued on page 94)

Of General Interest

Underwater Television

The underwater television camera with which the lost submarine "Affray" was examined could "see" a distance of 15 ft., which was three times as far as the range of vision of the divers who had previously examined the vessel. It had the further great advantage that it could work continuously for two hours or more when lowered to the required depth of 280 ft., where a diver could work for only a few minutes at a time.

The Marconi "Image Orthicon" tube fitted in the camera required to be kept at one temperature to give correct operation. For this reason it was necessary to include in the equipment a camera heater and a cooling fan, both with remote control. There was also a device for showing the temperature inside the camera, with a remote level indicator and a water leak detector.

The container for the camera was a welded steel cylinder 2 ft. long and 1 ft. 5 in. in diameter. The base of the cylinder supported the camera, the lens window, which was made of plate glass $\frac{3}{8}$ in. in thickness and with a diameter of 3 in., and the cable gland. The cable used was of the 32-core type, fitted with protective sheathing. Underwater lighting was given by a diver's lamp, which was mounted on a special tubular framework that also helped to protect the camera container. Shields prevented the light of the lamp from reaching the camera lens directly.

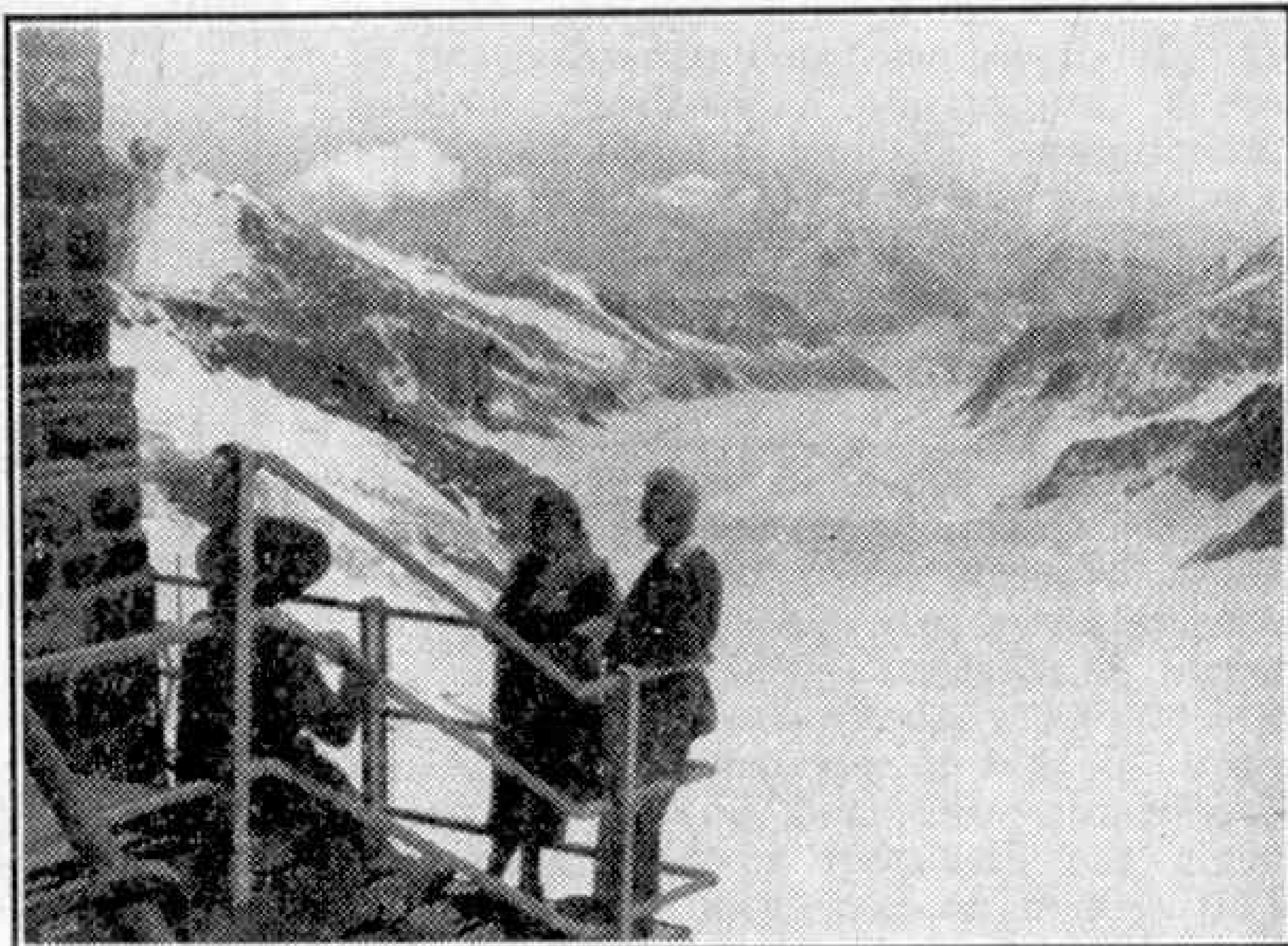

Looking out over the Aletsch Glacier, the largest in Europe, from the hotel at the upper terminus of the Jungfrauoch Railway, 11,340 ft. above sea level. This Swiss mountain railway will be described and illustrated in an early issue of the "M.M."

The container in its framework was hung lens downwards by means of a non-spin wire from a derrick of H.M.S. "Reclaim," the Admiralty diving ship. The underwater scene was viewed on the screen of an ordinary television receiver that had been fitted to receive signals direct from the cable line.

Tricks with Migrating Starlings

Have birds a mysterious sixth sense that guides them in their migrations, as many have supposed? Trials with starlings made recently by Dr. G. Kramer suggest that in fact they find their direction by means of the Sun.

Dr. Kramer's starlings were kept in a circular cage, 2 ft. in diameter, that could be turned round at will. When the urge to migrate came on the starlings invariably flew towards the south west, the direction followed in migration by most birds from north-west Germany, the scene of the experiments. They did this only when they could see the Sun itself, or a part of the sky not too far away from it. When distant portions of the sky only were visible the birds seemed to have no sense of direction, and this was the case also when the sky was so clouded over that the Sun could not be seen.

Dr. Kramer then deceived the birds by giving them an artificial Sun to look at. This was an electric light bulb, which could be made to rise at any compass point. Most of the birds then flew in the direction that on this basis would be south west to them. For instance, if the "Sun" rose in the north instead of the east they flew south-east instead of south-west.

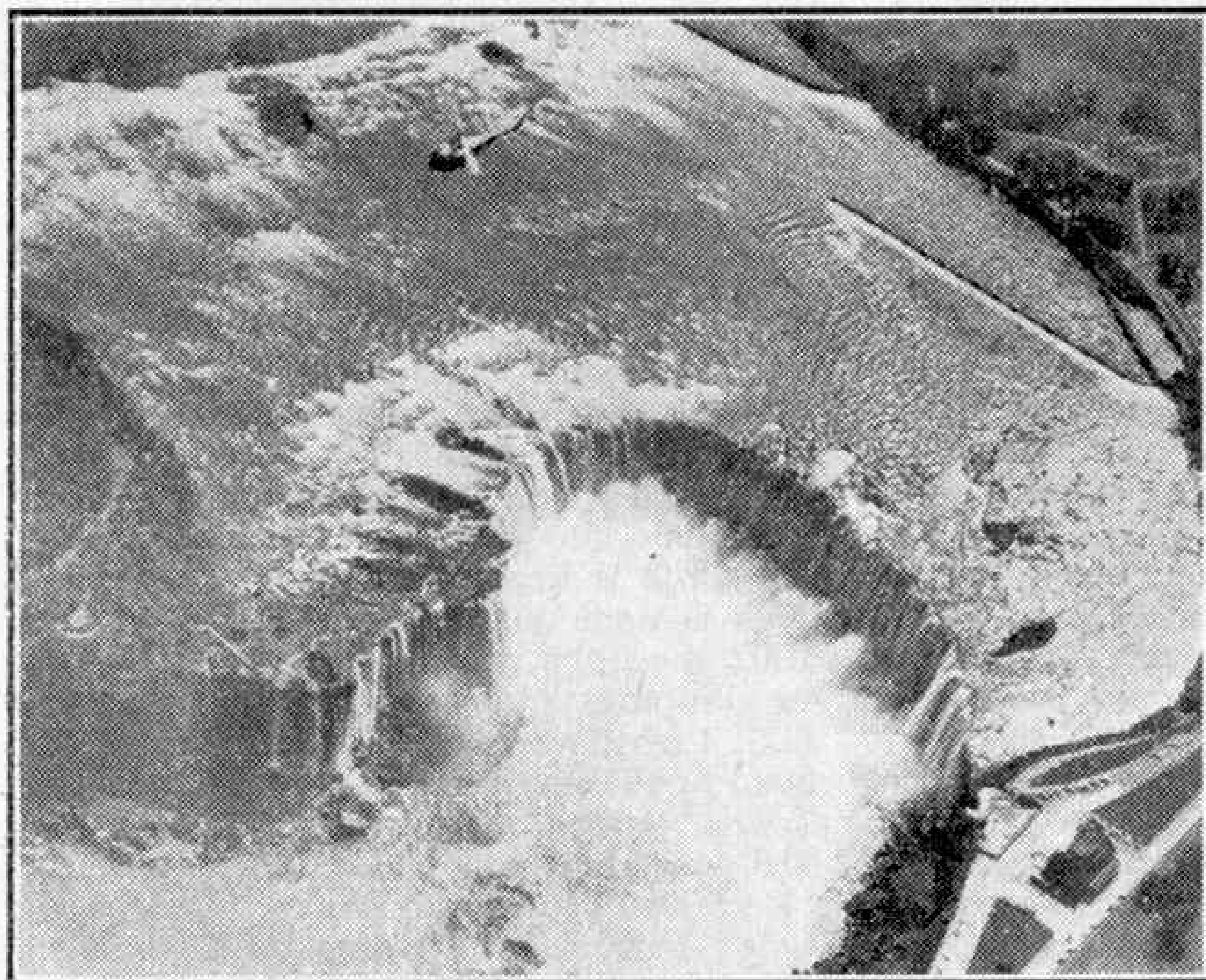

The Horseshoe Fall at Niagara, photographed from the air. A helicopter can be seen flying over the cataract.

Simple Bird Photography

By E. E. Steele

ALTHOUGH bird photography on an ambitious scale is usually practised by the expert, making use of telephoto lenses and a "hide" in which the photographer is able to watch and take pictures without being observed by the bird, much can be done in a garden with the simplest equipment.

During the Winter and early Spring birds are very easily attracted to the garden by keeping up a regular

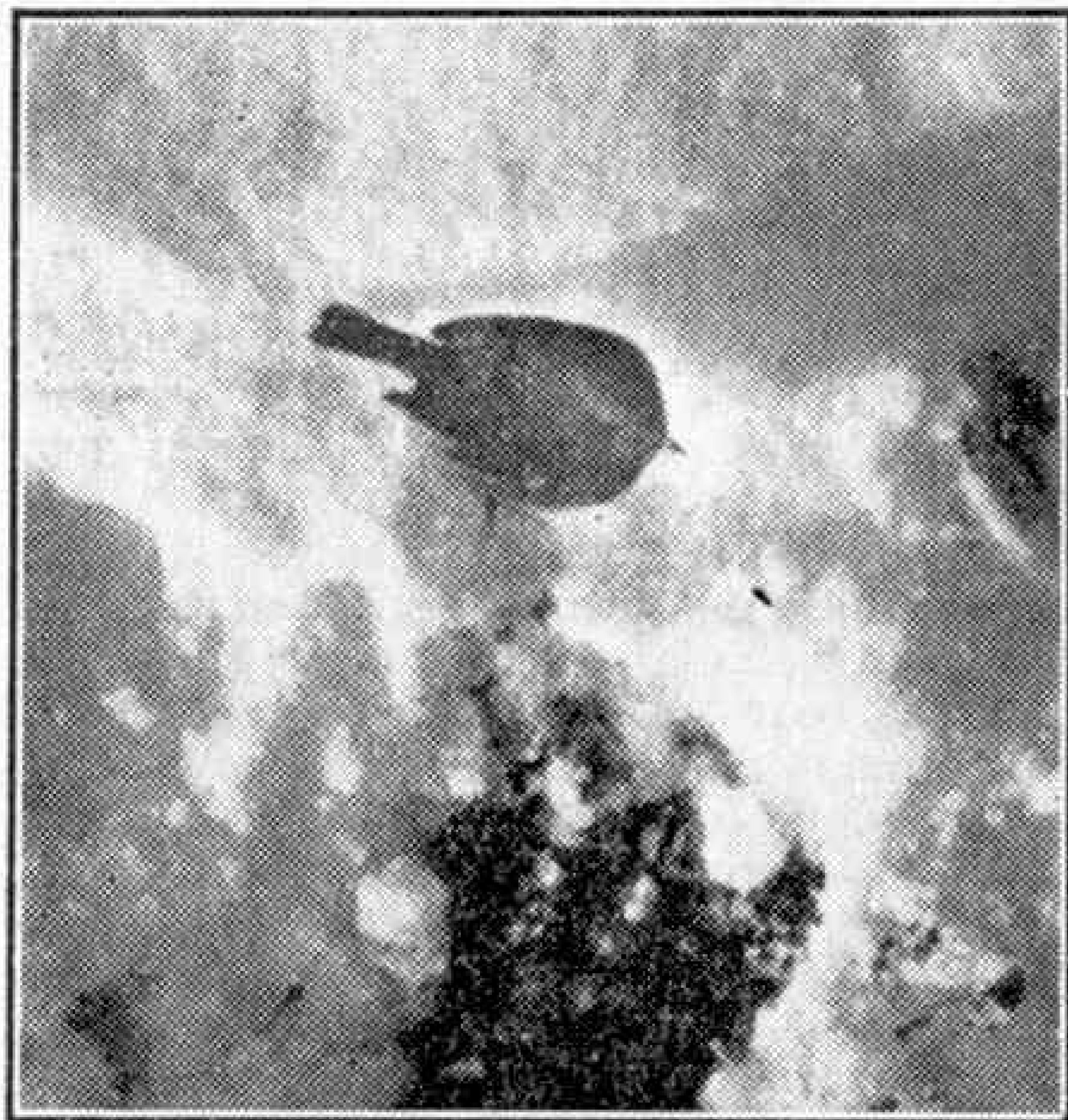

Snow makes robin bold.

food supply for them. This is best done by constructing a simple bird table, which need consist of little more than a pole firmly fixed in the soil with a piece of board secured to the top to form a platform on which to place the food, which may consist of any household scraps. Birds will come more readily to such a table if there are a few adjacent bushes to act as cover. The birds fly to these, take a wary look round, and then fly straight to the table. This should be high enough to discourage flying leaps by cats who also show considerable interest in bird tables!

My bird table is arranged exactly 3 ft. from the window of a garden shed, the reason being that my camera will focus down to a distance of 3 ft., and I can get the bird as large as possible on the negative without a telephoto lens. Ordinary birds of the garden seem tame enough to allow working at this distance, provided the camera and photographer are invisible, although the sight of the



The starling is suspicious. The illustrations to this article are by the author.

lens sticking through a hole doesn't seem to worry them.

In practice a section of the window is removed, to be replaced by a wooden shutter with an aperture cut out so that the lens of the camera protrudes through. There is no glass in the way between camera and subject, which would be very undesirable. The camera is focused to 3 ft., and one waits a little time for the first bird to spot the scraps previously placed on the table. Soon there is a flurry of wings, and various birds, such as sparrows, blue-tits, starlings, and maybe a robin visit the table. By the way, the camera is arranged to be just a little higher than the table, making the most suitable position.

Although one will seldom obtain the rarer birds by such methods, the common ones are just as interesting, especially the blue-tits, whose antics are most entertaining. When snow is on the ground a handful of crumbs will often bring a robin near enough to be photographed out-of-doors, for such conditions make birds very tame. Panchromatic film gives the best rendering of the robin's red breast.



The greedy sparrow takes a large helping.

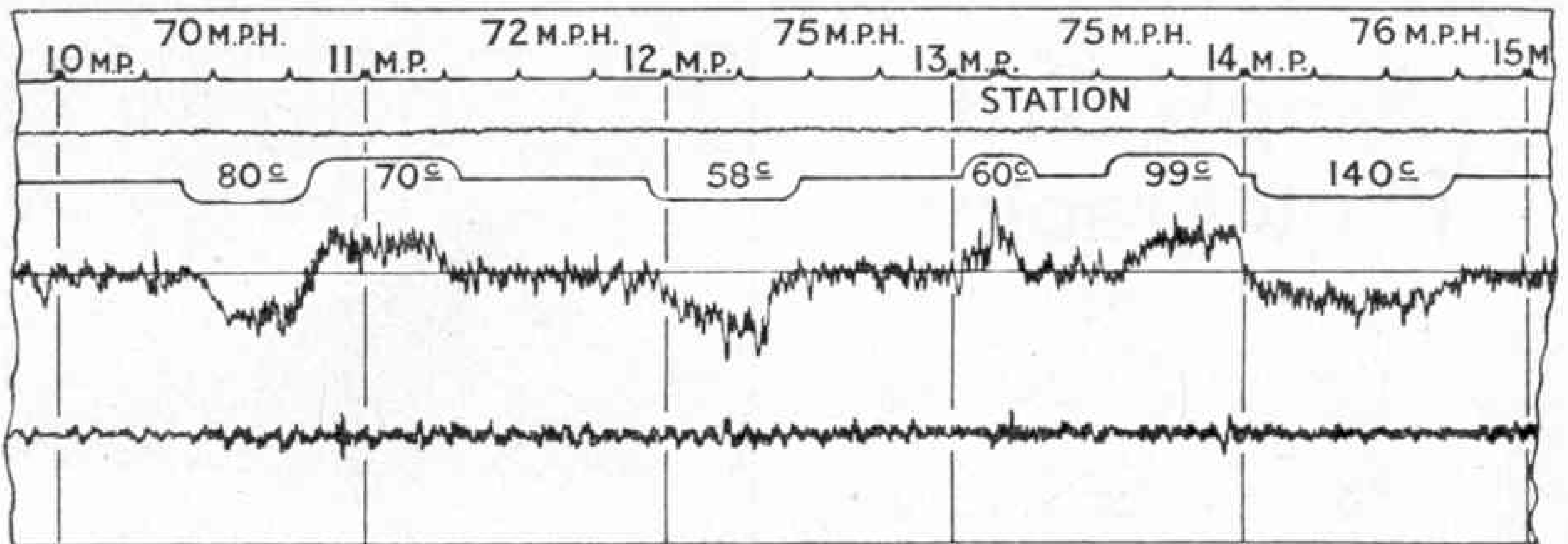

A section of the chart from a Hallade Track Recording Machine showing the markings referred to in this article.

The Hallade Track Recorder

By D. Stewart Currie, G.I.Mech.E., G.I.Loco.E.

THE Hallade Track Recorder is an instrument of French design which was introduced into this country by the former Great Northern Railway. It is used by the Civil Engineer's Department of the railway, and its function is to produce a graphic record of the defects in the alignment, top, and superelevation of a track over which it is carried in a train.

The apparatus is portable, and is usually carried in an ordinary passenger compartment immediately over the bogies of a fast non-stopping train. An exception to this is found on the Western Region, where the machine is mounted in the "Whitewash Coach" which was described in the October 1950 issue of the "M.M." By means of three systems of pendulums, which are connected to pens, there is inscribed on a moving paper roll a continuous record of the oscillations of the coach during the journey. From the chart thus obtained, any defects can be located. The machine is driven by a clockwork motor which is governed to run at a constant speed, thus feeding the paper under the pens at a uniform rate; this is usually one millimetre per second.

On the chart itself, a section of which is reproduced at the head of this page, the first line is produced by a pen under the control of an operator leaning out of the carriage window. This is the line that runs along the chart under the series of markings "10 M.P.," "11 M.P." and so on. The duty of this operator is to note all mileposts, quarter-mileposts, stations, water troughs and tunnels; by depressing a bulb which is connected to the machine by a tube he can mark their positions on

the chart. One mark indicates a quarter-milepost, two indicate a milepost and three give the position of a station. As the rate at which the paper travels through the machine is known, the speed of the train can be calculated by measuring the distance between the marks on the chart. The direction of the run is always from left to right on the chart, so that in the extract shown, the train is travelling from milepost 10 to milepost 15. Also, the faster the train goes, the shorter will be the distance between mileposts on the graph.

The second line on the chart is produced by the action of the first pendulum system. It indicates acceleration and braking, also any rolling of the coach. If the line tends to fall below its normal level, the train is slowing down; when it rises above the mean level the train is gathering speed rapidly. If, however, the pen swings up and down, the coach is rolling. There is very little indication of this on the chart shown.

Line number three is added to the chart in the office after the run has been completed. It indicates if the track is straight or curved, and if curved, its direction. That is, a left hand curve is one where the track bears away to the left when looking in the direction of travel. The first curve on the chart, "80c" signifying 80 chains radius, is an example of a left hand curve, while the second curve, of 70 chains radius, is right handed.

A fourth line is made by a pen attached to the second pendulum and records transverse or sideways movements. Among

the defects revealed by this line are poor alignment, poor transitional curves when entering or leaving a main curve, irregularities in the curves, and incorrect cant or superelevation. If a train goes round a curve at the speed for which that curve was canted, then the pen line should follow the centre base line. In the chart shown, however, the train has been travelling at a speed greater than that for which the curve was canted, and in such conditions the pendulum tends to swing outwards due to centrifugal force. It can be clearly seen that the line of this curve closely follows the line which was added in the office to show the position of each curve. If, on the other hand, the train had been travelling slowly, the line traced by the pen would have appeared on the other side of the base line at each of the curves.

The bottom line on the chart is produced by the third pendulum and indicates vertical movement, that is the up and down movement of the coach. This is caused by low or high rail joints, sleepers that are not firmly packed, or by sharp changes in gradient.

The Hallade Records obtained from the machine are first examined by the technical staff of the Civil Engineer's Department, who note the position of any defects and the probable causes.

A list of these defects and a copy of the record are then sent to the Permanent Way Inspector in charge of that section of track, and it is his duty to locate the faults and give them attention.

On the most important lines, records are taken twice yearly and on the other lines once yearly. Thus by comparing a new record with previous ones taken on the same route, it is possible to see whether defects are being dealt with successfully and if improvement in running is being obtained. The use made of the Hallade instrument by the railways is not widely known by the general public, but it is just one example of how a check is kept on tracks up and down the country, thus helping to ensure that the high standard of safety set by the railway is maintained.

Passing now to the means by which the Hallade records are translated into actual maintenance operations, a good deal of attention is being given at the present time to permanent way work in order to speed up the job, reduce costs and to save manpower. Mechanisation has been applied to an increasing extent during

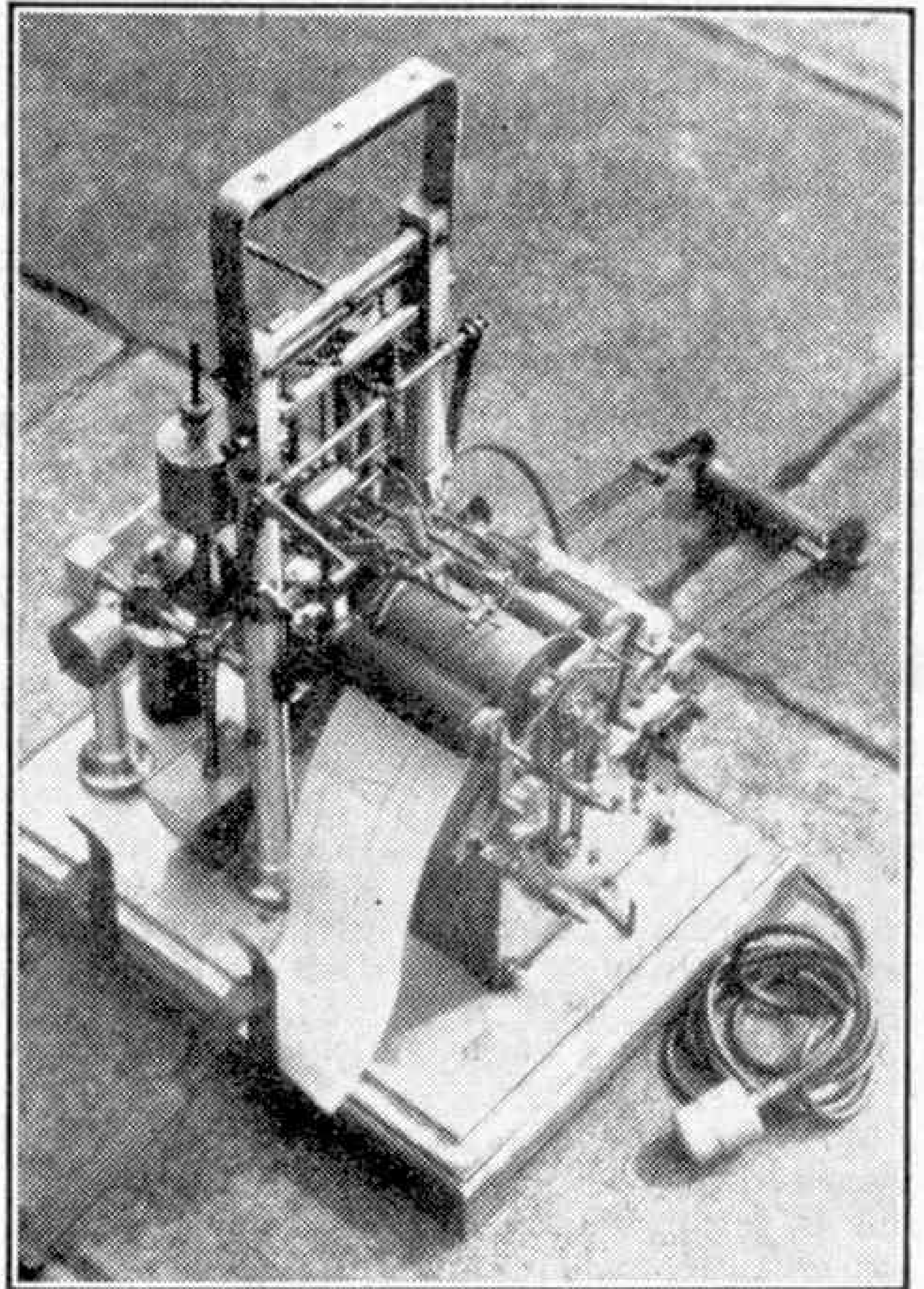

The Hallade Recorder itself showing the roll of paper on which the chart is drawn, and the pens that mark its lines. The pendulums are behind the main columns.

recent years and greater use is to be made by British Railways of power-driven tamping machines for consolidating the ballast under the sleepers. Other mechanical aids include machines for removing, cleaning and replacing the ballast, and for tightening screws, drilling and adjusting rails and even trimming hedges and mowing the grass on slopes. Some of these have been developed only recently and they have not by any means completely replaced the traditional hand tools and manual methods.

In the ordinary way each permanent way gang of from four to twelve men is solely responsible for the maintenance of a given section of the line, but an experimental "flying squad" system of maintenance is to be tried in four areas of British Railways. In these the normal gangs will be re-organised into a number of small groups and a few large gangs. The small groups will attend to the day-to-day maintenance jobs on their stretch of line in the ordinary way. The large gangs will be mobile, and fully equipped with mechanical appliances.

Among the Model-Builders

By "Spanner"

A Mechanical Man Built in India

Two of the accompanying illustrations show a remarkable mechanical man constructed mainly from Meccano parts by an Indian reader, N. Kameswara Rao, Rajahmundry, S. India. At the time the photographs reproduced here were taken, the legs of the model had still to be fitted.

An interesting point is that, apart from the driving Motors, the model can be built from a No. 10 Outfit. The man is approximately 5 ft. in height when complete with legs and is capable of moving his eyes, opening and closing his mouth and turning his head to right or left. He also salutes with his right hand, and if anyone hits him on the chest he will retaliate with a smashing left!

Most of the operating mechanism is housed in the head and chest of the model, and is set in motion by one Clockwork and one Electric Motor.

Many robots or mechanical men have been built in Meccano in the past, but it is always interesting to learn of new ventures, and I think that the model shown here is particularly noteworthy for its realistic appearance. If its movements are equally successful it must be one of the most attractive models of its kind that has so far come to my notice.

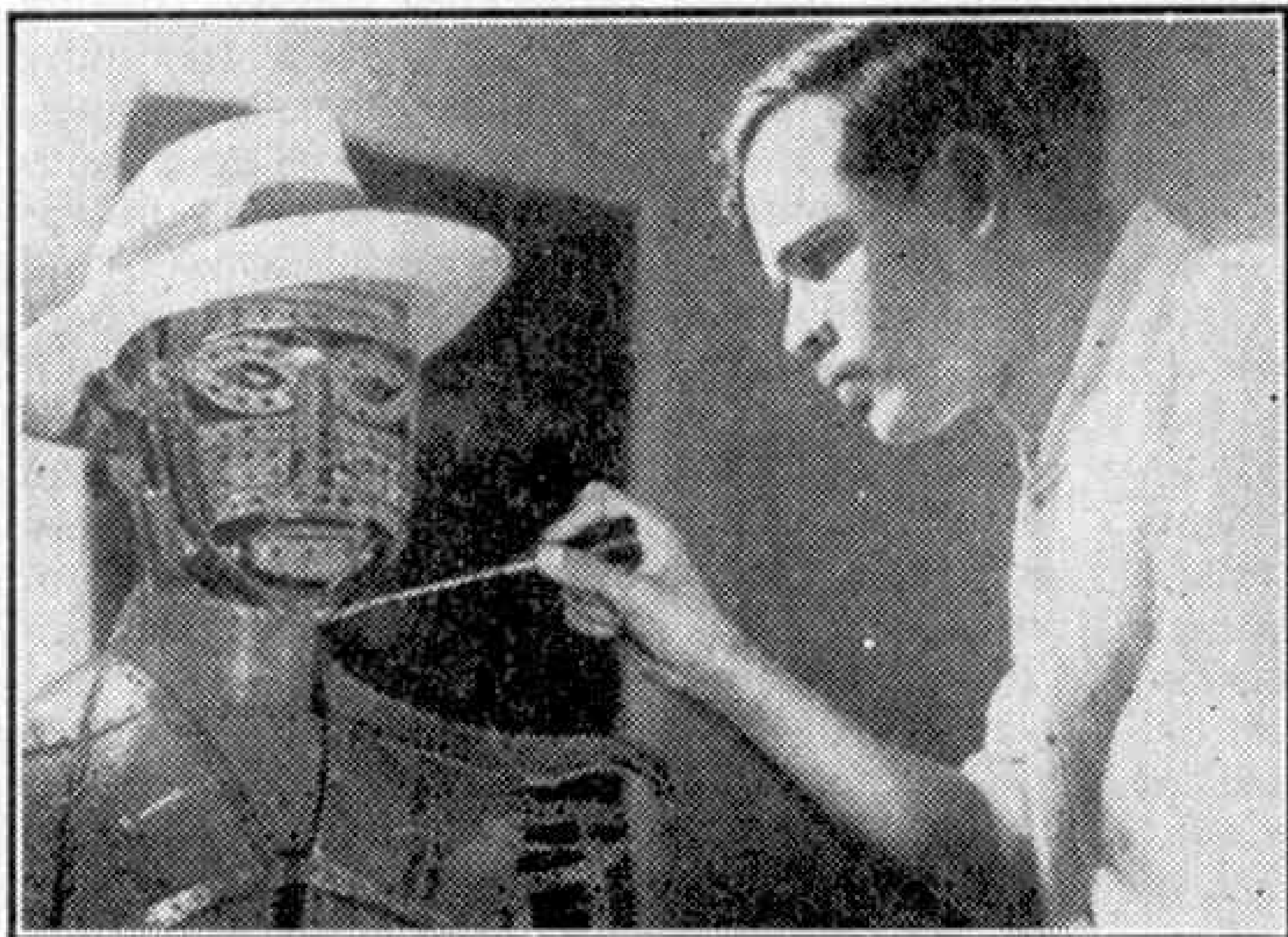

Fig. 1. N. Kameswara Rao, Rajahmundry, S. India, at work on his mechanical man.

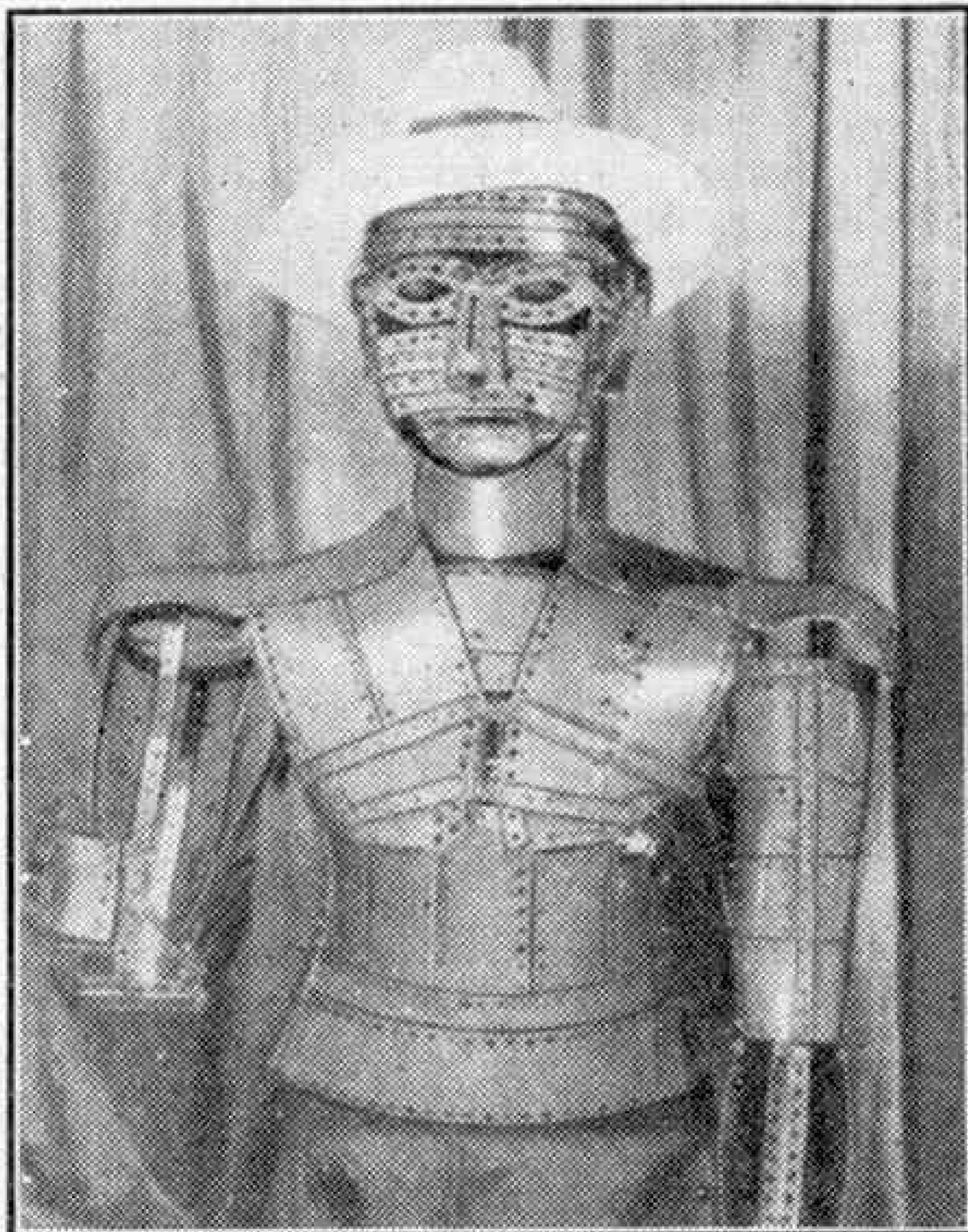

Fig. 2. The mechanical man before the legs were fitted. Inside the head and chest of the model is a mass of complicated operating mechanism powered by two Motors.

Automatic Brake for Crane Winding Shafts

D. W. Tyler, Waltham Cross, built a large model derrick crane recently and during its construction he devised a neat brake that is applied automatically to each winding shaft as soon as the motor drive is disengaged. The automatic mechanism is shown in Fig. 5 and I think model-builders will find the idea useful not only in cranes, but also in other models fitted with winding shafts.

The drive from the operating Motor is taken by Sprocket Chain to a Sprocket Wheel fixed on a Rod 1. A $\frac{1}{2}$ " diameter, $\frac{3}{4}$ " face Pinion on this Rod engages a 57-tooth Gear on a Rod 2, which is free to slide about $\frac{1}{4}$ " in its bearings. Another 57-tooth Gear 3 is mounted freely on Rod 2, but is prevented from sliding along the Rod by Collars. A Threaded Pin fixed to Gear 3 engages a hole in one of the side-plates of the mechanism and prevents the Gear from turning.

The winding shafts are formed by Rods 4 and 5, each of which is fitted with a 1" Gear and a

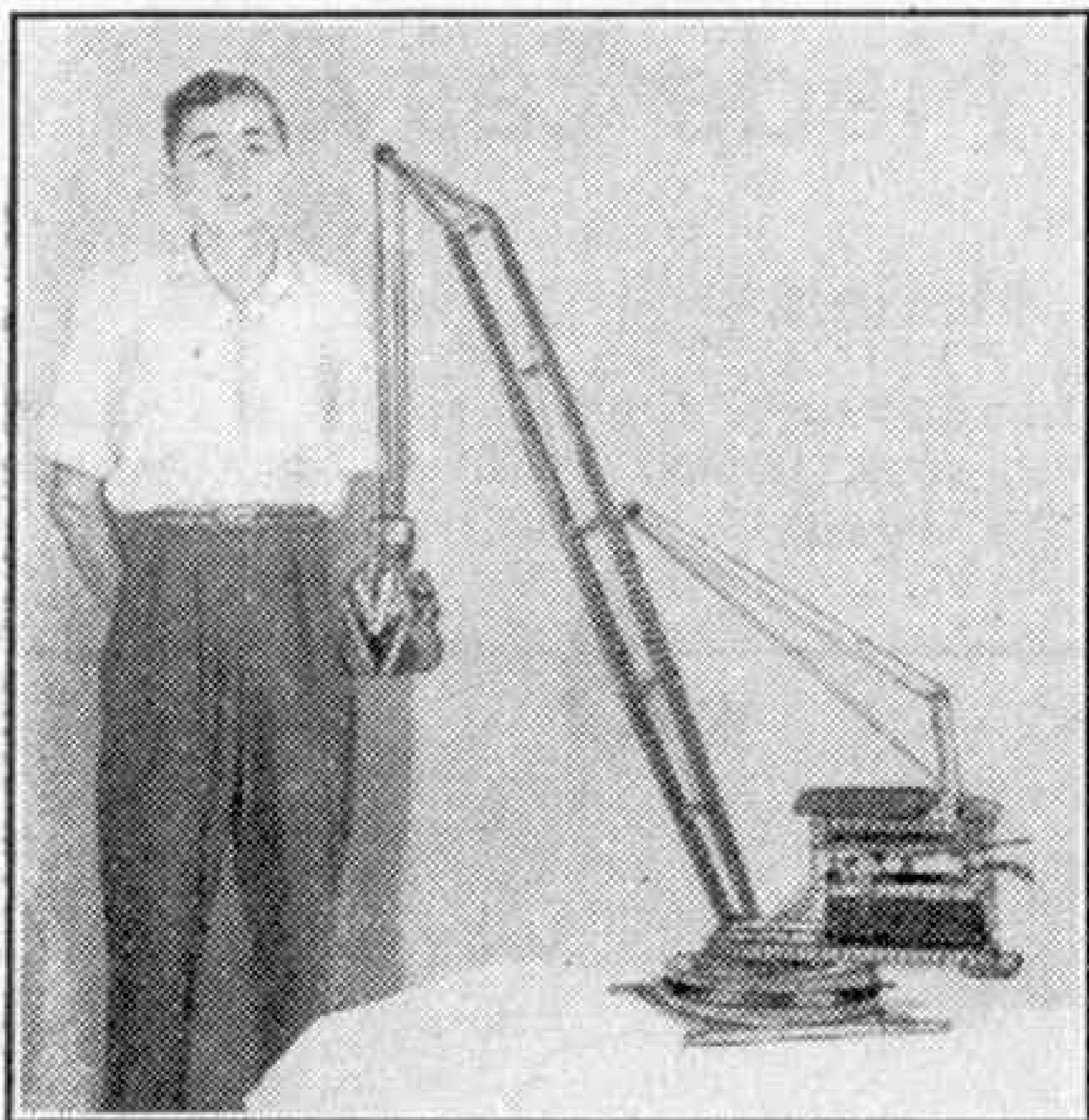

Fig. 3. D. W. Tyler, Waltham Cross, seen with his model crane, in which he used the ingenious automatic brake shown in Fig. 5.

$\frac{1}{2}$ " Pinion arranged as shown. By sliding Rod 2 the drive can be transmitted to either of these Rods. When Rod 2 is moved to the right, Gears 6 and 7 engage and so transmit the drive to Rod 4, and at the same time Pinion 8 engages 57-tooth Gear 3. As the Gear 3 is prevented from turning by its Threaded Pin, the Rod 5 also is locked. Movement of Rod 2 to the left brings Gears 6 and 9 into mesh, and engages the 57-tooth Gear with Pinion 10 on Rod 4, thus driving Rod 5 and preventing Rod 4 from turning.

A Gearless Reversing Mechanism

When a *Magic Motor*, which is non-reversing, is used for driving a small

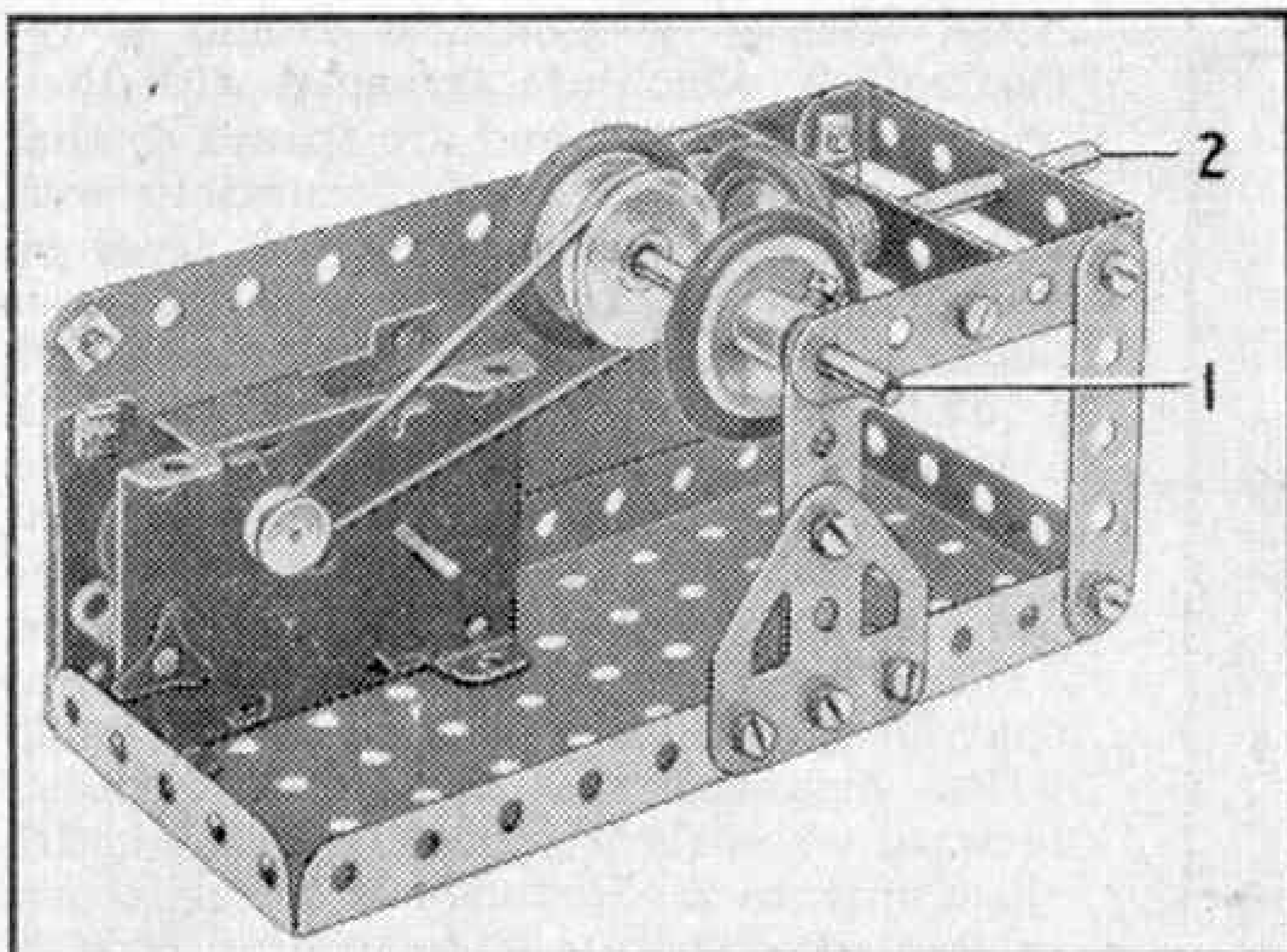

Fig. 4. A simple friction drive reversing device that can be used for raising and lowering the load hook in a small model crane.

model such as a crane, a simple reversing mechanism that does not require any gears can be built up on the lines shown in Fig. 4.

The drive from the Motor is taken to a Rod 1 on which are fixed two 1" Pulleys each fitted with a Rubber Ring. This Rod is arranged so that it can be moved endways in its bearings, so as to bring either of the 1" Pulleys into contact with a third 1" Pulley fixed on a Rod 2 placed at right angles to Rod 1. The direction

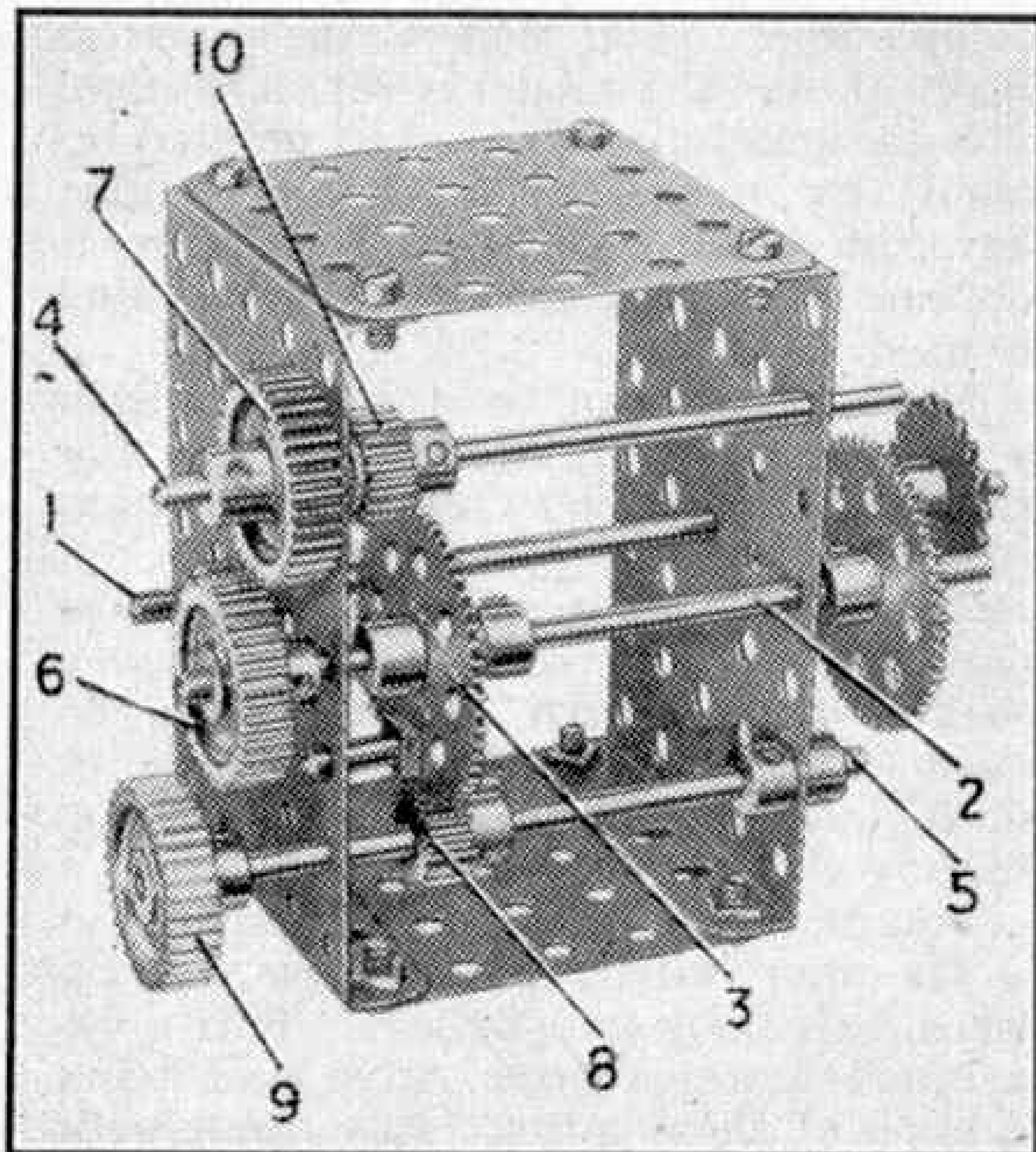

Fig. 5. The automatic brake mechanism for cranes designed by D. W. Tyler, Waltham Cross. It is described on the opposite page.

of the drive can be changed by sliding Rod 1 as required.

How to Use Sprocket Chain

Meccano Sprocket Chain provides a very convenient and simple method of transmitting power between shafts placed at some distance from one another. The Chain can be divided into shorter pieces by prising open the lugs of one of the links with a Screwdriver. To make an endless Chain the opened lugs are then hooked over the link at the other end of the Chain and bent back to their former shape. The Chain should be passed around the Wheels so that the turned over ends of the links face away from the Wheels, as this will result in smoother running.

Model-Building Made Easy

By "Spanner"

Driving Your Models

CONSTRUCTING a Meccano model is a fascinating pastime. Piece by piece the builder is able to watch it forming beneath his hands as the Strips and other parts are bolted together and the whole model gradually reaches completion. Then comes the greatest thrill of all—the model is set in motion!

Some small models can be operated by hand, by means of a Crank Handle, but the greatest fun and realism is obtained when a motor of some kind is used.

Most models can be driven by either a Clockwork or an Electric Motor. For those that are very small and light the motor can be connected by a Cord Belt passed over a small pulley on the motor shaft, and over a larger pulley on the driving shaft of the model. In most cases a 1" Pulley on the motor shaft and a 3" Pulley on the model shaft will be found satisfactory.

For driving many kinds of models, it is far more satisfactory to use gearing instead of belts and pulleys. This gives a much more positive drive and there is none of the slip that may occur with belts. Gears also make it easy to drive a model in either direction at will, and this is required for example in a crane for raising and lowering the load hook. A model vehicle, on the other hand, can be made to travel in either direction and

at two or more different speeds, if a simple gear arrangement is fitted in the drive from the motor to the rear wheel axle.

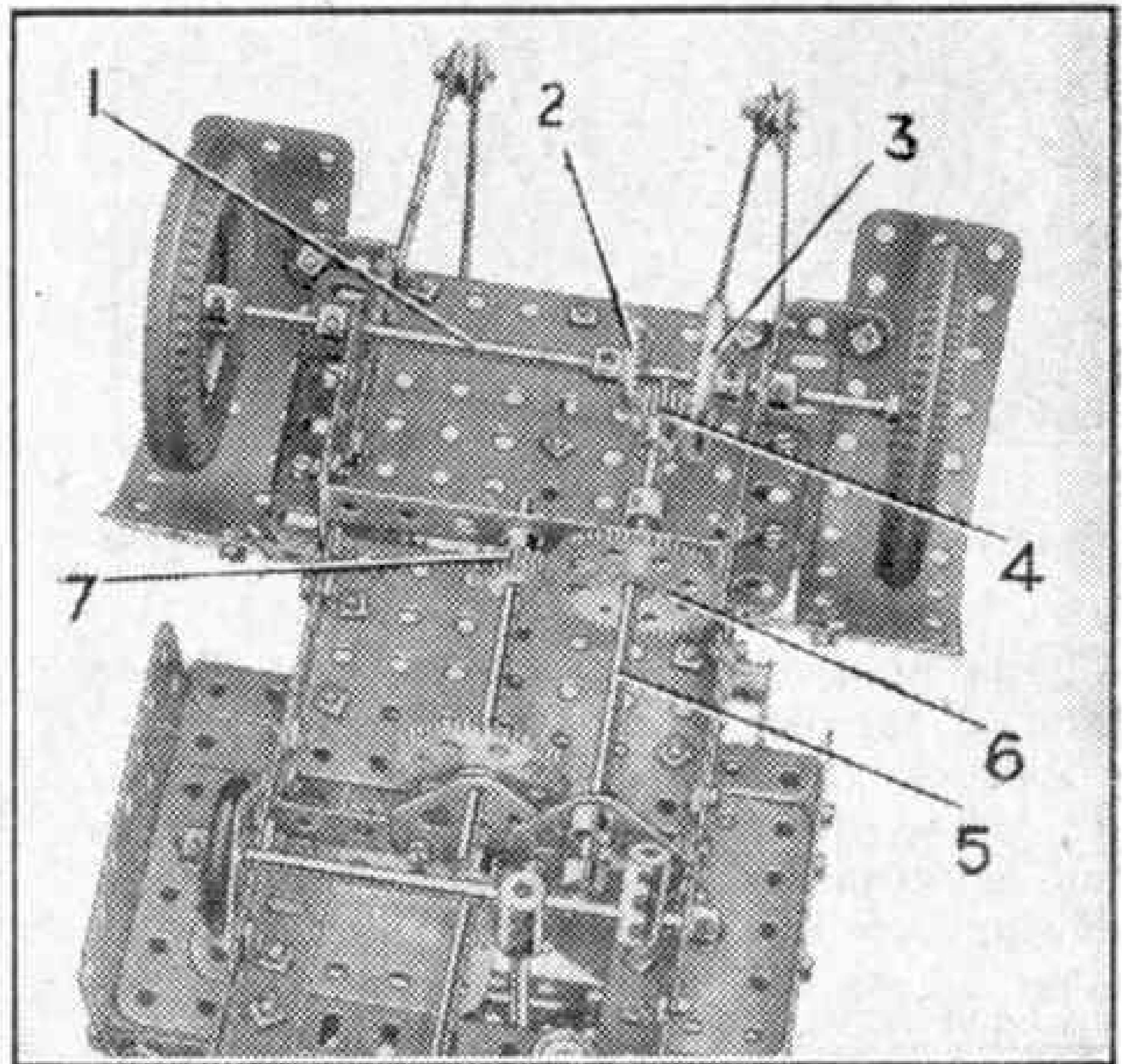

Fig. 1. A simple forward and reverse drive suitable for a small model car or the winding barrel of a crane.

A simple gear arrangement that allows the direction of the drive to be reversed is illustrated in Fig. 1. It is shown fitted in a model car, but it can also be used for driving the winding barrel of a small model crane, and for other purposes.

In Fig. 1 the rear axle of the model is fitted with a $\frac{3}{4}$ " Contrate 2 and a $1\frac{1}{2}$ " Contrate 3, which are arranged with their teeth facing inward and are spaced so that a $\frac{1}{2}$ " Pinion 4 will mesh accurately with either of them. The Pinion 4 is fixed on a Rod 5, which is free to slide endways about $\frac{1}{4}$ " in its bearings and is fitted with a 57-tooth Gear 6. This Gear engages a $\frac{1}{2}$ " Pinion 7 fixed on a Rod driven by the Motor. It is important to make sure that the bearings for Rods 1 and 5 are at the same height, so that the Rods are in line.

The sliding movement of Rod 5 is controlled by a lever, and the drive should be so arranged that the vehicle travels forward when the Pinion 4 is engaged with the Contrate 2. Pinion 4 is brought into mesh with Contrate 3 by sliding Rod 5; this reverses the drive to the axle and lowers the ratio to (Continued on page 94)

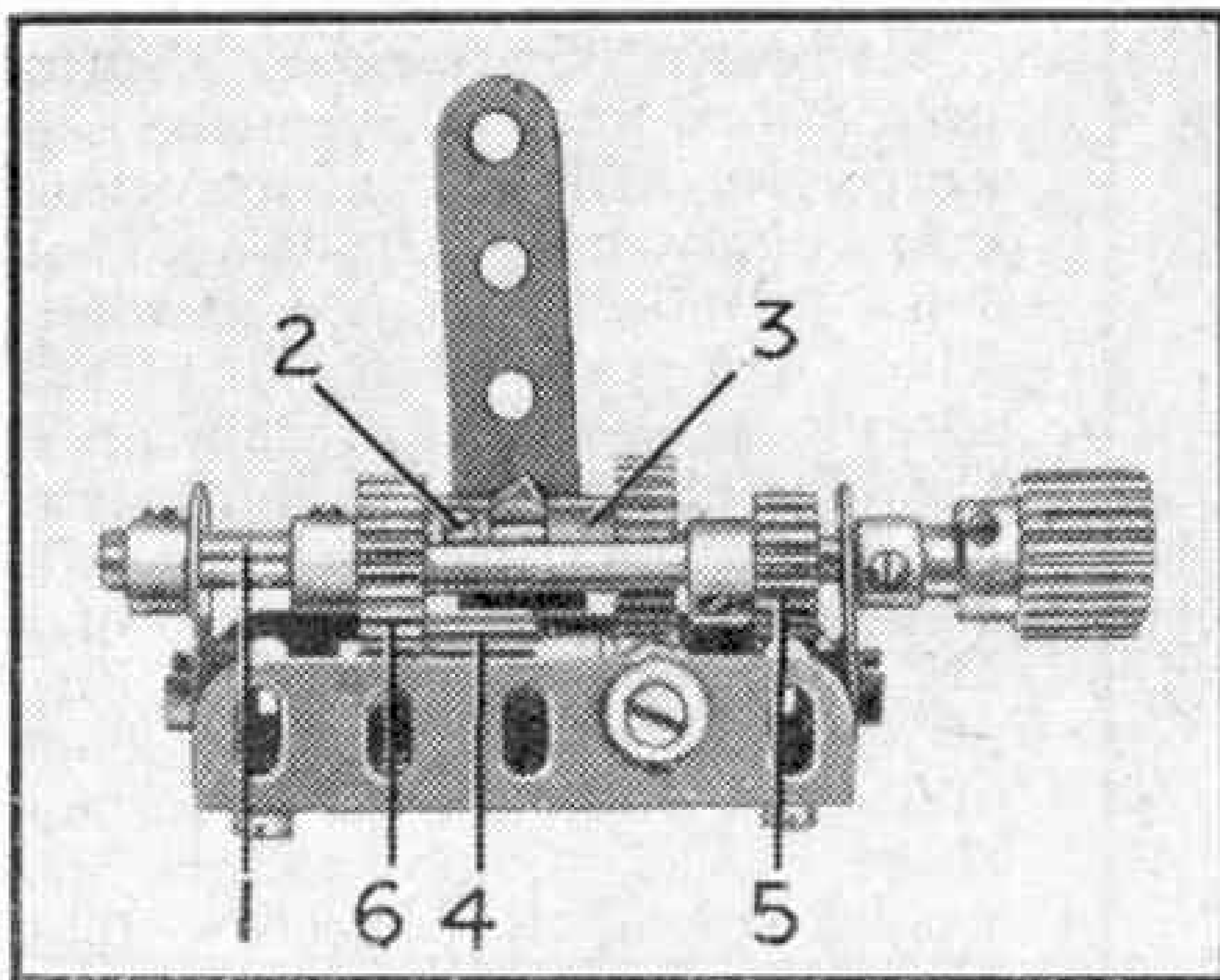

Fig. 2. A neat arrangement of gears that gives a forward drive at two different speeds and a reverse drive.

September Model-Building Contest Prize-Winners

By "Spanner"

The complete list of prize-winners in the Home Section of the September General Model-Building Competition is as follows:

First Prize, Cheque for £3/3/-: J. Barringer, Luton.
Second Prize, Cheque for £2/2/-: P. Lewis, Flamborough. Third Prize, Cheque for £1/1/-: K. S. Willett, Canterbury.

Ten Prizes each of 10/6: D. Gardiner, Lincoln; K. Holden, Belfast; J. A. MacDonald, Derby; J. A. Heywood, Macclesfield; K. Jennings, Cambridge; H. W. Henry, Rochester; A. A. C. Brewis, London W.11; W. H. Stewart, Edinburgh; D. Shaw, Saintfield, Co. Down; S. Hough, Melton Mowbray.

Ten Prizes each of 5/-: O. D. Gates, Aberdare; J. H. Pennington, Llanishen, Cardiff; A. Jones, New Quay, Cards; K. Streeter, Horsham; A. Fiddler, Billbrough, Nr. York; T. Johnson, Rotherham; R. Brown, Oakham, Rutland; F. G. Glass, Croydon; K. A. Webb, Orpington; R. Yates, Hounslow.

Many working clocks of various types have been built in Meccano, but most of them have been the work of model-builders with many years of experience. It was therefore very pleasing to me to find an excellent model of a grandfather clock built by a 12-year old competitor, John Barringer, Luton, obtaining First Prize in the September General Model-Building Competition. The clock is driven in the customary manner by falling weights, and has an escapement wheel consisting of a Faceplate with eight Reversed Angle Brackets bolted to it. The pendulum is made up from three 12½" Rods and two 8" Rods, with a bob formed by Flanged Wheels, and the hour and minute hands are driven through a very neat arrangement of gears and Sprocket Wheels and Chain.

I congratulate John on his success and shall look forward to seeing other examples of his work in future contests.

Second Prize was awarded for a model of a very

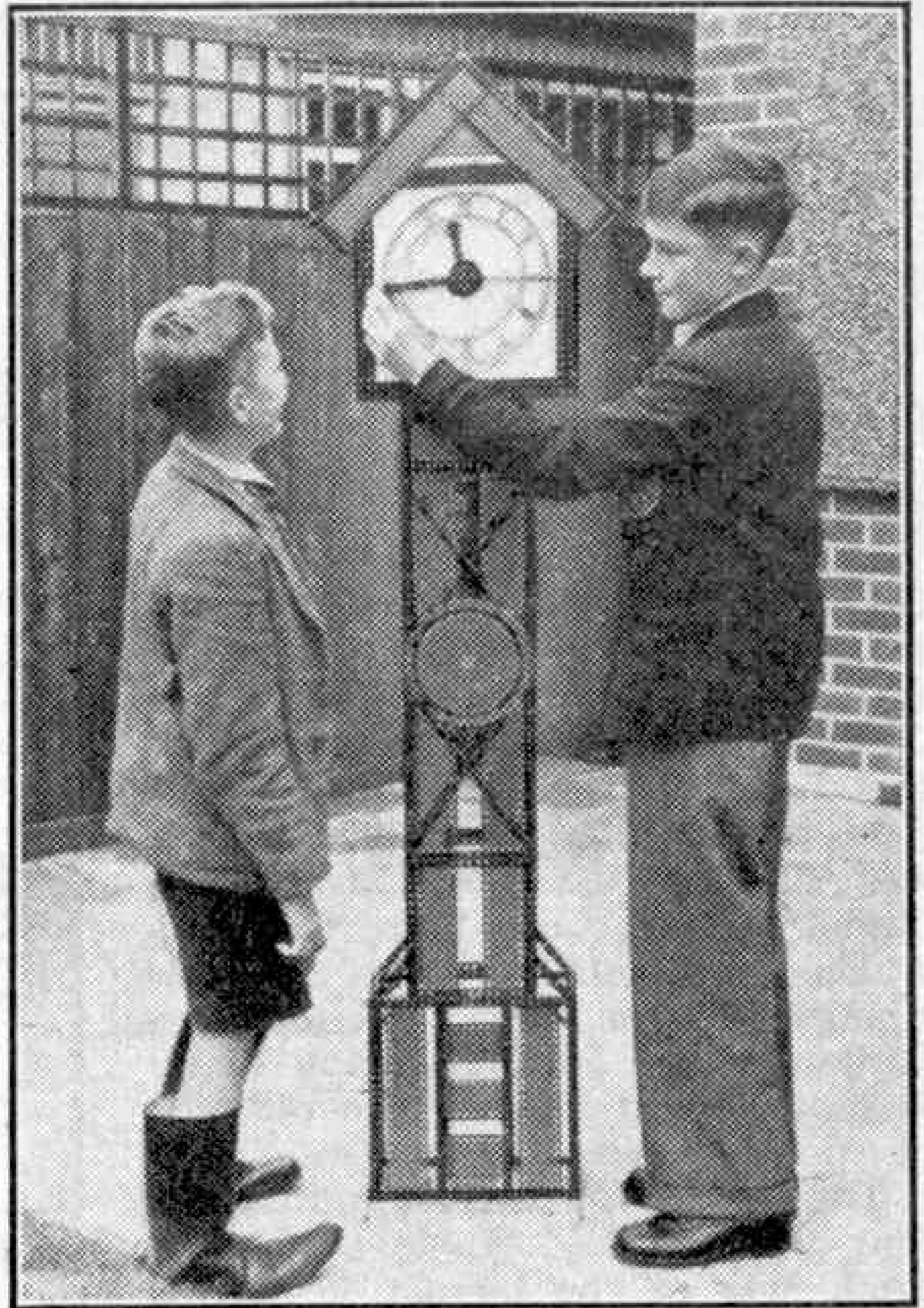

John Barringer, Luton, displaying to a friend the fine model clock with which he won First Prize in the September General Model-Building Contest, and which is dealt with on this page. Photograph by courtesy of Home Counties Newspapers Ltd.

different type. It is a corn reaper and binder, and is the work of Peter Lewis, Flamborough. The model has a cutter knife, sails, band-box and packers, and also discharge arms to throw out the sheaves of corn.

This model is one of the most detailed of its kind that I have seen among competition entries. Peter is only 13 years of age, and the neat and compact manner in which he assembled the various mechanisms well merits the success that his model achieved.

Agricultural machines also formed the subjects of the entry of K. S. Willett, Canterbury, who won Third Prize. In this there were three models, a potato spinner, a sorter and a sack lifter. The models were judged on their combined merits, and have many points of interest although they are not quite so neatly constructed as the entries that won the two higher awards.

Unfortunately space does not permit me to describe all the other prize-winning entries, many of which were well worthy of individual mention.

A COMPETITION REMINDER

There is still time to send in entries for the Christmas Competition announced in the December 1951 "M.M." The Competition is for Meccano models of all kinds and is open to all owners of Meccano Outfits. Special Cash Prizes are offered for the best models received. These prizes are as follows: First, Cheque for £5 5s. 0d.; Second, Cheque for £4 4s. 0d.; Third, Cheque for £2 2s. 0d.; 20 prizes each of a Postal Order for 10/-, and 25 Consolation awards. The last day for receipt of entries is 31st March. Entries should be addressed: "Christmas Model-Building Contest, Meccano Ltd., Birnns Road, Liverpool 13."

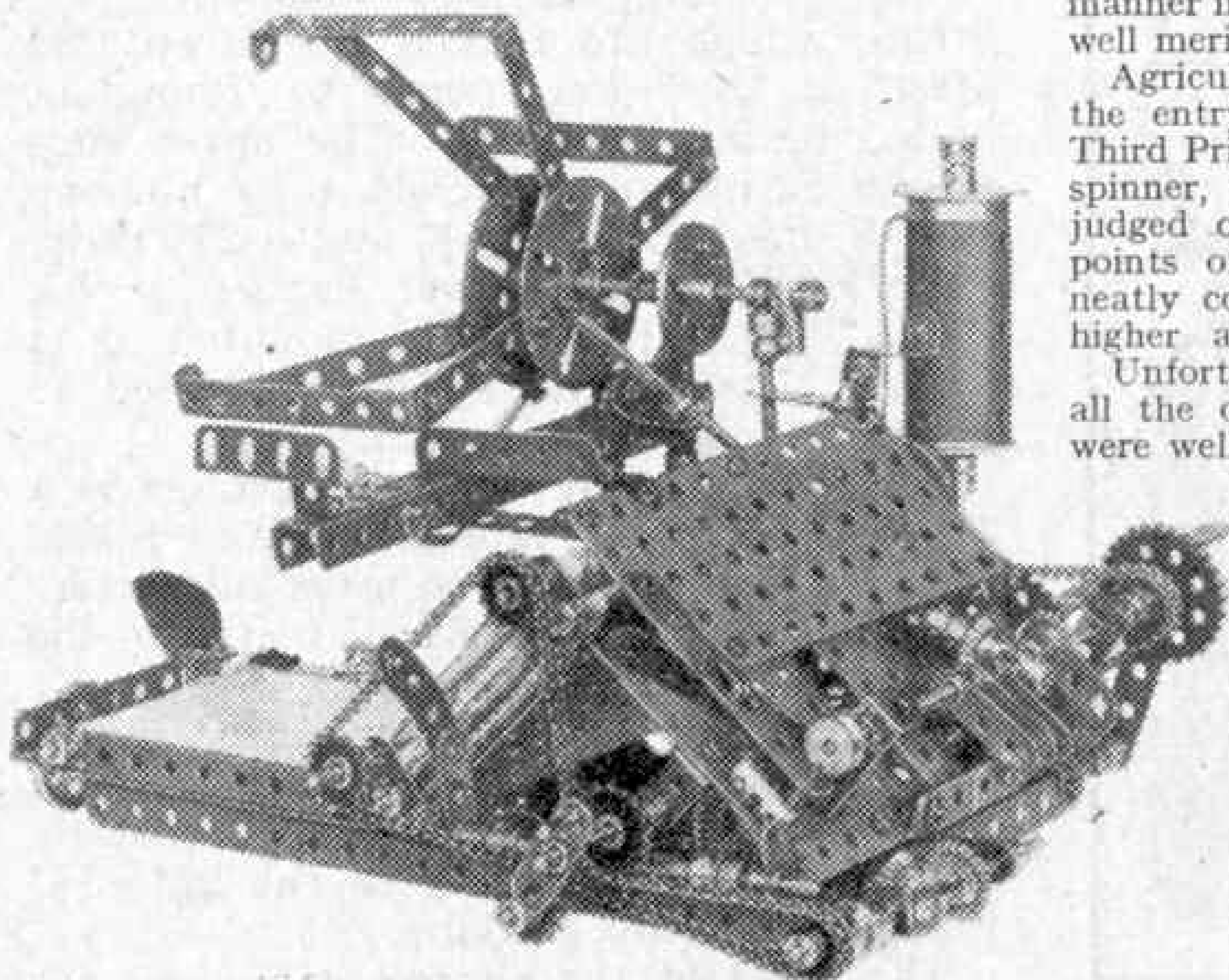

A model reaper and binder built by Peter Lewis, Flamborough, who was awarded Second Prize.

New Meccano Model

Coaling Plant from Outfit No. 7

ALL the parts required to build the locomotive coaling plant shown in Fig. 1 are contained in a Meccano Outfit No. 7. The base of the model is formed from two $12\frac{1}{2}$ " Angle Girders 1 and 2 bolted to two $12\frac{1}{2}$ " Strips and a $12\frac{1}{2}$ " \times $2\frac{1}{2}$ " Strip Plate 3. Two more $12\frac{1}{2}$ " Angle Girders 4 and 5 are fixed across the base in the positions shown. Girder 4 is bolted direct to Girder 2 and one of the $12\frac{1}{2}$ " Strips, but Girder 5 is attached to them by Angle Brackets. Two $3\frac{1}{2}$ " \times $2\frac{1}{2}$ " Flanged Plates are fixed between Girders 4 and 5. One of the Plates is indicated at 6, and the other is positioned inside the control cabin.

The coal hopper is supported by four vertical $12\frac{1}{2}$ " Angle Girders 7. Each side of the hopper is formed by a $5\frac{1}{2}$ " \times $2\frac{1}{2}$ " Flanged Plate 8 and a $5\frac{1}{2}$ " \times $2\frac{1}{2}$ " Flexible Plate, and the back consists of two $5\frac{1}{2}$ " \times $2\frac{1}{2}$ " Flexible Plates

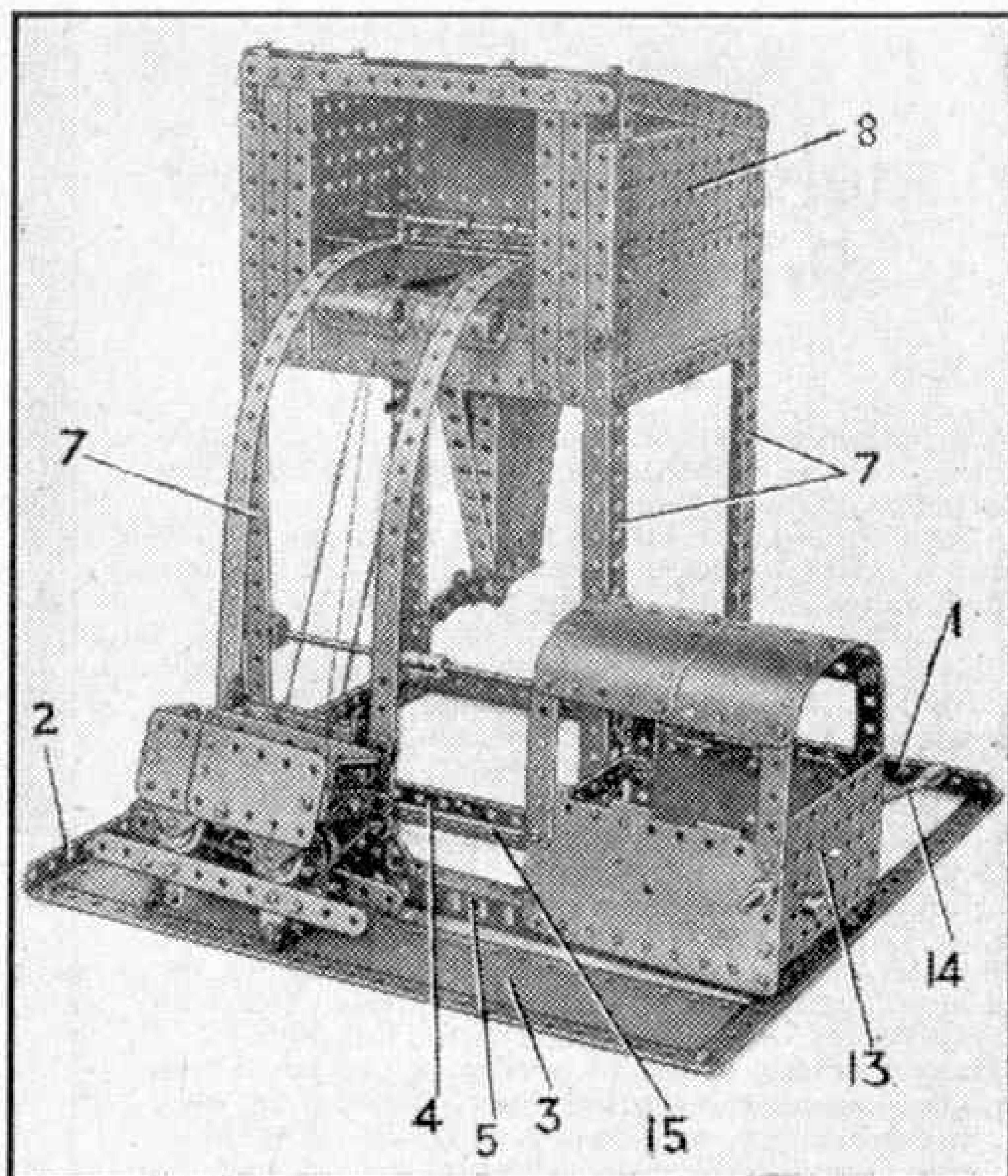

Fig. 1. A locomotive coaling plant built from parts in Meccano Outfit No. 7.

and two $2\frac{1}{2}$ " \times $2\frac{1}{2}$ " Flexible Plates. The sides and back are bolted direct to the Girders 7. The hopper front is partly filled in by a $5\frac{1}{2}$ " \times $1\frac{1}{2}$ " and a $2\frac{1}{2}$ " \times $1\frac{1}{2}$ " Flexible Plate, edged by two $5\frac{1}{2}$ " Strips overlapped, and by four vertical $4\frac{1}{2}$ " Strips. The upper ends of the $4\frac{1}{2}$ " Strips are connected by two overlapped $5\frac{1}{2}$ " Strips.

The hoisting carriage rails are $12\frac{1}{2}$ " Strips, which are curved as shown and fitted at their lower ends to Trunnions bolted to the Girder 5. The upper ends of the Strips are attached to a built-up strip 9, made from a $5\frac{1}{2}$ " and a $2\frac{1}{2}$ " Strip, and bolted to the lower flanges of the Plates 8. A Rod 10 is mounted in a $3\frac{1}{2}$ " \times $\frac{1}{2}$ " Double Angle Strip attached to Fishplates fixed to the Strip 9.

The back of the hoisting carriage is a $2\frac{1}{2}$ " \times $1\frac{1}{2}$ " Flanged Plate fitted at each side with a $3\frac{1}{2}$ " Strip 11. The forks supporting the truck rails are $2\frac{1}{2}$ " Strips bolted to the lower ends of the Strips 11.

The carriage is loosely mounted on its guide rails by two sets of guides 12, each consisting of two $3\frac{1}{2}$ " Strips separated by three Washers and fixed to the $2\frac{1}{2}$ " \times $1\frac{1}{2}$ " Flanged Plate by $\frac{3}{8}$ " Bolts.

The sides of the control cabin are the halves of a Hinged Flat Plate, which are fixed to the Girders 4 and 5 and connected

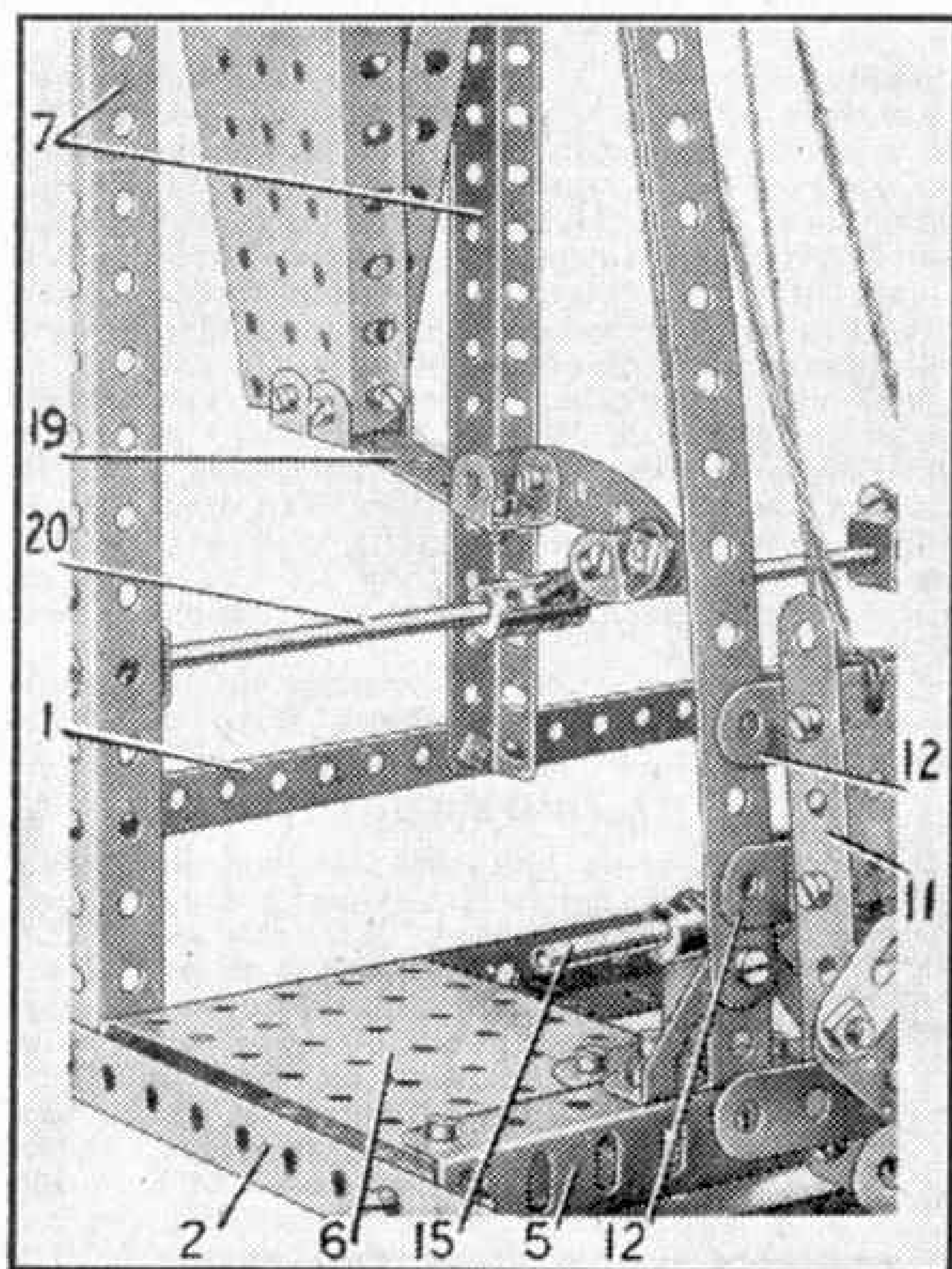

Fig. 2. A close-up view of the hopper discharging gear and control mechanism.

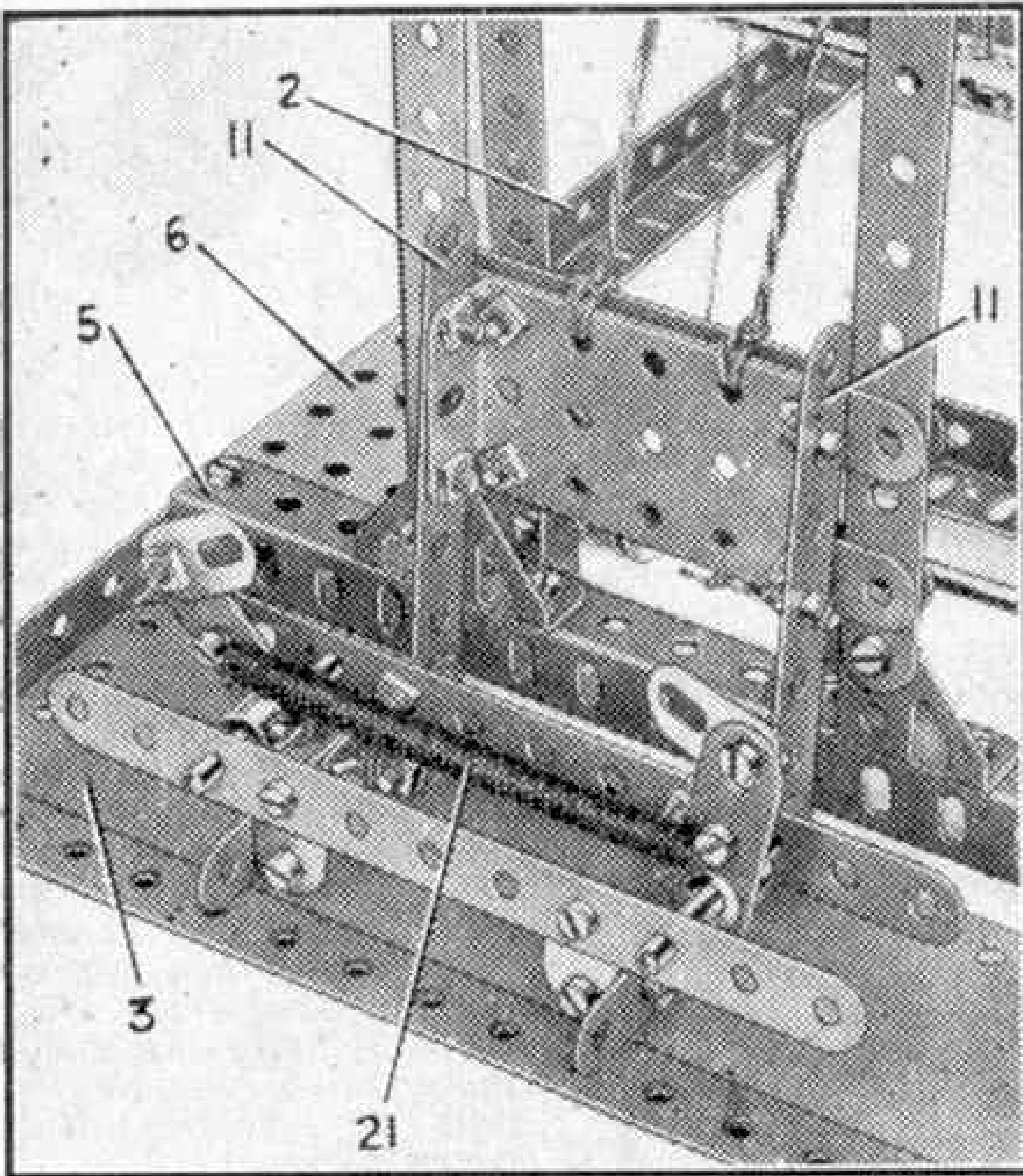

Fig. 3. An enlarged view of the hoisting carriage, showing the slides and the spring catch for holding the truck in position.

by a $3\frac{1}{2}'' \times 2\frac{1}{2}''$ Flanged Plate 13. The roof is made from two $1\frac{11}{16}''$ radius Curved Plates and two $2\frac{1}{2}'' \times 2\frac{1}{2}''$ Flexible Plates curved to shape, and it is supported by two $2\frac{1}{2}''$ and two $3''$ Strips.

The operating mechanism for the hoisting carriage is controlled by a Crank Handle 14, fitted with a Worm inside the cabin. The Worm meshes with a $\frac{1}{2}''$ Pinion on an $11\frac{1}{2}''$ Rod 15, which is mounted in Flanged Plate 13 and in a $1'' \times 1''$ Angle Bracket bolted to Plate 6. The Rod 15 carries two $1''$ Pulleys fixed behind the carriage.

The operating Cords are tied to the lower edge of the Flanged Plate that forms the back of the carriage, and each of them is passed twice round one of the Pulleys on Rod 15. The Cords are then taken over Sleeve Pieces 16 bolted to the hopper, passed round Rod 10 and tied to Driving Bands looped through the $2\frac{1}{2}'' \times 1\frac{1}{2}''$ Flanged Plate. The Driving Bands are stretched slightly to tension the Cords.

The sloping base of the hopper is next fitted. It consists of two $5\frac{1}{2}'' \times 1\frac{1}{2}''$ Flexible Plates 17 on each

side, connected by $2\frac{1}{2}''$ Strips. These Plates are attached by Angle Brackets to the front and back of the hopper. Two $2\frac{1}{2}'' \times 2\frac{1}{2}''$ Flexible Plates 18 bent as shown, complete the sloping base, and they are fixed by an Obtuse Angle Bracket and an Angle Bracket to the front and back.

The unloading chute is made from two Flanged Sector Plates bolted together at their narrow ends and connected by $1\frac{1}{2}''$ Strips at their wide ends. They are attached to the Plates 17 by Obtuse Angle Brackets. Two Double Brackets are fixed to the lower end of the chute, and these form a guide for a sliding trapdoor formed by a $2\frac{1}{2}''$ Strip 19.

A Double Bracket is fixed to Strip 19, and is connected by a Curved Strip and lock-nutted bolts to an Angle Bracket held by a nut on a $\frac{3}{4}''$ Bolt. The $\frac{3}{4}''$ Bolt is screwed into a Coupling used to connect two $4''$ Rods 20, which are mounted in Double Bent Strips bolted to two of the Girders 7. A Bush Wheel fitted with a Threaded Pin forms an operating handle for the trap.

The sides of the coal truck are each made from two $2\frac{1}{2}'' \times 1\frac{1}{2}''$ Flexible Plates joined by $1\frac{1}{2}'' \times \frac{1}{2}''$ Double Angle Strips. The bottom of the truck is formed by two Semi-Circular Plates attached to the sides by Angle Brackets. The wheels are fixed on $1\frac{1}{2}''$ Rods mounted in Flat Trunnions.

The truck rails are connected to the carriage by Fishplates and Angle Brackets, and a catch to hold the truck in place is made from two (Continued on page 94)

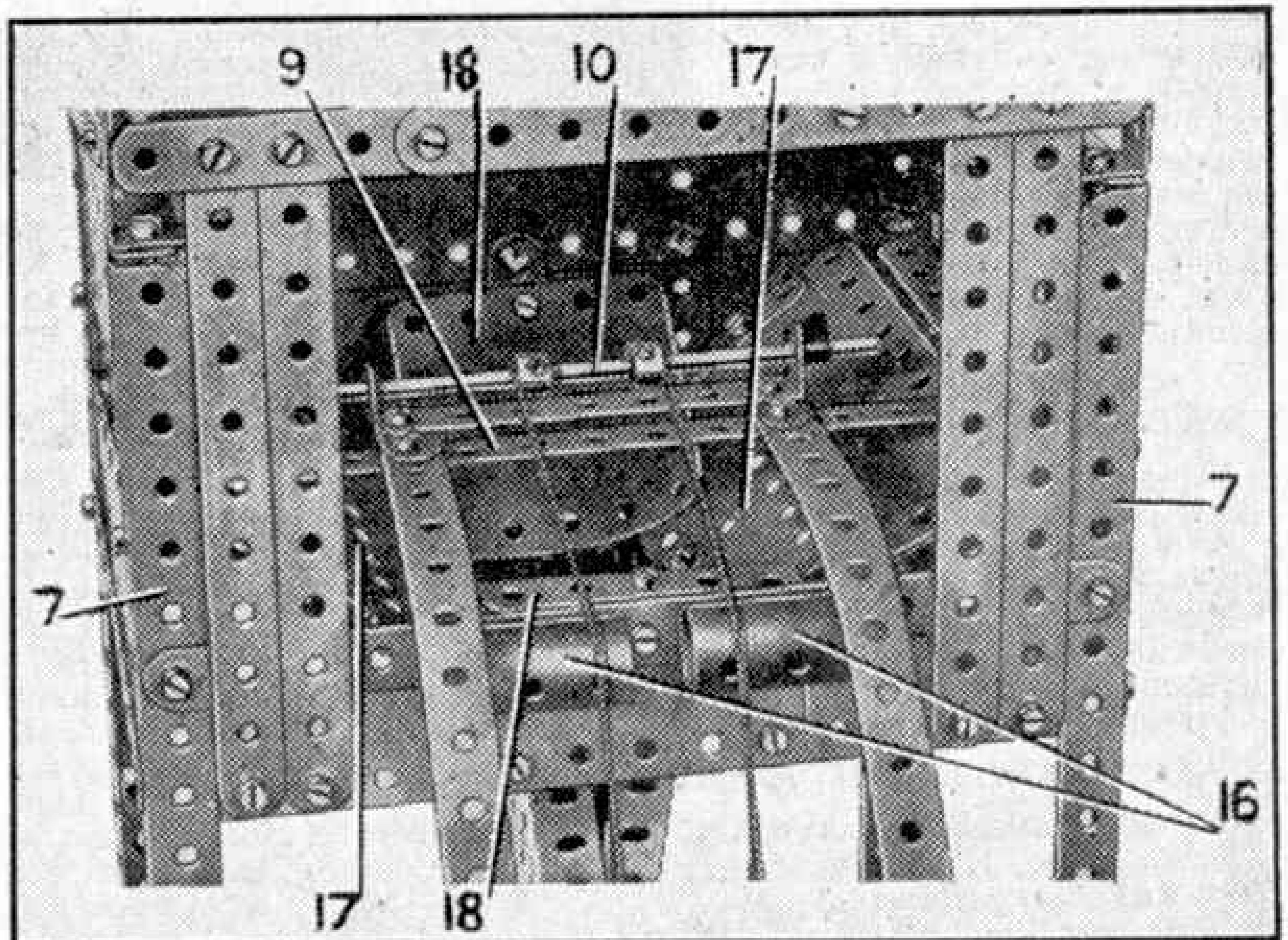

Fig. 4. The hopper seen from the front, showing the Rod and Sleeve Pieces over which the carriage hoisting cords pass.



Club and Branch News



WITH THE SECRETARY

SMALL CLUBS AND BRANCHES

Last month I urged members of the Guild and of the H.R.C. to do their utmost to form new Clubs and Branches. I have already received enquiries from more interested enthusiasts, and I want to make it clear to all that they should not hold back from their efforts because they think they cannot form a large Club or Branch at once. Like most organisations, Clubs and Branches should grow. Those that are most successful are built up from small beginnings by the efforts of the enthusiasts who start them and of others who join in the good work.

The great idea of the formation of a Club or Branch is that the delights of model-building and miniature train operation are wonderfully increased when the hobbies are carried on in conjunction with others interested in them. A group of only half a dozen friends can have the greatest fun if they meet regularly for this purpose, and those who are thinking of making a start on a small scale should have no fear that they will be regarded as unimportant. In fact, our President, Mr. Hornby, and myself are specially interested in these little friendly Clubs and Branches, which embody the real spirit of the Guild and of the H.R.C. in that the members are helping each other to get the utmost from their grand hobbies.

Those who have already made a start should write now to tell me how they are getting on, and how I can help them. Members who are thinking of following their example also should write to me for information, and for a copy of a special booklet that explains what Meccano Clubs are and how they are formed and carried on.

MECCANO CLUBS RECENTLY AFFILIATED

- NIJMEGEN (HOLLAND) M.C.—
—Mr. H. Hendriks, Hertogstraat 114, Nijmegen.
ST. LEONARDS M.C.—Mr. W. Batchelor, 15, Bruce Street, St. Andrews, Fife.
MEMOKA (HOLLAND) M.C.—Mr. M. Visser, N.Z. Burgwal 33, Monnikendam.
JAMES STREET (EXETER) M.C.—Mr. M. C. Hodder, 3, Fords Road, Exeter.

RECENTLY INCORPORATED BRANCHES

- 532—NEW COLLEGE (HARROGATE)—S. J. Chambers
New College, Harrogate.
533—REDLAND (BRISTOL)—Mr. S. G. Wills, 38,
Clarendon Road, Redland, Bristol 6.
534—NEWCASTLE ROYAL GRAMMAR SCHOOL—Mr.
G. L. Beach, Newcastle Royal Grammar School,
Eskdale Terrace, Newcastle-on-Tyne 2.

CLUB NOTES

ST. LEONARDS (ST. ANDREWS) M.C.—This newly-affiliated Club is following a full programme, in which Model-building occupies the greater part of the time allotted to meetings. A Hornby Railway Section also is being formed and a layout is being constructed. Members were greatly interested in processes watched during a Visit to a Paper Mill. Club roll: 11. *Secretary*: Robert Laing, 2, Bowling Green Terrace, St. Andrews, Fife.

JAMES STREET (EXETER) M.C.—This Club was affiliated late last year and has made excellent progress. Members sorted out stocks of Meccano Parts and then began Model-Building, their productions including windmills, a baker's van, a bridge and a crane. Other meetings are being devoted to Talks and Debates. Club roll: 10. *Secretary*: B. Dart, 23, Temple Road, Exeter, Devon.

BELGRAVE UNION (LEICESTER) M.C.—The Club Exhibition was a wonderful success, nearly 1,000 visitors inspecting the display. Club models built by members were the chief attraction, and among them were a marine dockyard scene and a handsome model village and railway. Models were judged by Mr. F. S. North, President. Six Film Shows were given, all concerned with locomotives, track and signalling. Club roll: 44. *Leader and Secretary*: Mr. C. S. Smith, 18, Doncaster Road, Leicester.

BRANCH NEWS

JUNCTION ROAD SCHOOL (BRENTWOOD)—A splendid start was made this Session with a membership of 37. A model dockyard, including sheds, ships, etc., is being constructed, the project giving ample variety and interest to members. Club roll: 37. *Secretary*: John Clarke, 15, La Plata Grove, Brentwood, Essex.

MAGDALEN COLLEGE SCHOOL (OXFORD)—Two outstanding visits have been

made. On the first members inspected the repair shop of the Oxford W.R. Motive Power Depot, where they enjoyed a brief footplate trip on a "Grange." On the second one party visited the Rugby Test Plant and Control Office, while another inspected the Motive Power Depot and Works. *Secretary*: M. Gibbs, Oakdene, East Street, Headington, Oxford.

NEW ROAD (SOUTH CHINGFORD)—Enthusiasm continues high. It has been decided to run larger locomotives, and to allow this curves on the track have been given a larger radius, while the layout as a whole has been re-wired. Operations on it are now controlled from a panel above the layout, giving the controller a Signal Box view. *Secretary*: Mr. K. R. White, 136, Westward Road, South Chingford, London E.4.



A photograph taken during a visit to Southampton Docks by members of the Mile End (Portsmouth) M.C. with their Leader, Mr. A. J. Nicholson. The party travelled by water, and enjoyed excellent views of "Queen Elizabeth" on her way to New York, and of many other interesting vessels.

HORNBY RAILWAY COMPANY

That Second Engine

By the Secretary

I AM often asked by Hornby-Dublo enthusiasts how to make the best use of a second locomotive when they add to their stock of equipment. Now two engines cannot be run satisfactorily on the same track with one Transformer and Controller. While the main line remains single, one of them must be held in a section of the line, such as a siding or loop, that can be cut out electrically from the main circuit. This can be done easily by making use of the Isolating Rail and Switch. From such simple beginnings a realistic working system can be built up incorporating such features as the attractive station layout illustrated on this page.

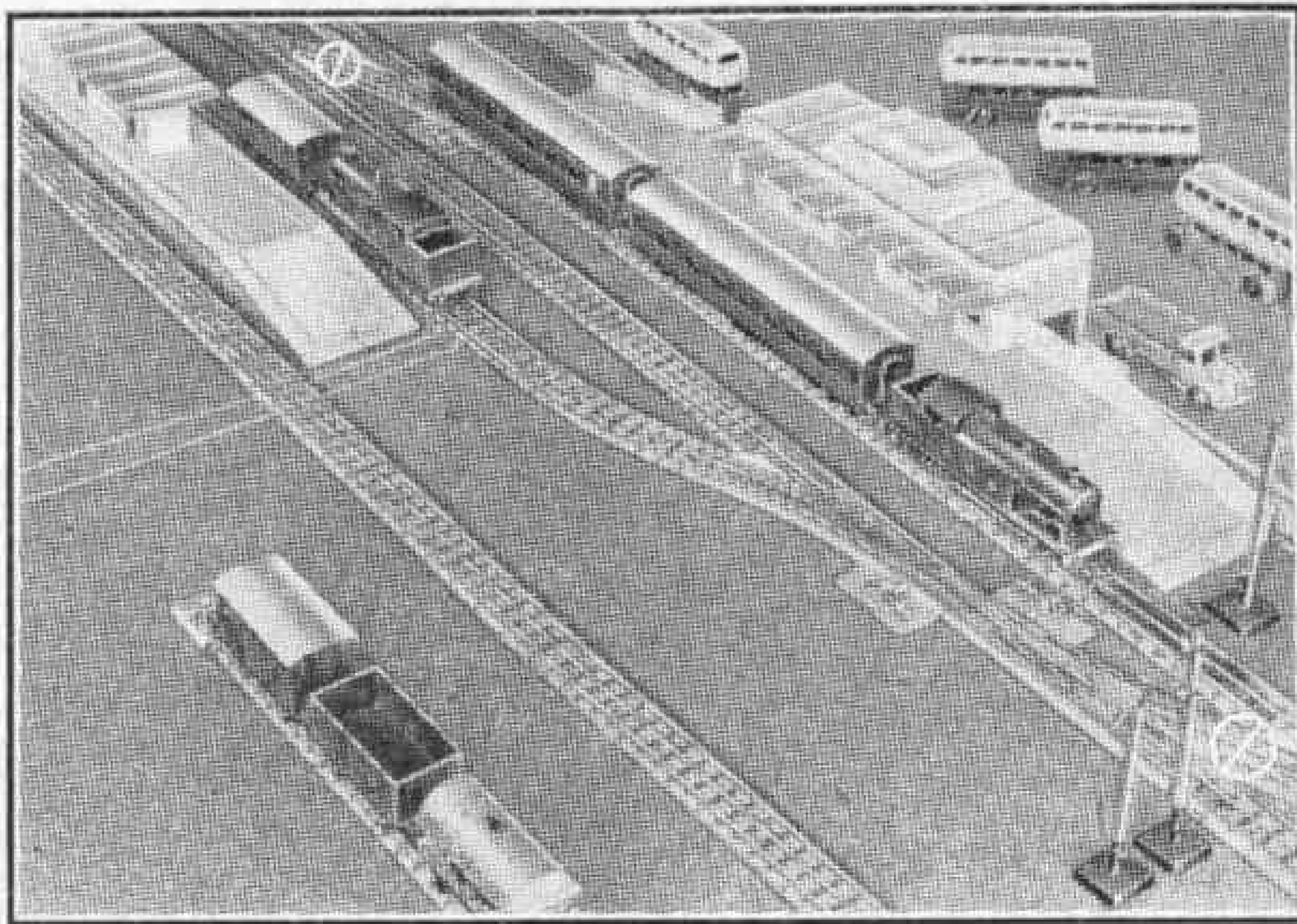

A Hornby-Dublo Station layout with crossover connections and a loop line as described on this page. The locations of the Insulating Tabs are specially marked by the "circle and bar" indication.

In a scheme of this kind, if independent working on a double track main line is required, a separate Transformer and Controller is necessary for each track. Then the two engines can be run at the same time, each on its own main track.

So far, so good; but what happens if we want to join the two main tracks by means of Points forming a crossover? We cannot have the two Transformers and Controllers connected to the combined circuits; so, to preserve the independent control scheme, we must have a break in the centre rail section between the Points.

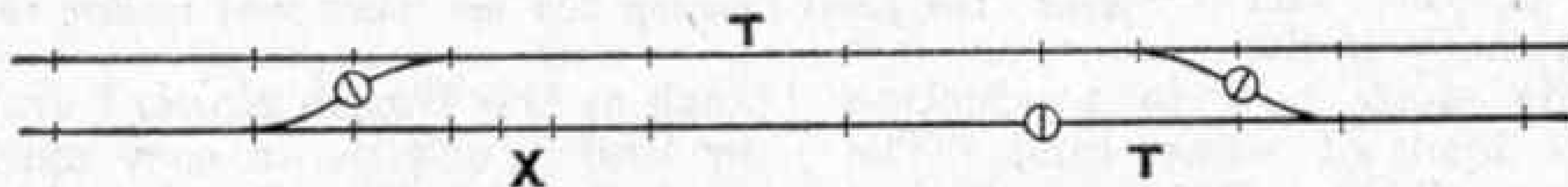

Insulating Tabs, represented by circles with diameters, on a double track layout. The terminal rails are marked T. In the lower track is a section with an Isolating Rail X connected to a switch.

and is very simple to use. It is just slipped in between the centre rail clips, as shown in the illustration at the foot of this page. There it intervenes between the centre rail connecting clips and so makes the necessary break.

These Tabs can be used over and over again, as may be necessary when layout designs are changed. The Tabs are just the thing also for forming loop lines into separate electrical sections, each controlled by an Isolating Rail and Switch. In this case the Isolating Rail provides the break at one end of the loop, and the

Insulating Tab is placed at the other end. The diagram in the centre of this page shows a typical arrangement of similar character on a main line.

With Isolating Rails and Switches and Insulating Tabs therefore it is easy to divide a layout so that two locomotives can be moved simultaneously, remembering of course that each section must have its own Transformer and Controller. When necessary each locomotive can pass to the other track without difficulty, transfers being made at reduced speed.

In the railway seen in the upper illustration on this page there are two main lines, connected by Points forming two crossovers, and with Insulating Tabs correctly placed to provide breaks. One of the main tracks serves the Through Station platform, and a loop off the other with an Isolating Rail and Switch at one end and a Tab at the other, serves the Island Platform.

Each main line has its own Transformer and Controller—these are not visible in the picture, by the way—and the L.M.S. Tank shown arriving can run round its train for the return journey when the train already signalled on the other main line has been disposed of in an isolated section. While these operations are in progress the engine and Goods Brake Van seen waiting in the loop are isolated until the main line is clear.

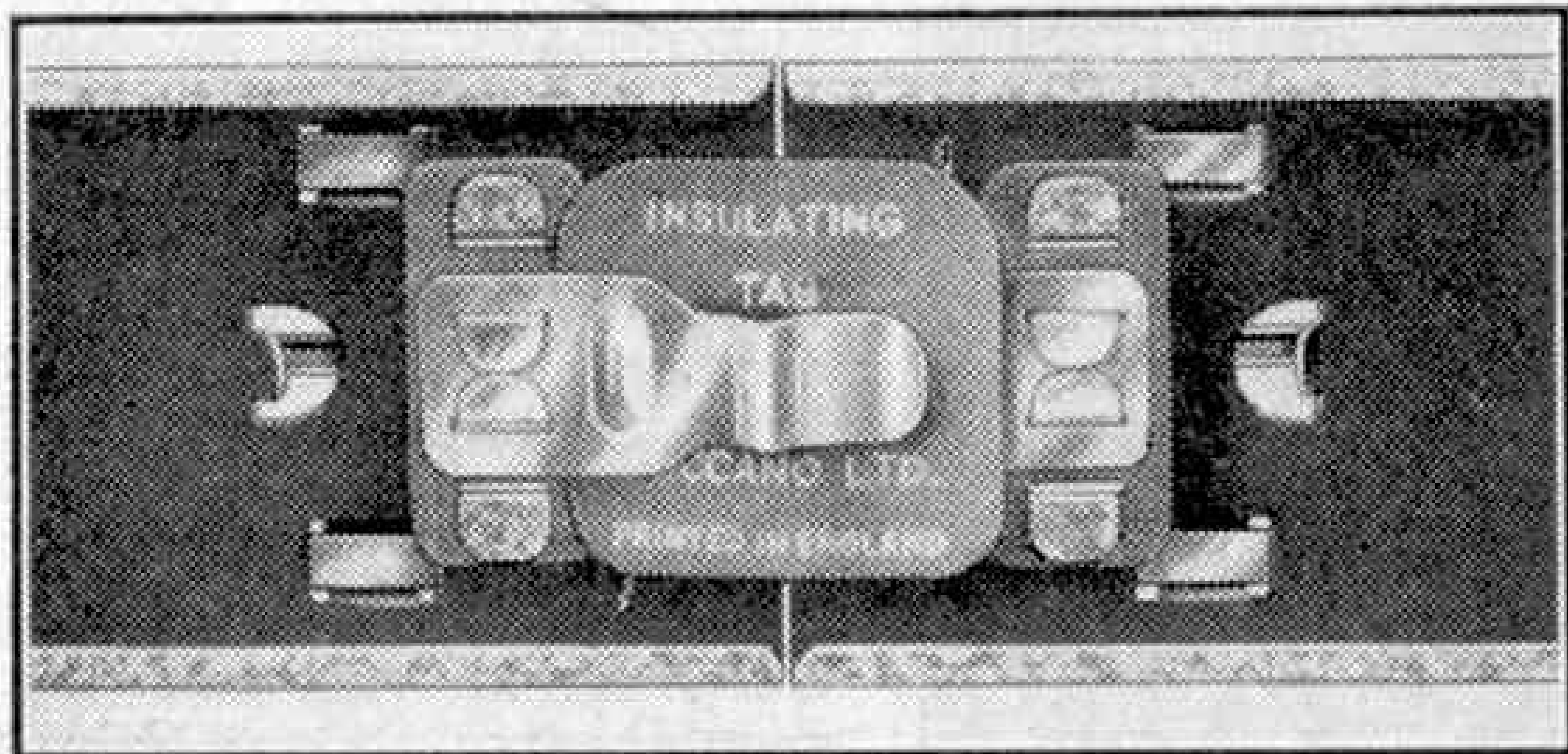

How to place the Insulating Tab in position between the centre rail connecting clips.

Using Hornby Rolling Stock

THE name rolling stock applies in general to all the vehicles that the youthful Hornby Railway beginner is usually happy to consider simply as "trucks." The distinction between the different types, for passenger and for goods service, usually comes a little later in his experience. Then he begins to look out for this type or that in order to provide some variety in the vehicles, especially those for goods traffic.

The varied stock included in the Hornby 201 Tank Goods or 601 Goods Train Sets gives a miniature railway owner a good start. To the tank set there can be added a Goods Brake Van and to the other set a Goods Van or some similar vehicle. Loads usually receive early attention from the beginner and most of the Hornby goods stock now in production can carry a load of some kind. The different Vans, Goods, Refrigerator and Milk, have sliding doors, and the last-named one, as bought, already has some milk cans on board. For the others, all sorts

of little oddments can be popped inside to represent different consignments. Don't pack the goods too tight in your Vans or you may have trouble in unloading later!

Loading or unloading the open vehicles

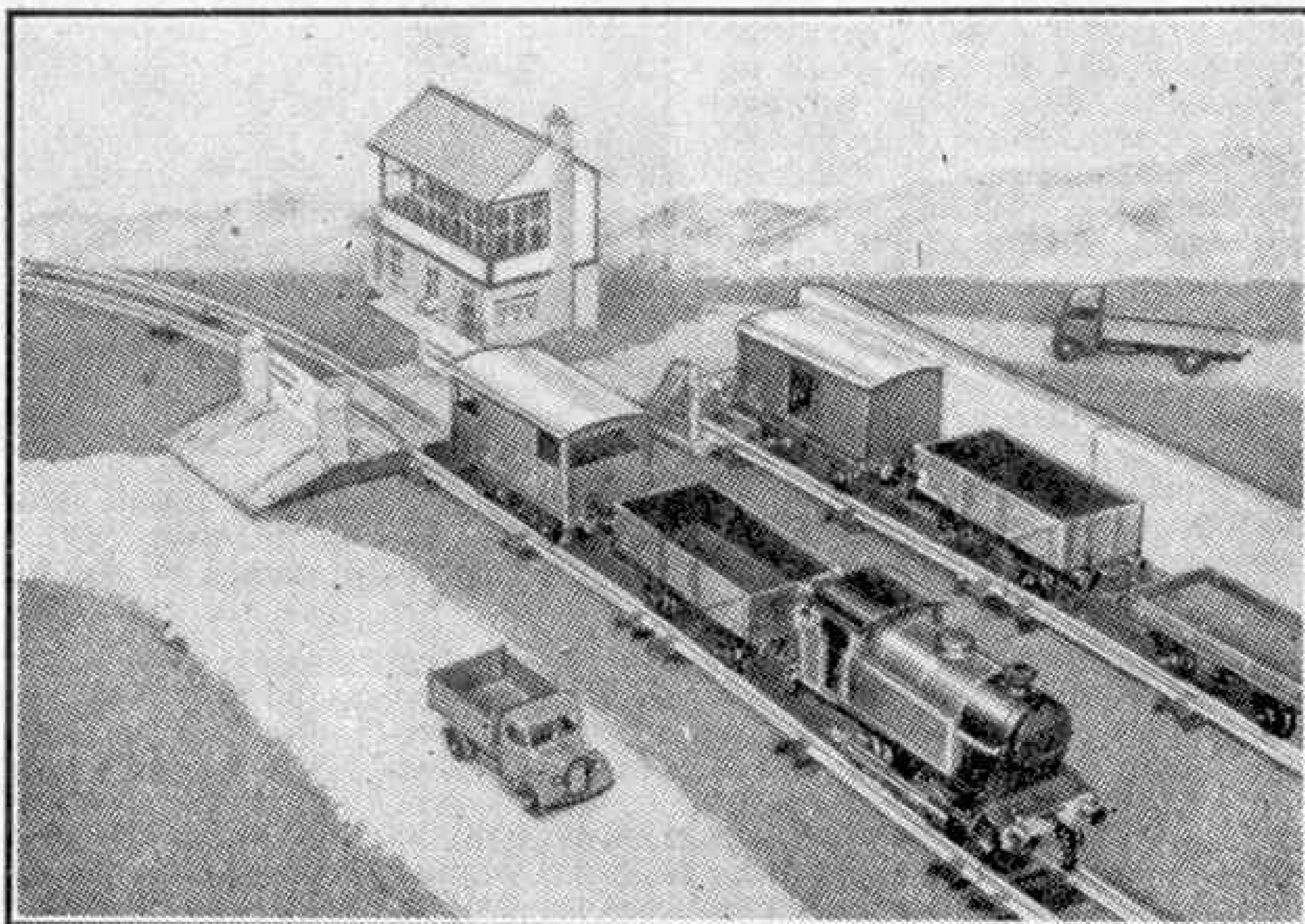

A Hornby Tank Locomotive on its way to pick up more wagons to form a train. The Level Crossing and the siding lend realism to the scene.

such as the Wagon No. 1, Lumber, Timber or Flat Trucks is an easy matter, as it is carried out literally by hand. When there is a Coles Mobile Crane (Dinky Toys No. 571) available, this can do good work either in the yard or on the loading platform.

Passenger stock is not so varied, but an additional Coach No. 1 or Passenger Brake Van can always be used with advantage. Where there are several such Vans on the line they can form quite a realistic parcels train. Goods-type vehicles sometimes appear on real passenger or parcel trains. The Goods, Refrigerator or Milk Van can be used in this way, and each can display the correct tail lamp if it happens to run at the rear of a passenger train.

Goods trains are completed by the Hornby Goods Brake Van, and this should carry its tail lamp and side lamps on the brackets provided.

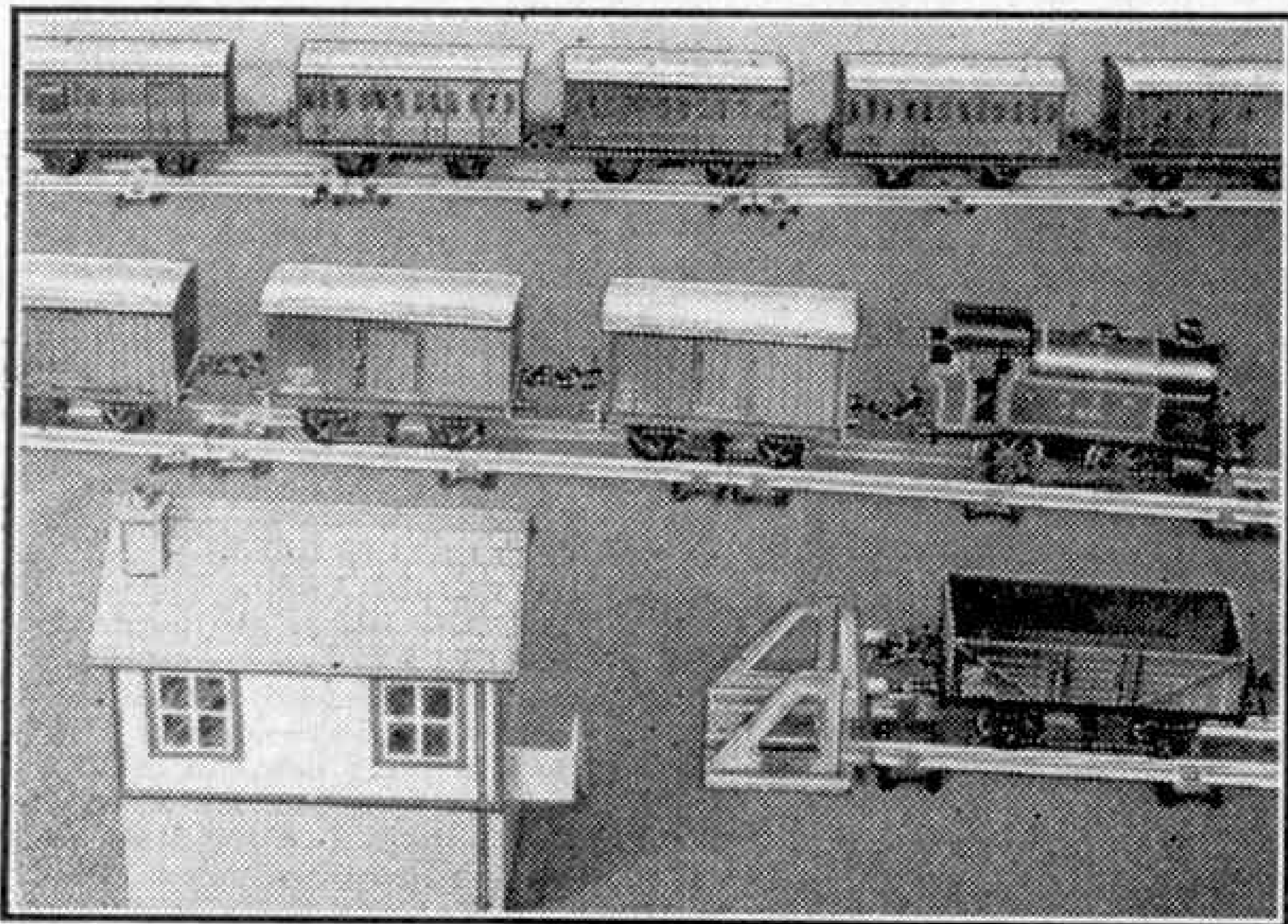

A train of vans is hurried past the Signal Cabin by a Hornby Tank Locomotive. Typical rolling stock is standing in the sidings.



A Hornby-Dublo Town and Country Layout

THE Hornby-Dublo layout shown in the illustrations on this page has been in course of development for over ten years. The owner, Mr. J. S. Guthrie, of Manchester, began with a single Train Set. At first progress was slow owing to war-time conditions, but by degrees a good system on a permanent baseboard has been built up.

The layout affords continuous running and there are, broadly, four main tracks all the way, with various loops and sidings. Each of these four main tracks has its own Transformer and Controller, while there are Isolating Rails and Switches that allow eleven engines to be on the railway at various points, although only four engines can be running at once.

Some time ago the railway was divided for operating purposes into two "regions." The outer pair of tracks form the "Eastern Region," worked by L.N.E.R. type locomotives and rolling stock. The inner tracks are known as the "Midland Region," worked by L.M.S. engines and stock.

If you were to go, in imagination, on the "Watfordian" express, you would start from "Victoria" Station, in a train hauled by a Hornby-Dublo "Sir Nigel Gresley." The first stop would be "Acton Road," a suburban station for the city. As far as this the train follows the same route as the Midland Region lines, but now crosses over a main road and comes into the country station of "Watford." Then the line runs into hilly country through a tunnel and reaches "Harbourne." After this the town is approached once more and you arrive back at Platform 3, "Victoria."

The chief Midland Region train is the "Royal Elm Express," hauled by No. 6231 "Duchess of Atholl." This leaves "Cross Street," which is actually next to "Victoria." After "Acton Road," this takes the straight track to the country station of "Carnforth." Then come a short tunnel and a straight length, and after rounding another curve the train is again at Platform 7, "Cross Street."

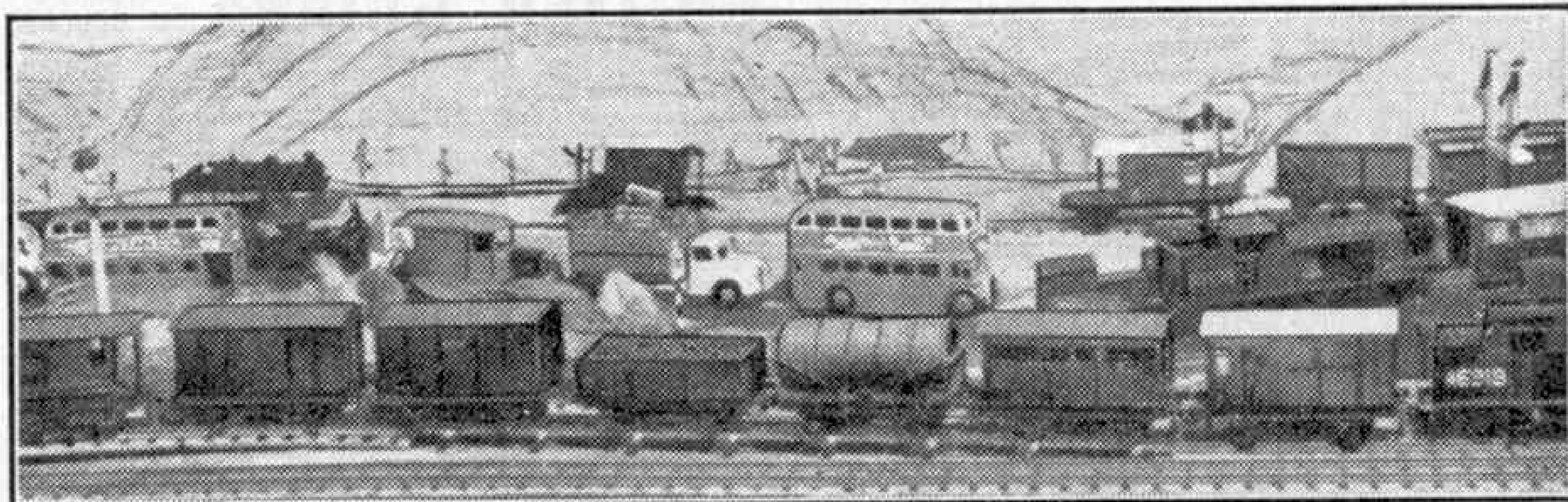

Realistic scenes on the Hornby-Dublo layout of Mr. J. S. Guthrie, Manchester, are shown in the illustrations on this page. The upper picture shows the rail and road approach to one of the main stations; in the lower view simple scenery makes an effective background to the line.

BARGAIN DISCOUNT APPROVALS!

We offer the largest and best selections of approvals you have ever seen—two large sheets of singles and a book of sets. They're post free one way, too, and a generous discount is allowed off purchases. All picked copies, "Wants" lists of SINGLE stamps welcomed. We will include what we can. Why not give them a trial? There's no obligation to buy and further lots are sent ONLY on request.

THE BIRKDALE STAMP CO.
104, Liverpool Rd., Southport, Lancs.



Postal Business Only

MOTOR COACH PACKET

ABSOLUTELY FREE



The magnificent stamp illustrated portrays the **FINNISH** Postal Motor Coach with driver and passengers, seldom seen in any collection. Other fine stamps from **FINLAND** are included, the beautiful scene of **LAKE**

SAIMA, historical **NYSLOTT CASTLE**, forestal scene with wood-cutter and finally a photographic view of the General Post Office at **HELSINGFORS**. These stamps will make a good display, they are all large high values. Enclose 3d. postage requesting Approvals. Price list will be sent on request.

LISBURN & TOWNSEND LTD. (MM), West Kirby, Wirral

FREE—NEW 2/6 GT. BRITAIN

Showing H.M.S. "Victory" will be given free to all genuine applicants for our famous **ONE PENNY APPROVAL BOOKLETS** of **BRIT. COLONIALS**. These Booklets abound with **JUBILEES, PEACE, CORONATIONS, SILVER WEDDINGS** and **U.P.U.** as well as the latest **K.G. VI** stamps. Many Bargains as usual. N.B.—Enclose 2½d. stamp for Postage.

S. FENLEY LTD., 250, Charminster Rd., Bournemouth

SPECIAL COUNTRY PACKETS

25 Argentine .. 9d.	10 Kenya .. 9d.
25 Australia .. 9d.	25 New Zealand 1/-
50 Belgium .. 9d.	25 Portugal .. 9d.
25 Bulgaria .. 9d.	25 Roumania .. 9d.
25 Fr. Colonies .. 9d.	25 San Marino .. 9d.
25 Greece .. 9d.	10 Sudan .. 1/-

Post free with our famous "½d. Upwards" approvals.

CAPTAIN M. CAMPBELL & CO. (Dept. MM)
58, High Street, Watford, Herts.

FOREIGN STAMPS

100 diff. 1/-; 250 2/-; 500 — 3/6; 1,000 — 10/-; 1,000 mixed stamps 5/-.

50 diff. either Austria, Belgium, Denmark, Dutch, Brit. Colonials, China, Japan, Italy, Germany, Sweden or Czech., 1/-; 100 2/-; 200 4/-. List 1d. Hand, Rosebery Rd. Epsom.

THREE TRIANGULARS FREE

Valuable packet of magnificent giant pictorials, from **Monaco, Nicaragua (Volcano)** and **North Mongolia (Tannu Tuva)**. Send 3d. postage and ask for Approvals.

ROSTON (I), 106, St. Dunstan's Road, London W.6

FREE G.VI G.B. 10/-, now obsolete.

Send 3d. post, request approvals containing U.P.U.s., Weddings and latest commemoratives.

GODDARD, 29, ARCADE, BOSCOMBE, HANTS.



(Gifts inc. full-size Tweezers, etc.) — **WRIGHT'S STAMP SHOP — (M28) — CANTERBURY — Kent.**

"DOUBLE TRIANGLE PKT."
← FREE →

with 10 other stamps. Just send 2½d. postage and ask to see Special "MERCURY" Approvals.

Philip J. Dyke, 35, Buckleigh Ave., London S.W.20



NEW ISSUE PACKET FREE

A fine set of these large pictorial mint stamps sent by return of post.

Request our famous approvals and enclose 2½d. postage.
L. E. THOMPSON (MM), 2, Western Gardens, W.5

FREE 100 STAMPS ALL DIFFERENT

including Jet Bomber, Skymaster Plane, Railway Engine and other Fine Stamps to all applicants requesting Bargain Discount Approvals enclosing 4d. for postage, etc. (Without approvals 1/-).

A. HUGHES, 34, LOCHALINE STREET, LONDON W.6

U.P.U.s COST MONEY

but a really worthwhile packet of them will be sent FREE to applicants for my Approvals who enclose 2½d. postage.

D. J. Palmer (M11), Highwood Hill Camp, Mill Hill, N.W.7

BRITISH GUIANA SCARCE 5 DOLLARS

GREEN 1888/9 ISSUE, Catalogued 85/-. Selected pen cancelled copies at 2/6 each. Supply limited.

HILLIER — 10, ARTHUR ROAD — MARGATE

★ WORLD-WIDE PACKETS ★

Sample selection 1/- + 2½d. stamp for lists.

J. THOMPSON, 42, BOURNEMOUTH ROAD, BLACKPOOL

These New FALKLAND Is. & TRISTAN DA CUNHA FREE

Unused and Free (without obligation) to collectors asking to see our Famous Quality Approvals at right prices. Send 3d. to cover our postage and lists. If you wish, join "THE CODE STAMP CLUB." Sub. 1/-, you rec. Badge, Membership Card listing fine Gifts and approvals Monthly.

Stamp Collecting

Forming a King George VI Collection

By F. E. Metcalfe

LAST month I promised to tell how to set about forming a K.G. VI collection, and wrote that what I had to say would apply equally to the formation of any other kind of a collection. Let me remind you also that when there were relatively few stamps, some headway could be made with a general collection and one could gather enough stamps to enable one to feel that the collection was a representative one. But things have changed. One cannot keep up nowadays with all the stamps that have been and are being issued, so the best way to carry on our wonderful hobby is find some more restricted field.

The most popular group of stamps in the world are those of the Commonwealth of the present reign. They have got everything that a collector can possibly want. They have beauty; they can be obtained



easily; and they have a re-sale value higher in proportion than that of any other stamps, which is quite important when one is likely to spend more cash on one's collection

than one wants to throw away.

In an Australian stamp journal a writer recently suggested that the formation of a K.G. VI collection, in blocks of four, up to a top face value of 3d. would give a lot of pleasure, and even some profit. If we reduce the blocks to single stamps, we shall still have a nice little collection in the making, and its cost will be within the scope of the most hard-up school boy.

But let us consider a collection up to a face value of 1/-. Fifty odd current sets up to this value of the various countries in the Commonwealth can be obtained for about half-a-crown to four shillings each. There are many dealers selling K.G. VI stamps. Write to one who issues a price list of current stamps, and do not buy any obsolete stamps until all current ones have been obtained, for stamps are changing all the time and once they go obsolete up goes the price.

Some collectors prefer used, but taking all points into consideration I think mint stamps are the best for beginners to buy.

A catalogue will be needed, and there are two published at home that deal exclusively with K.G. VI issues. One is Gibbons, which has a paper back and is sold at 4/-, and the other the Commonwealth Catalogue at 7/6d. The latter is a bound book, and contains all the varieties, with diagrams, which will attract you as soon as you get interested in the art of stamp collecting.

As I explained last month, you will need a spring back album, with plain pages. K.G. VI albums are



published in which there are spaces for the stamps included in the range, but I am against the use of these, for even if you have a nice set of stamps to a shilling—and I hope that many will collect these stamps even if they cannot go as high as that—you will still have a lot of ugly blanks. If you have an album with plain pages, however, you can arrange your set to look something.



A good loose-leaf plain album can be obtained from about a guinea. Having obtained your album, and a few sets of stamps, you next need a pair of tweezers, a packet of good stamp mounts, and of course the catalogue.

A word about stamp mounts. We are assuming that you have decided to collect mint stamps. If one of these has a lot of pieces of mounts stuck on the back, it loses value. In fact many collectors to-day do not like stamps that have been mounted at all, but that is carrying the rage for condition too far. Foreign mounts are being offered at very high prices, and they are not worth the money. British mounts, at about 1/6d. a thousand, are good enough for anything, so buy these, and the shillings saved can be employed in obtaining more stamps.

Well, you have your album, and now wonder how to set about mounting your stamps. The page in front of you is blank, except for faint lines, which help you to arrange your stamps in an attractive pattern. Perhaps you are not a good writer and do not like to tackle the job of printing the name of the country at the top of the page. However, if you will get a good pen—not a ball pointed one—and practise on a few sheets of paper, you will be surprised how soon you will learn to



form decent letters. If you prefer to take an easier path, you can buy a booklet of gummed headings for about a shilling. These you can cut out and stick at the tops of the pages, to make quite a neat job.

Arrange the set in a nice pattern to your liking, but read your catalogue carefully to see if there are any stamps, as there are likely to be, that are not in your current set. If there are be sure to leave spaces for these, so that if and when you obtain them later on you will not need to re-arrange the stamps you have mounted. If any of the missing stamps are rare, and quite above your pocket, you can ignore them as far as leaving a space is concerned.

If you adopt the suggested method you will be really building up something that not only looks well, but something that will really appreciate in value. That being the case, when you spend a few shillings more than you feel you can afford to throw away, you will have the satisfaction of knowing that you are not really throwing your money away at all, a very different state of affairs from the old method of buying oddments that have practically no resale value.

After all, this is important, for a collector who really gets interested in his hobby spends more than he likes to throw away.



MONACO POPE TRIANGULAR FREE!

ABSOLUTELY FREE. If you ask to see a Selection of Windsor Stamps on Approval the Windsor Stamp Co. will send to YOU ABSOLUTELY FREE this Large Triangular New Issue. It comes from MONACO on the Mediterranean coast and portrays Pope Pius XII, and was issued to commemorate the 1951 Holy Year. IT IS YOURS ABSOLUTELY FREE. Just write for MONACO POPE TRIANGULAR FREE GIFT and ask to see a Selection of Windsor Stamps on Approval. Please enclose 2½d. stamp for postage to you. You are advised to write NOW.

WINDSOR STAMP CO. (Dept. M)
UCKFIELD, SUSSEX



FREE!

TO ALL
COLLECTORS
4 STAMPS OF
GOLD COAST
BARGAIN - 50 CHINA 1/3

Send 2½d. Postage

G. P. KEEF — WILLINGDON — EASTBOURNE

MYSTERY EXCHANGE PACKETS!

Exchange your "twicers" FREE from our guaranteed unsorted Free Exchange Packets which have circulated the World over. Different, profitable and interesting without payment. Details with 5 different NIGERIA also FREE with APPROVALS. ENCLOSE POSTAGE. Dealers Supplied. Overseas Agents Wanted.

ASTLEY & CO. (M)

103, CADMAN CRESCENT, WOLVERHAMPTON

FREE GIFT OF STAMPS

to every applicant for approval books. The GIFT contains 30 British Colonials including 8 K.G. VI mint—no Great Britain. Good discount is given and a list of 98 Gifts is sent. These can be chosen by you and vary in value according to the money sent for purchases. They include K.G. VI Silver Jubilees; ALL the Colonial Victory sets mint; and Foreign stamps. 3d. postage please.

C. A. RUSH, 38, Queen's Avenue, Whetstone, London N.20

FREE 2½d. MINT EDWARD VIII FREE

The Uncrowned King

This MINT elusive BRITISH stamp. FREE to all applicants who send 2½d. for postage and ask to see a selection of my "WORTH WHILE" approval sheets. No stamps sent abroad. Jos. H. Gaze, 10, Pimlico Road, CLITHEROE, Lancs.

NEW FALKLANDS FREE

Beautiful Colonials showing H.M.S. "Fitzroy" and Falkland Sheep given Free to genuine approval applicants. We pay postage. Special Clearance Parcels at 5/-, 10/-, £1. Northern Stamp Co., 8, Rowan Place, New Earswick, York

CHOOSE YOUR OWN FREE GIFT. Select a country from your album of which you have few or no stamps; send the name to me with 3d. stamp for postage requesting my discount approvals and a packet of stamps will be sent to fill the spaces absolutely free. John H. Abel (MCF), 53, Green Close, Sturminster Newton, Dorset

3,000 STAMPS FREE!! Send 2½d. for details of this marvellous gift & approvals. YEOMAN, 18, DEVON ROAD, HERSHAM, SURREY

For other Stamp Advertisements see also pages 88 and xvi.

PRINCE CHARLES

The first two stamps showing Prince Charles were issued in 1950 by New Zealand. I offer both of these fine large stamps, showing the young Prince with Princess Elizabeth, free to all applicants for approvals enclosing postage.

Mention the Meccano Magazine.

R. D. HARRISON, ROYDON, WARE

I DO NOT ADVERTISE Free gifts, but offer Service and Value. Approvals from ½d. upwards. Want Lists—Just state countries and S.G. Cat. Nos. Exchange your duplicates FREE. Details post free. A. DONNELLY (M), 1, ABINGDON ROAD, LUTON, BEDS.

GEM APPROVALS

Fine selection of Brilliant Mint Pictorial Stamps, sent Post-Free one way, on 10 days approval. List of books available included free and good discount given. These stamps represent good value and sell quickly—Send your application now to:—

GEM STAMP CO.

(Dept. M), 514, Fairfax Drive, Westcliff, Essex



FREE! This fine New Zealand issue is FREE to all asking for our Approvals and enclosing 3d. stamp. Write at once to:

FRANCIS CURTIS LTD. (MZ)
226, BAKER STREET, LONDON N.W.1

ILLNESS Owing to illness I shall be unable to forward approvals for some weeks.

N. JOHNSON, 19, HILLSIDE, SLOUGH

FREE 50 different incl. pictorials, value 5/-. Send 2½d. for discount approvals incl. pictorials at ½d. each. G. M. WALKER, 13, BROOM RD., HALE, CHESHIRE

FREE—STAMPS CATALOGUED 5/-
to applicants for ½d. approvals

COX, 17, STONELEIGH PARK ROAD, EWELL

SARAWAK Set FREE. LARGE MINT PICTORIALS. Please enclose 2½d. stamp. Request approvals. WATSON, 85, Larkswood Road, Chingford, London E.4

Stamp Gossip

By F. E. Metcalfe

AUSTRALIA IN THE NEWS

IT has never been the method of the Australian Post Office to issue a full set of ordinary stamps at one time, as is the practice of most countries, yet though sets have appeared piecemeal, as it were,



they still have fallen into categories. First we had the "kangaroos," or "roos" as Australians affectionately call them. When these were current few bothered to collect them mint, which is the reason why some cost so much to-day. The next type was the "King's Head," and while these, with so many shades and varieties to commend them, are very popular with philatelists, few would claim any artistic merit for the design.

Next we had the simple designs of the present reign. A great improvement, with the high values—"robes"—really handsome stamps. These were followed by several stamps with designs that did little credit to anyone. In fact I have heard the 2½d. value, S.G. 205, Com 38, described as the poorest stamp issued during the present reign. But now these overloaded designs are being replaced by something very much better. But what funny values, I can hear someone say. The 8½d. appeared on 14th August 1950, the 7½d. on 31st October 1951 and the 3½d. on 28th November 1951 and we are to have 4½d., 6½d., and 1/0½d. stamps as well as more usual values. Altogether they are forming up into a quite attractive set.

It must be remembered that the Australian Post Office really wants its stamps for postal use, and it cannot afford to issue expensive bi-coloured line engraved stamps of the type the colonies bring out to tempt collectors. Even so, the new stamps of Australia are proof that a country can produce stamps that are not costly, but are still attractive. Perhaps the writer of these notes is rather prejudiced, but he would affirm without hesitation, that the ordinary postage stamps of Australia and New Zealand are, taking all into consideration, the two most fitting sets in use to-day. But whatever will some people say about the Australian stamp illustrated?

It must be remembered that the Australian Post Office really wants its stamps for postal use, and it cannot afford to issue expensive bi-coloured line engraved stamps of the type the colonies bring out to tempt collectors. Even so, the new stamps of Australia are proof that a country can produce stamps that are not costly, but are still attractive.

Perhaps the writer of these notes is rather prejudiced, but he would affirm without hesitation, that the ordinary postage stamps of Australia and New Zealand are, taking all into consideration, the two most fitting sets in use to-day. But whatever will some people say about the Australian stamp illustrated?

SOMETHING NEW FROM AFRICA

Some weeks ago one of the stamp magazines published strange news indeed. It was to the effect that a British stamp had been overprinted for use in Southern Rhodesia. Sure enough, the story proved to be true. In due course some of the stamps arrived in England, and it was then found that it was our own postage due stamps that had been overprinted.

But the surprise didn't end there, for one of the stamps to be overprinted was the 4d. blue. While this particular stamp had been prepared for use at home, actually it had not come into use here when it was overprinted for the African territory, so we had the anomaly of a British stamp being used in another country before it was issued at home.

There is just one more interesting point about this set of stamps. Three of the six values were blue, with different shades, of course, and it will be an interesting

little puzzle to name the three shades correctly.

THE GERMAN "LIBERTY BELL" STAMP

In the November "M.M." the Western Germany "Liberty Bell" stamp was illustrated. With reference to this,



reader David Goodall, Manchester, has written as follows: "I have the 30p. stamp of the set and it came to me on a letter from the Western Sector of Berlin. The bell, which was given by the Western Allies to the people of Berlin, now hangs in the tower of the Town Hall of Schoeneberg (West Berlin). The inscription on it is in English and the part visible on the stamp reads 'New Birth of Freedom.'"

ADEN OVERPRINTS

It is claimed that collectors do not like overprinted stamps. It must be admitted that while some of these are very scarce, they do not seem to have as great an appeal as stamps of similar rarity that are not overprinted. Yet the stamps recently overprinted for Aden and the adjoining States are causing quite a bit of excitement, owing to the fact that various printings were used up and some interesting varieties have been found. First of all one sheet was found with the overprint inverted, and stamps from it are already changing hands at about £40 apiece. Then another sheet with no overprint at all was discovered, and stamps from this also are worth many pounds each.

I can hear someone say that if these stamps missed the overprint surely they merely remain normal stamps. But that isn't the case, for a special printing had been made and these stamps differ in shade from those in use before.

These are the highlights of the issue, for collectors with deep pockets, but there are varieties for everyone in the way of shades, and here is a tip. Try to pick up as many of these shades as can be found, for some of them will become scarce and will get into the catalogues. Those that actually become scarce should show a nice little profit later on.

THE N.Z. HEALTH STAMP YACHTS

This is not exactly the time of the year to discuss such a pastime as yachting in Great Britain, but several collectors are interested in the yachts that



appear on the 1951 New Zealand Healths. These are of what New Zealanders call the "Takapuna" class. They have a standard length of 12 ft. 6 in. and their championship racing rig comprises a mainsail and a spinnaker. There

is a crew of two, and in the championships there are conditions in regard to the ages and weights of the members of the crew. Such information should be very useful for writing-up purposes.

The stamps themselves form a nice addition to any collection. These Health stamps are becoming more popular every year, as sales show. Besides, buyers know that they are helping a good New Zealand cause.

From Our Readers

This page is reserved for articles from our readers. Contributions not exceeding 500 words in length are invited on any subject of which the writer has special knowledge or experience. These should be written neatly on one side of the paper only, and should be accompanied if possible by original photographs for use as illustrations. Articles published will be paid for. Statements in articles submitted are accepted as being sent in good faith, but the Editor takes no responsibility for their accuracy.

A WELSH BALANCE PIT

A photograph of the Lynton-Lynmouth Cliff Railway was reproduced in the "M.M." last August, and I thought readers would be interested in the accompanying picture of an old pithead at Talywain,

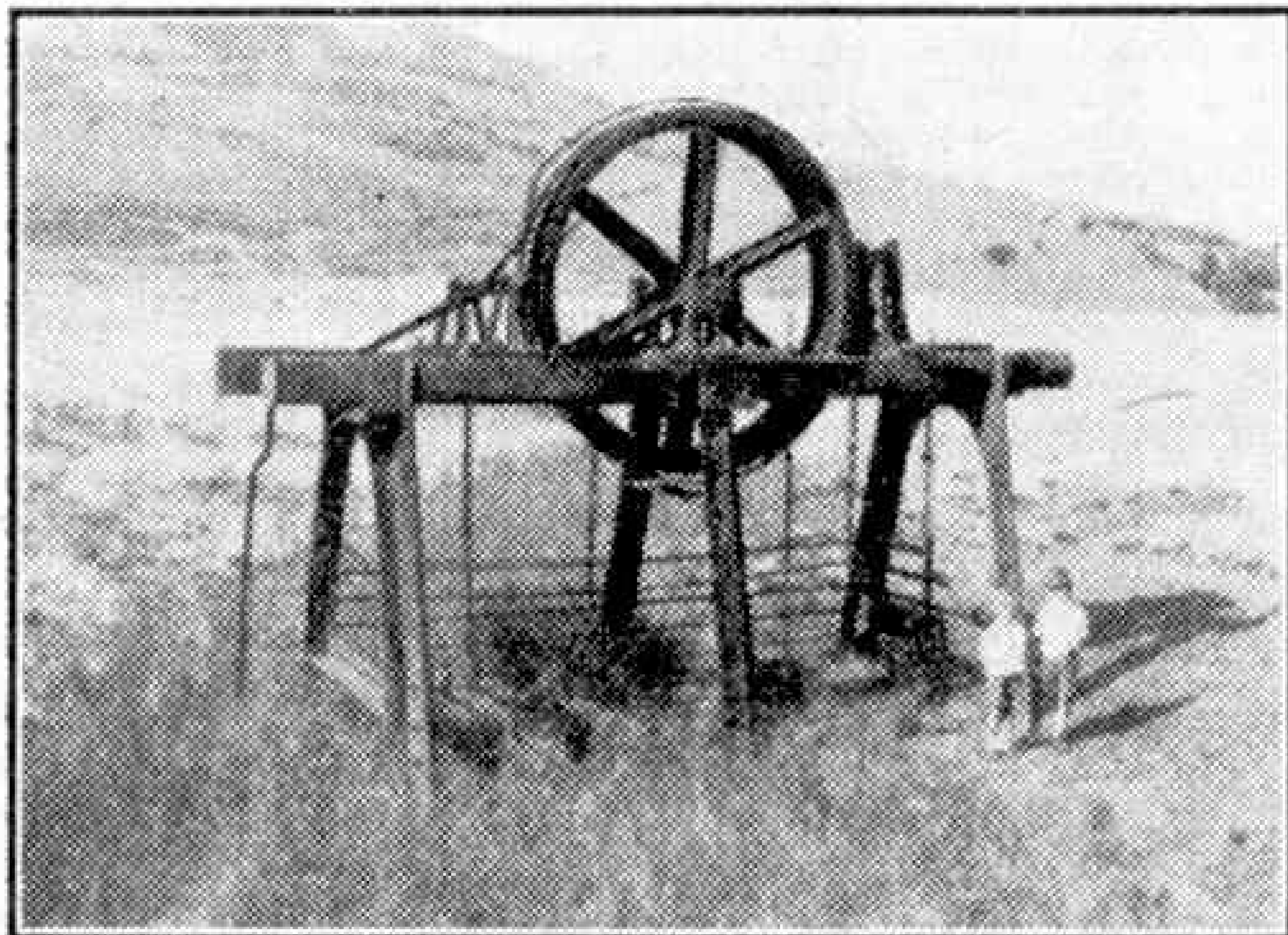

A balance pit at Talywain, Mon. Water poured into tanks beneath the cages causes each in turn to descend the shaft.

Monmouthshire, as many years ago its two cages were worked on the same principle.

Each cage was constructed with a ballast tank under it, and this was filled with water to cause it to move down the shaft. The mine was called a balance pit because the cage with the full tank went down and pulled up the other cage with a small tram of coal. The brake lever can be seen on the left of the frame-work.

The photograph, which includes myself and my younger brother, was taken by my father a few years ago.

HUGH WILLIS (Talywain).

AGILE PERFORMING GOAT

When I was on holiday in Madrid recently I witnessed a remarkable feat of agility and balance on the part of that notoriously agile creature, the goat. The owner, a full-blooded gypsy, had trained the animal to climb at a word of command to the top platform of a high stepladder. A further order caused him to feel his way gingerly to the tiny top of a 12 in. pinnacle on which he remained balanced until, on other words of command, he raised each foreleg in succession. Finally he dismounted and came down the steps to ground level.

The performance was given to the accompaniment of rhythmic beats on the gypsy's tambourine and was repeated at each street corner. It was received appreciatively by the Spaniards, who gave money freely to the gypsy collectors, a woman and two children.

The animal appeared to be well-kept and did not have to be forced to carry out its frequent performances.

R. S. RIDDELL (London N.20).

ANOTHER "GRIPFAST" ADVENTURE

In the "M.M." for November last reference was made in an article by Mr. Morrys Rodney to the

steamship "Stancliffe," now named "Gripfast," which was cut in two and reconstructed after being wrecked. This belongs to my father's shipping company and late last year she had another tragic moment.

In a terrific storm the "Gripfast" was steaming up the North East Coast when distress signals were seen. They came from a very small ship, the "Pandora," which was sinking. The "Gripfast" immediately went to the rescue, and from her Captain Bainbridge had got 10 lines over the "Pandora" when a great wave crashed the two vessels together, damaging the "Gripfast's" propeller severely. She was herself moving rapidly on to the rocks when a tug caught her with a few lines and pulled her to safety.

G. V. HASLAM (Humshaugh).

THE BRAY HEAD AERIAL ROPEWAY

Tourists and sightseers visiting Bray, Co. Wicklow, in 1952 will climb the 761-ft. Bray head without the customary tired and sore feet, for an aerial ropeway has been constructed that will enable them to climb easily to the summit to see the panorama from it. This includes the Irish Sea, the Mourne, Carlingford and Welsh mountains, the Wicklow hills, and part of the great central plain of Ireland.

The ropeway will cater for 600 tourists an hour when in full swing. There will be 14 cars, each carrying two persons, and they will climb the hill at 50-yd. intervals. Their speed should be about 20 m.p.h. on an average gradient of about 1 in 15. Seven pylons support the cable, and an automatic "tension weight" adjusts the rope to allow for the number of cars actually on the system.

LIAM CLARE (Bray).



A performing goat shows his skill and sense of balance in Madrid. Photograph by R. S. Riddell, London N.20.

Competitions! Open To All Readers

Prize-winning entries in "M.M." competitions become the property of Meccano Ltd. Unsuccessful entries in photographic, drawing and similar contests will be returned if suitable stamped addressed envelopes or wrappers are enclosed with them.

Can You Recognise These Engine Shadows?

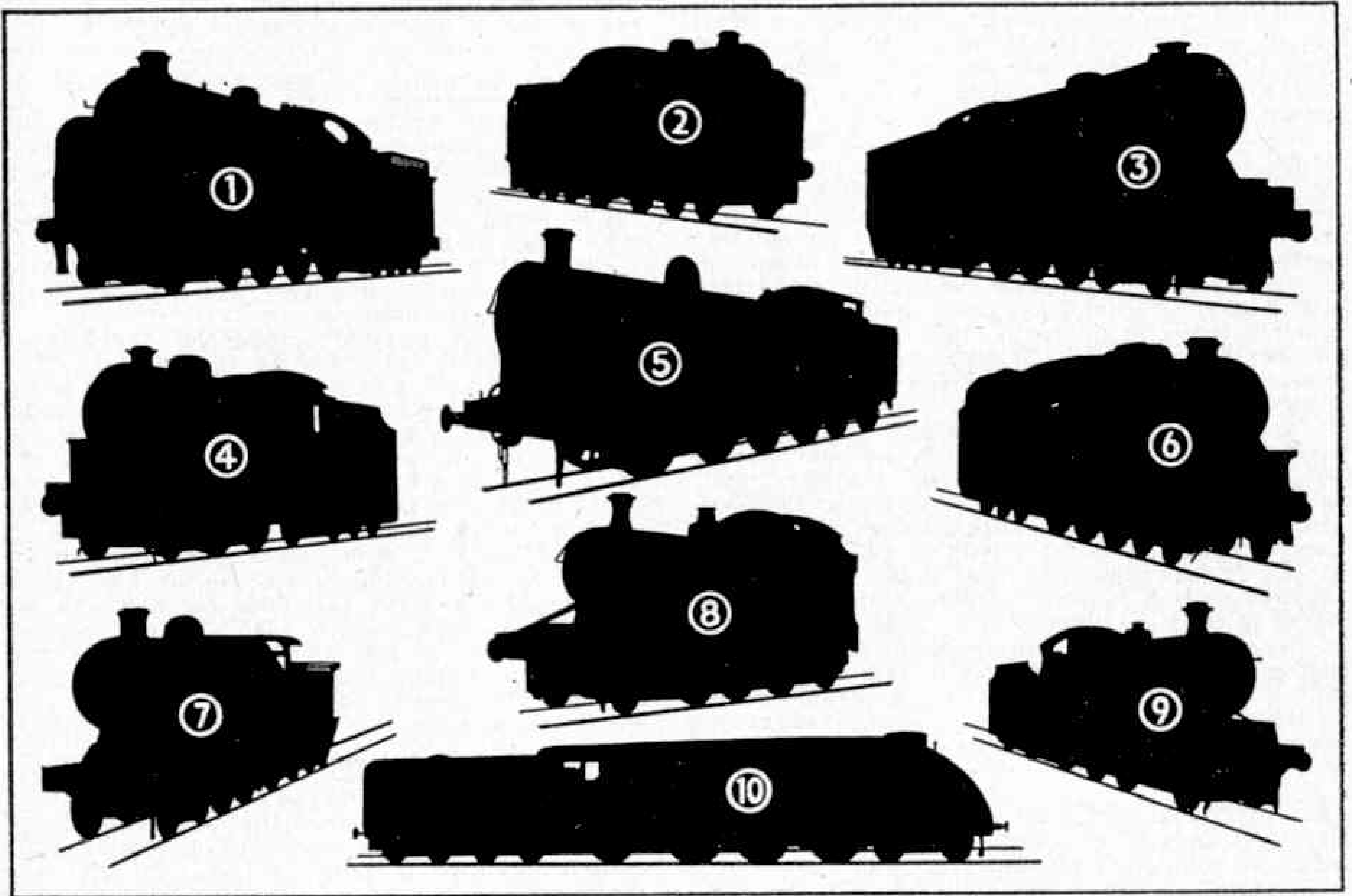

The illustration above shows ten "Locomotive Shadows." Some of these silhouettes will be recognised easily. Others may require more careful examination, but keen "M.M." readers should manage to identify the locomotive classes represented.

When this has been done entrants for this competition should make out a numbered list, giving the class, wheel arrangement and former owning company of each engine, and this should be posted to "February Locomotive Shadow Contest, Meccano Magazine, Binns Road, Liverpool 13." Every

Competitor should take care to put his name and address on each sheet of his entry.

As usual, the competition will be divided into two sections, for Home and Overseas readers respectively. In each of these there will be prizes of 21/-, 15/- and 10/6 for the best entries in order of merit, with Consolation Prizes for other good efforts. The judges will take neatness and originality into account in the event of a tie for any prize.

Closing dates: Home Section, 31st March; Overseas, 30th June.

"Go As You Please" Drawing Contest

This is a drawing competition in which every entrant can choose his own subject, and in which colour is not required. Entrants are simply asked to submit drawings, either in pencil or in pen and ink, of some scene or subject they feel they would like to reproduce on paper. On the back of his entry the competitor must write his name and address, with a short note or title stating exactly what the drawing represents.

There will be four sections altogether, two for Home readers and two for those Overseas, and in each case there will be Senior and Junior sections for readers aged 15 and over and for those under 15. In each section prizes of 21/-, 15/- and 10/6 will be awarded for the best entries in order of merit, with consolation prizes for other good efforts. Entries should be addressed to "February Drawing Contest, Meccano

Magazine, Binns Road, Liverpool 13." Closing dates: Home Section, 31st March; Overseas, 30th June.

February Photographic Contest

The second of our 1952 series of photographic contests is a general one in which we invite readers to submit prints of any subject. Each competitor may submit only one photograph, which must have been taken by him, and on the back of his print must be stated exactly what the photograph represents.

The competition will be in two sections, A for readers aged 16 and over, and B for those under 16. Each competitor must state in which section his photograph is entered. There will be separate overseas sections, and in each section prizes of 21/-, 15/- and 10/6 will be awarded. Entries should be addressed: "February Photographic Contest, Meccano Magazine, Binns Road, Liverpool 13." Closing dates: Home Section 29th February; Overseas Section, 31st May.

A Shining Canadian Arch—(Continued from page 51)

section, 65 ft. in length, weighed only $6\frac{1}{2}$ tons, and because of the remarkable lightness of the bridge members it was possible to make use of a cableway instead of derricks, travelling along the bridge as it was built outward from the banks, to place them in position. The cableway used had a span of 516 ft. and was capable of carrying loads up to 7 tons. The cable itself was a wire rope $1\frac{3}{8}$ in. in diameter, stretched between the tops of towers on the two sides of the river. To support the arch ribs of the bridge as these were extended out over the river, tieback wires, $1\frac{1}{2}$ in. in diameter, two at each end, were passed back over the towers and anchored into the rock. The wire ropes were designed to carry a load of nearly 45 tons.

The first step in erecting the arch was the placing of the four haunch sections of the ribs, which were held in place on the concrete abutments, built on each side of the river, by 14 anchor bolts each of which was 2 in. in diameter. There were two of these sections on each side, and when they were in position the lattice girder K-system bracing between them was inserted. Successive sections were lowered into position from the cableway, tied back and spliced on to the previously erected sections, and this continued until the arch was completed, with bracing between the two ribs.

The next step was to erect the vertical posts on the arch ribs. These posts are 20 ft. apart, and support the floor of the bridge. The actual roadway, 24 ft. wide, consists of a concrete slab 8 in. in thickness that was cast in position, with a bituminous wearing surface $2\frac{1}{2}$ in. thick laid on top of it. On each side is a 4 ft. sidewalk. This was made with pre-cast concrete units 5 ft. long, varying in thickness from $6\frac{1}{2}$ in. at the outer edge to $5\frac{1}{2}$ in. near the curb.

There are two ornamental pylons at the south end of the bridge, forming as it were an entrance to it. These have fluted shafts supporting globes of the world in cast aluminium, which at night are illuminated by concealed lights in the pedestals.

Making Stamps in America—(Continued from page 68)

envelopes are nearly 2,000 million, the sale value of which is more than 75 million dollars.

Stamped envelopes are, as provided by law, manufactured for the Department under private contract. For the production of the vast quantity of stamped envelopes required yearly, an extensive plant filled with modern specialised machinery is maintained, with a force of approximately 1,000 trained employees. The largest number of stamped envelopes manufactured in a single day was 19,168,000 on 29th June 1932, when the envelope factory was working at full speed to produce a large quantity of 3c. envelopes.

Stamped envelopes are issued in many sizes and styles to meet the various requirements of the public. Envelopes with distinctive red, white and blue borders have been provided for air mail letters. The coloured border enables postal employees to detect airmail letters easily when mixed with other mail.

The World's Tallest Statue—(Continued from page 73)

again as the Nelson Column in Trafalgar Square.

"America's permanent Leading Lady," as the statue has been aptly called, has thumbs 12 ft. round, and her finger nails are 13 in. long. The length of her hands is 16 ft. 6 in., and her nose measures 4 ft. 6 in. Her index fingers are just 8 ft. long.

Inside the figure are elevators and stairways to the head, and further stairways lead to the torch. A balustrade also surrounds the pedestal, and from this position extensive views of the New York waterfront can be obtained. The pedestal itself, 90ft. high and made of concrete, is one of the biggest monoliths ever raised. Each side of the base measures 62 ft. at the foot and 40 ft. at the top.

In every way this famous monument surpasses

everything else of the same kind in the world. M. Bartholdi is stated to have got his idea for such a statue from the celebrated Colossus of Rhodes, erected in 280 B.C. in honour of Apollo the Sun God, and demolished by an earthquake in 224 B.C.

The Statue of Liberty is an artistic creation, too, notable for its pleasing design as well as for its huge dimensions. One of the most memorable sights of the New World is the view of New York at night-time, from ships approaching the harbour. The floodlit Statue, with its flaming Torch of Freedom, then presents an unforgettable picture against the background of flickering skyscraper lights.

New Meccano Model—(Continued from page 83)

Cranks pivoted on $1\frac{1}{2}$ " Rods mounted in the rails. The Cranks are connected by a Spring 21, and a Fishplate bolted to each Crank clips over one of the truck axles.

The model is completed by adding the hopper roof, which is made from three $4\frac{1}{2}$ " \times $2\frac{1}{2}$ " Flexible Plates, a $5\frac{1}{2}$ " \times $1\frac{1}{2}$ " and a $2\frac{1}{2}$ " \times $1\frac{1}{2}$ " Flexible Plate. These Plates are bolted to $5\frac{1}{2}$ " Strips attached to the hopper by Angle Brackets.

Parts required to build Locomotive Coaling Plan 4 of No. 1; 18 of No. 2; 6 of No. 3; 2 of No. 4; 12 of No. 5; 4 of No. 6a; 8 of No. 8; 10 of No. 10; 3 of No. 11; 16 of No. 12; 3 of No. 12a; 4 of No. 12c; 1 of No. 13; 1 of No. 15; 1 of No. 15a; 1 of No. 15b; 4 of No. 18a; 1 of No. 19h; 4 of No. 20b; 2 of No. 22; 1 of No. 24; 1 of No. 26; 1 of No. 32; 6 of No. 35; 166 of No. 37; 16 of No. 37a; 12 of No. 38; 1 of No. 40; 1 of No. 43; 2 of No. 45; 2 of No. 48; 1 of No. 48a; 2 of No. 48b; 1 of No. 51; 2 of No. 52; 3 of No. 53; 2 of No. 54; 6 of No. 59; 2 of No. 62; 1 of No. 63; 1 of No. 90; 2 of No. 111; 4 of No. 111c; 1 of No. 115; 2 of No. 126; 4 of No. 126a; 1 of No. 147b; 2 of No. 163; 2 of No. 186a; 6 of No. 188; 6 of No. 189; 8 of No. 190; 2 of No. 191; 4 of No. 192; 1 of No. 197; 1 of No. 198; 2 of No. 200; 2 of No. 214.

Model-Building Made Easy—(Continued from page 80)

give a slower speed in reverse.

A simple gear arrangement that gives two forward speeds and a reverse drive and which is suitable for small model cars, is shown in Fig. 2. In this case the gears are held in a casing formed by bolting two $2\frac{1}{2}$ " \times 1 " Double Angle Strips together with two $2\frac{1}{2}$ " Angle Girders to a $2\frac{1}{2}$ " Flat Girder. The shaft driven by the Motor is a 4" Rod 1 slideable in its bearings and it carries a $\frac{1}{2}$ " Pinion 2 and a $\frac{3}{4}$ " Pinion 3.

The reversing Pinion 4 is a $\frac{1}{2}$ " \times $\frac{1}{2}$ " Pinion free on a $1\frac{1}{2}$ " Rod fixed in a Collar. The Collar is locked to one of the Angle Girders by a $\frac{1}{2}$ " Bolt, on the shank of which a second Collar and two Washers are placed for spacing purposes.

The sliding shaft is controlled by a $2\frac{1}{2}$ " Strip lock-nutted to the side of the gear-box and fitted with a $\frac{3}{8}$ " Bolt, the head of which engages the bosses of the Pinions 2 and 3.

The driven shaft is a $3\frac{1}{2}$ " Rod passed through the arms of the second Double Angle Strip and it carries a $\frac{1}{2}$ " Pinion 5 and $\frac{3}{4}$ " Pinion 6.

Movement of the lever to the right brings Pinions 3 and 5 into engagement to give top gear. When the lever is central Pinions 2 and 6 are meshed to give bottom gear. Movement of the lever to the left causes Pinion 3 to engage the reversing Pinion 4 and so produce the reverse drive. Pinion 4 is constantly meshed with Pinion 6.

Giant Road Trailer—(Continued from page 55)

or winched up a ramp on to it, after which the swan-necks are attached. The hydraulic equipment then lifts the main frame and its load sufficiently high to give travelling clearance.

When transformers or similar bulky objects are being carried the side members of the frame are fitted at such a distance apart that they are along the side of the load, which is carried as if in a sedan chair.

Fireside Fun

"It's easy to see Jones is a gardener."
 "Why?"
 "He's got a daughter who is a shrinking violet and a son who is a budding genius, and both are blooming nuisances."



"Gosh, Bill! I wish I had my pick here."
 "I'd rather have my shovel."

"Dad, I put a stick of dynamite under the teacher's chair."
 "You did? Then you can just go back to school and apologise."
 "What school, dad?"

"I've just had a three-week holiday in France, where I learned to speak French."
 "In three weeks? I can't understand that."
 "Neither could the French."

"Teachers have no sense of fairness, have they?"
 "What have they been doing to you now?"
 "Well Mr. Brown is always telling us to be manly and never to hit anybody smaller than we are."
 "Well? What about it?"
 "Today, just because I happened to tread on his foot, he turned round and boxed my ears."



"Ever been in the Zoo, boy?"
 "No, sir."
 "You should go there. You'd enjoy watching the turtles zip by."

BRAIN TEASERS FIND THE MISSING WORD

There are seven lines and seven columns in the accompanying square, but clues are given only to six of the words to be placed in the lines. With all seven words in position the diagonals will spell the names of a musical instrument and a household necessity.

1						
2						
3						
4						
5						
6						
7						

Filling in the six words indicated by the clues should give those in the diagonals and two letters of the word in the blank line. Can you find a word for this line and provide a clue for it? The Editor will give a prize of 2/6 to the sender of the best effort that reaches him by 29th February.

The six clues are: 1, Travels for sight-seeing; 2, Goods on the way; 3, Inhuman; 4, Is worn; 6, Removes dirt; 7, Beseech.

A PROVERBIAL TERROR

"When at last it chased some of the boys into a narrow street I met it with a pitchfork in the hope that I could save some of them when in extremity, but the worst happened."

This sounds like a terrible tale of a mad bull's career, and I do not know what the "worst" turned out to be; but I did find in the sentence shown above the words of a well-known proverb very nicely hidden. Each of the words is complete and they appear in correct order. What is the proverb?



"Mummy sent me to ask you for a tape measure, please."
 "Yes, dear. How long does she want it?"
 "I think she wants to keep it."

SOLUTIONS TO LAST MONTH'S PUZZLES

The formidable division sum in letters works out to the following division in numbers:

$$131101 \overline{)2437167590} (18590$$

$$\begin{array}{r} 131101 \\ 1126157 \\ \hline 1048808 \end{array}$$

$$\begin{array}{r} 773495 \\ 655505 \\ \hline \end{array}$$

$$\begin{array}{r} 1179909 \\ 1179909 \\ \hline \end{array}$$

The words of the pyramid of our second puzzle were A, AN, WAN, WANE, DEWAN and WARNED.



YOU can make models like this

With one of

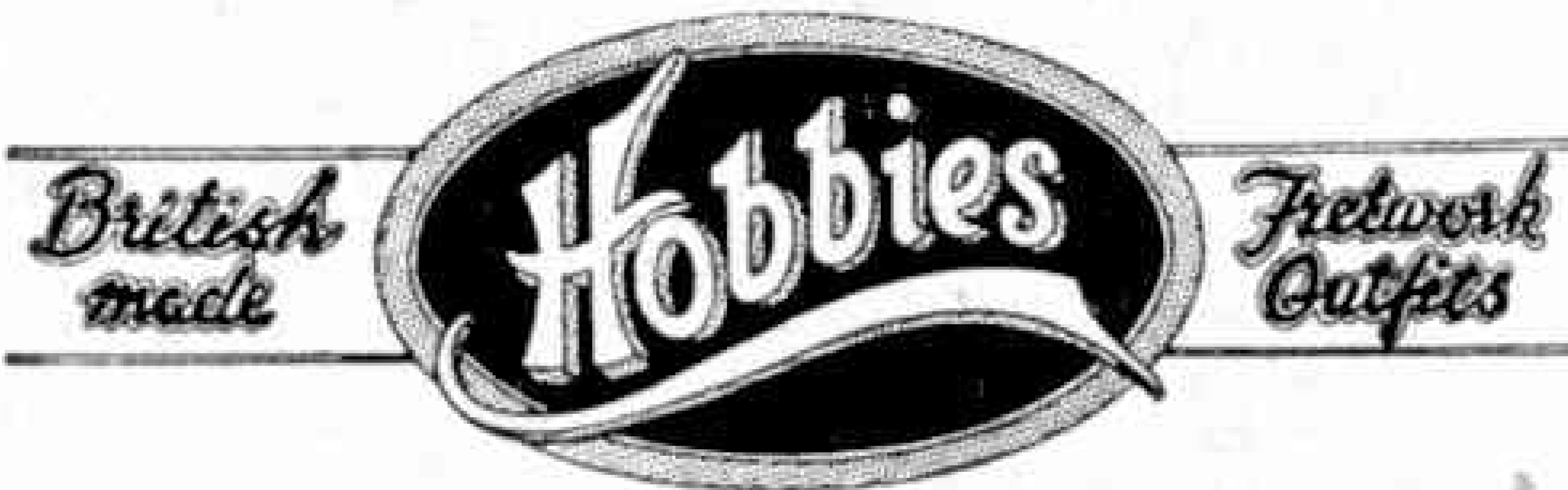

There are hundreds of things you can make, from a Pipe Rack to a St. Paul's Cathedral model. Complete kits of materials, full-size plans and instructions. All you need is a set of Hobbies Tools. From 11/6 to 62/6, each one complete. A fascinating pleasure for your spare time.

Get you outfit NOW. A popular one is the A1 at 34/6. It will last a lifetime.

Obtainable at any Hobbies Branch, and all leading stores and ironmongers. Or post free from Hobbies Ltd., Dept. 96, Dereham, Norfolk

Free illustrated leaflets on request

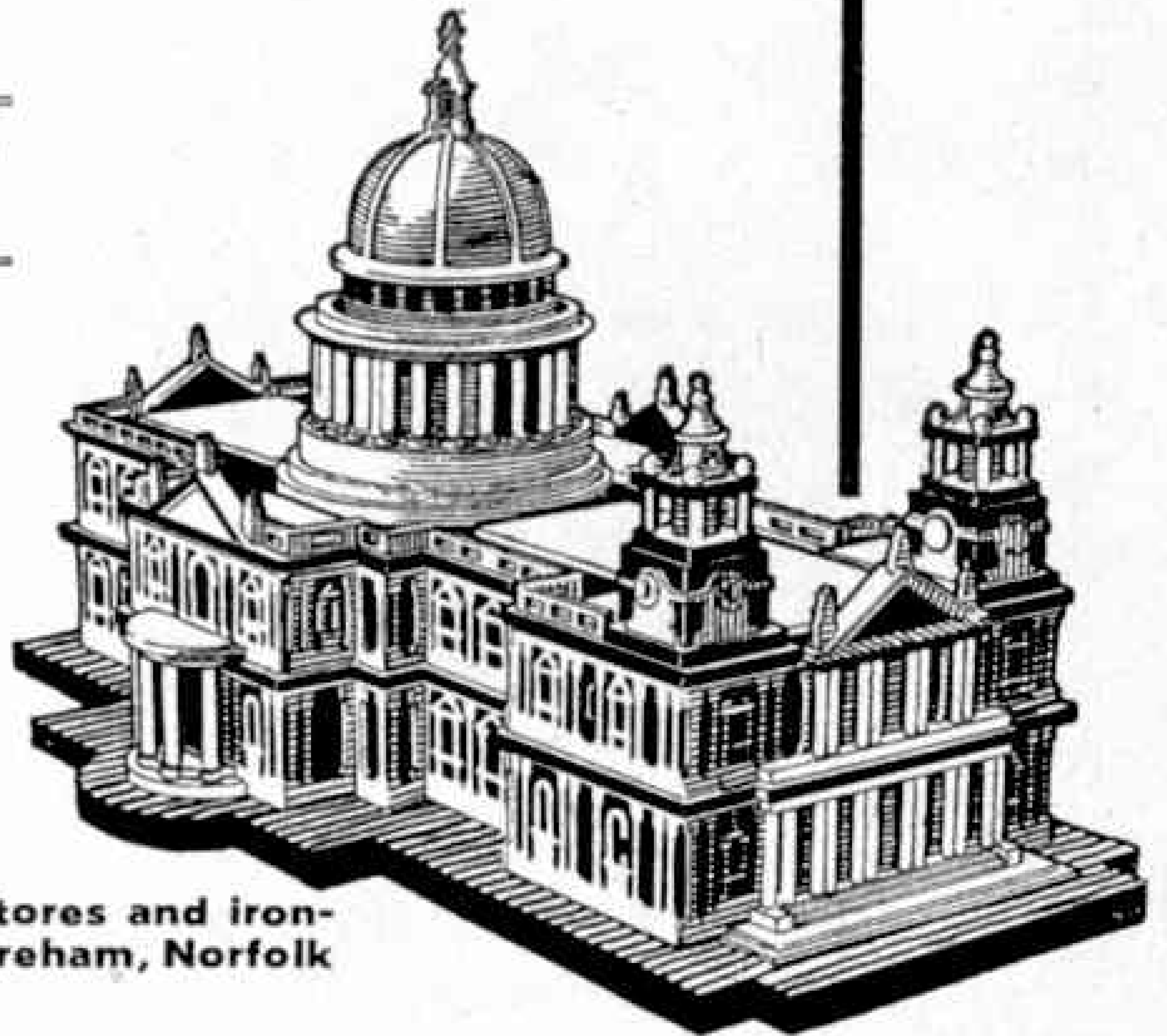

"THE ERG CATALOGUE AND MANUAL"

Price 3/6 (by post 3/10)

The finest guide to the finest range of model railway parts and accessories for all who are interested in 00 gauge.

"CARDBOARD ROLLING STOCK AND HOW TO BUILD IT"

Price 2/6 (by post 2/9)

The record-breaking text book giving clear instructions, with diagrams and photographs, showing how easily a perfect and full detailed wagon or van can be built.

"THE STUDY OF THE MODEL RAILWAY"

Price 3/6 (by post 3/9)

A really fascinating book that is a pleasure to read, and at the same time teaches many of those finer points of railway modelling that are not to be found in any other text book, and can only be gathered by years of experience.



The Leading 00 Trade Supply Firm
529 ROUMELIA LANE
BOSCOMBE
BOURNEMOUTH

ASTRA

RETAIL PRICE

7/9

Purchase Tax 1/9 Extra



RETAIL PRICE

7/9

Purchase Tax 1/9 Extra

WORKING MODEL TRAFFIC SIGNAL

Unbreakable plastic coloured lenses. 4½ volt flat battery can be housed in the base.

Model approx. 6" high.

FROM ALL GOOD TOYSHOPS

Sole Patentees and Manufacturers:

ASTRA PHAROS LTD.

LANDOR WORKS, ASKEW ROAD, LONDON W.12

THE FUTURE IS YOURS PREPARE FOR IT NOW

Maximum production, on which the life of the nation rests, depends on high technical skill. This gives marvellous opportunities to young men who have acquired such knowledge and efficiency as that contained in an I.C.S. Course of Instruction.

THE DEMAND FOR WELL-TRAINED MEN IS URGENT AND UNLIMITED — BUT THERE IS NO WORTH-WHILE PLACE FOR THE UNTRAINED

If you need technical training, our advice on any matter concerning your work and your career is yours for the asking—free and without obligation. Let us send you full information regarding the subject in which you are specially interested. DON'T DELAY. Make ACTION your watchword.

The successful man DOES to-day what the failure INTENDS doing to-morrow. Write to us TO-DAY.

Generous Discount granted to members of H.M. Forces

The I.C.S. offer Courses of Instruction in a wide range of subjects, including:

- | | |
|--------------------------|--------------------------|
| Accountancy | Illumination Engineering |
| Advertising | Journalism (Free Lance) |
| Copy Writing | Machine Designing |
| Advertising Management | Maintenance Engineering |
| Air and Vacuum Brakes | Marine Engineering |
| Air-Conditioning | Mechanical Drawing |
| Arable Farming | Mechanical Engineering |
| Architecture | Mine Surveying |
| Boiler Engineering | Mining Electrical |
| Book-keeping | Motor Engineering |
| Building | Motor Mechanic |
| Business Training | Plastics |
| Business Management | Production Engineering |
| Carpentry and Joinery | Quantity Surveying |
| Chemical Engineering | Radio Engineering |
| Chemistry, Org. & Inorg. | Radio Service Eng. |
| Civil Engineering | Railroad Engineering |
| Clerk of Works | Refrigeration |
| Coal Mining | Salesmanship |
| Commercial Art | Sales Management |
| Concrete Engineering | Sanitary Engineering |
| Diesel Engineering | Sheet-Metal Work |
| Draughtsmanship | Short-Story Writing |
| Drawing Office Practice | Steam Engineering |
| Electrical Engineering | Structural Steelwork |
| Eng. Shop Practice | Surveying |
| Fire Engineering | Telegraph Engineering |
| Foremanship | Television Technology |
| Heating and Ventilation | Toolmaking |
| Horticulturist | Welding, Gas and Elec. |
| Hydraulic Engineering | Woodworking Drawing |
| Hydro-Electric | Works Engineering |
| | Works Management |

And most of the Technical, Professional, Commercial, Educational and Civil Service Exams., also for General Certificate of Education.

(Examination students are coached till successful.)

----- **YOU MAY USE THIS COUPON** -----
(Penny stamp on unsealed envelope)

INTERNATIONAL CORRESPONDENCE SCHOOLS LTD.
Dept. 218, International Buildings, Kingsway, London W.C.2

Please send booklet on subject.....

Name..... Age.....

(BLOCK LETTERS PLEASE)

Address.....



RAWLPLUG PRODUCTS

INDISPENSABLE
IN THE WORKSHOP
HANDY IN THE HOME



THE RAWLPLUG POPULAR OUTFIT

Larger sizes are obtainable.

Whatever your fixing problems, there's a Rawlplug Device that will solve it for you—easily and quickly. Rawlplugs make neat and absolutely firm fixings in any material from brick or tile to stone or slate, with a size for every screw from No. 3 up to $\frac{3}{8}$ " coach screws. Rawlplug Tools are easy to use and ensure a perfect hole without damage to surrounding surfaces. Other Rawlplug Devices include Rawlbolts for heavy duty fixings, Rawlanchors and Toggle Bolts for thin or hollow materials and Rawlclips for instant fixing of conduits and cables to girders—a device in fact for every need.

SOLDERING IRONS

MAKES SOLDERING CERTAIN AND SIMPLE



This is a guaranteed electric tool which will pay for itself many times over by repairing and giving longer life to metal household goods. In the workshop it is indispensable. Supplied with Standard bit, Hatchet or Pencil bit.

Voltages 100/110, 200/220, 230/250. Universal AC/DC.

IRON CEMENT

Rawlplug Iron Cement hardens very quickly and only needs mixing with water. It will repair Water and Gas pipes, Radiators, Cisterns, Buckets, Kettles, Saucepans, Stoves, Kitchen Utensils, etc., etc.



HEATLESS SOLDER



No iron is needed with Rawlplug Heatless Solder which is in paste form and dries in a few minutes. It is very useful for quick repairs to metalwork, but is not suitable for wireless or electrical connections.

DUROFIX



B410

The indispensable adhesive for instant use on crockery, glass, wood, metal, celluloid and the thousand and one things handled by the hobbies enthusiast. Instant drying, insulating, waterproof and heatproof. Durofix is grand for repairs to electrical, sports and leather goods.

PLASTIC WOOD

APPLIED LIKE PUTTY,
DRIES LIKE WOOD



Can be cut, planed, polished and painted like wood. Will take nails and screws like wood. It does not blister, crack or decay. Rawlplug Plastic Wood is actually the best quality product of its kind on the market.

THE RAWLPLUG COMPANY LIMITED
CROMWELL ROAD · LONDON S.W.7

HIGHSTONE UTILITIES

Meters. 15 v., 2½ in., m/c, 9/6; 150 v., 2 in., m/c, 10/-; 3.5 amp., 2 in. T.C., 5/-; 4 amp., 2½ in. T.C., in case with switch, 7/6; Meters. Units containing 2 500 microamp. movements, 6/-, post 8d. All meters post extra.

Bell Transformers. These guaranteed transformers work from any A.C. Mains, giving 3, 5, or 8 volts output at 1 amp., operate bulb, buzzer or bell. Will supply light in bedroom or larder, etc. Price 8/9, post 6d. BELLS, 6/-.

Ex-R.A.F. 2-valve (2-volt) Microphone Amplifiers as used in plane inter-com., in self-contained metal case; can be used to make up a deaf aid outfit, intercommunication system, or with crystal set, complete with valves and fitting instructions, 20/-, post 1/8. Ditto, less valves, 10/-.

Hand Microphones, with switch in handle, and lead, 4/-.

Similar instrument, moving coil, 7/6, post 6d.

Mike Buttons (carbon) 2/-. **Moving Coil, 4/6; Transformers, 5/-.** All post 4d. each.

Soldering Irons. Our new streamlined Iron is fitted with a curved pencil bit; 200/250 v. 50 watts, 10/-.

Standard Iron with adjustable bit, 200/250 v., 60 watts, 12/-.

Heavy Duty Iron, 150 watts, 15/6, all post 6d.

Crystal Sets. Our latest Model is a real radio receiver, fitted with a permanent crystal detector, 10/6, post 6d. De Luxe Receiver in polished cabinet, 18/6, post 1/-. Spare Permanent Detectors, 2/- each. When ordered separately, 2/6, with clips and screws, 2/10, post 3d. Headphones, brand new, S. G. Brown, G.E.C., etc., 15/-, 23/-, and super-sensitive, 30/-, post 8d. **New Headphones, 10/-.** Balanced armature type (very sensitive), 12/6. Both post 8d. **New Single Earpieces, 3/6.** Bal. armature type, 4/6; ex-R.A.F. earpiece, 2/-, post 4d. **Headphones,** in good order, 5/6 (better quality), 7/6, all post 8d.

Letters only. Money refunded if not completely satisfied.

58, New Wanstead, London E.11

Illustrated List sent on request with 1½d. stamp and S.A.E.

Micromodels

TRADE MARK

OIL WELL CRACKING PLANT & MODEL TANKER

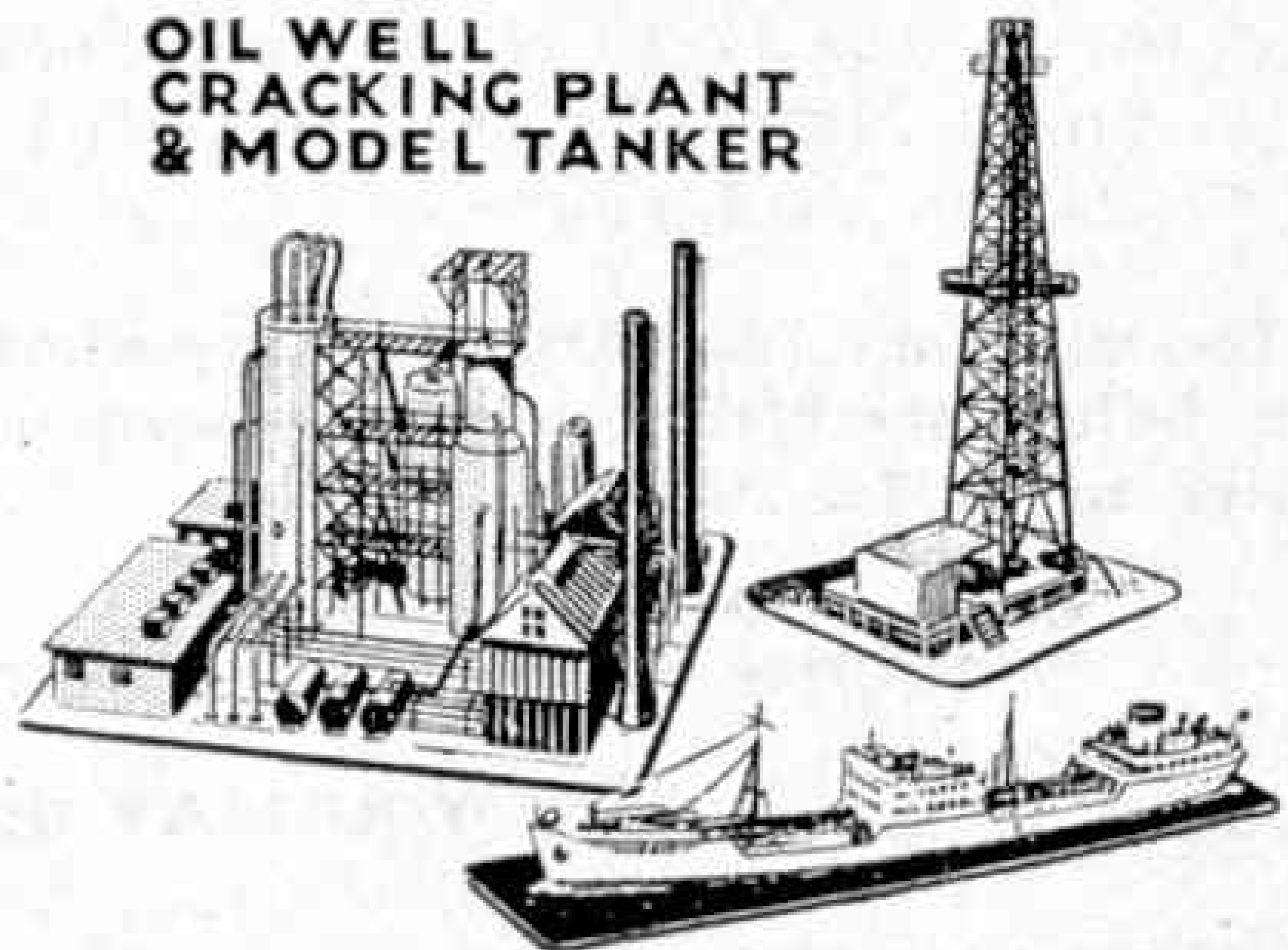

BUILDING miniature replicas of beautiful Mechanical, Architectural, Industrial and Maritime Subjects is a serious hobby. Printed on special cards, the units are cut and shaped to form perfect three-dimensional volumetric models authentic in every detail. They cost but pence, but often sell for guineas. Send stamped addressed envelope for Illustrated Descriptive Catalogue

MICROMODELS LTD.
3(MM). Racquet Court, London E.C.4

SHIPS
GALLEONS
LOCOS
HISTORIC &
ARCHITECTURAL
ENGINEERING
MOVING
TOYS
ETC.

MID-CENTURY MARVELS SEE HOW THEY WORK!

MIRACLES OF INVENTION AND DISCOVERY

SUPERB FULLY-ILLUSTRATED WONDER BOOK — YOURS AT

AMAZING PRIVILEGE PRICE!

ACT NOW! Fill in Reservation Form. Post in 1½d. stamped, unsealed envelope to Dept. X.V.A., The People's Home Library, 5, Dryden Street, London W.C.2.

Own the book every modern boy wants! Exciting! Fascinating! 320 fact-packed pages, over 200 pictures, reveal the inside story of to-day's wonder machines and split-second processes. Learn the full "how" and "why" of jet planes, invisible rays, submarines, radio and television, high-speed transport, the automatic telephone, etc., etc. See, step by step, how "talkies" are made and shown—how a daily newspaper is printed—how plastics are made and used, etc. Order NOW! Satisfaction or money back guaranteed. Durable Bookcloth; **ONLY 8/6**, inc. postage, etc.



SEND NO MONEY NOW POST FORM AT ONCE!

Reserve for me "MIRACLES OF INVENTION AND DISCOVERY" and send my Invoice and Certificate which entitles me to special privilege price.

NAME
(Use Block Letters.)
Full Postal
ADDRESS

Offer open in U.K. and Eire only. Closes Feb. 29.

X.V.A./T.M.I. Feb. 52.

OWNERS OF PRE-WAR HORNBY DUBLO TRAINS LOOK! GOOD NEWS

The flat type of spring coupling of your pre-war Hornby-Dublo Locomotives and Rolling Stock can now be replaced by the PECO SIMPLEX AUTO COUPLER, which is similar to the excellent coupling now fitted. PECO Couplings are obtainable from all good class Model Shops and supplied two in a carton, complete with mounting brackets and fully detailed fitting instructions.

If in difficulty, or you have any Railway Modelling problems, you are invited to write direct to the PECO Technical Advice Bureau, address as below, for free information and literature. Complete Catalogue, 1/3.

Read the NEW Railway Modeller, 24 large-sized pages (excluding ads.), full of interesting constructional articles, 1/6 monthly. Specimen copy 1/8 direct.

THE PRITCHARD PATENT PRODUCT CO. LTD. PECOWAY, STATION ROAD, SEATON, DEVON

LOTT'S Chemistry

Convert your chemistry set to a student's laboratory by easy stages.

Supplies of spare apparatus and chemicals are now available.

Also Lott's Stone Puzzle together with free book of 105 problems.

Ask to see them at your dealer or write to the manufacturers for current price list, enclosing stamped addressed envelope 1½d.

A SMALL SELECTION FROM OUR LIST

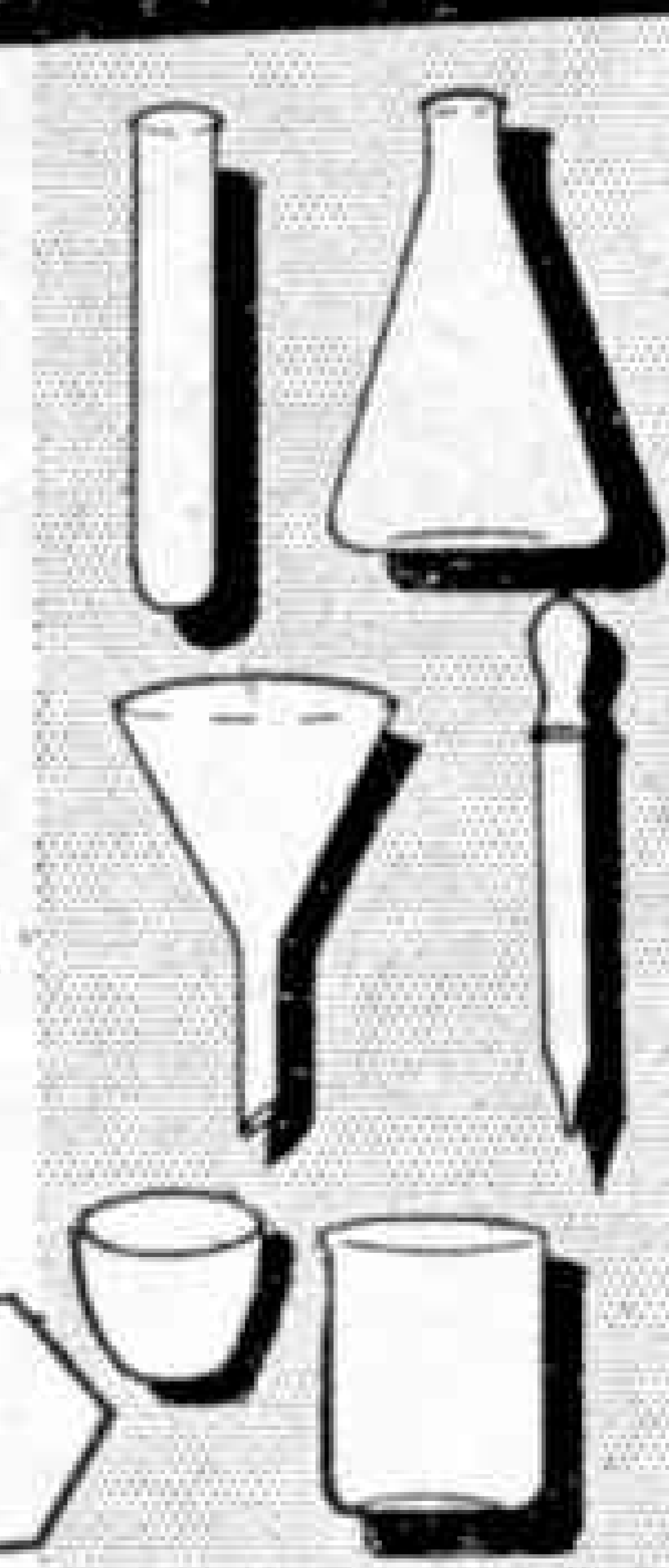

LOTT'S BRICKS LTD (Dept. M.M. 4) WATFORD · HERTS



YOU'LL HAVE
MORE
FUN

WITH

SPEAR'S GAMES

AND EVEN DAD
WON'T BE ABLE TO RESIST THEM



CAPPIT: A game for 2-4 players, who try to "Catch and Cap" their opponents. As easy as ludo, but how much more exciting! **9/-**



TELL ME: The queen of quiz games. Spin the wheel and roll out the questions! Endless fun for any age. Any number of players, the very thing for your party. **7/6**

If your dealer cannot supply, write for address of nearest stockist to:

J. W. SPEAR & SONS LTD.
DEPT. M • ENFIELD • MIDDLESEX

You'll
never meet
REG HARRIS...



riding
anything
but

DUNLOP

Now you can take Indoor Photographs with **ANY CAMERA**

By using an ordinary box camera and the Johnson Indoor Photography Outfit you can take splendid indoor snapshots of your family, friends and pet animals. Think of the opportunities for unforgettable pictures.

Happy, natural, homely scenes. Mother darning socks by the fire. Father washing up. Baby brother in his bath. The chances you will have are endless.



THE JOHNSON INDOOR PHOTOGRAPHY OUTFIT

Complete, in box with Torch, Reflector, Batteries, Adaptor, four PF.14 Photoflash bulbs and full instructions. PRICE (inc. P.T.) only **10'8**

From all Photographic Dealers

JOHNSONS OF HENDON LTD., LONDON N.W.4

Mamod

MODEL S.E.2 STEAM ENGINE

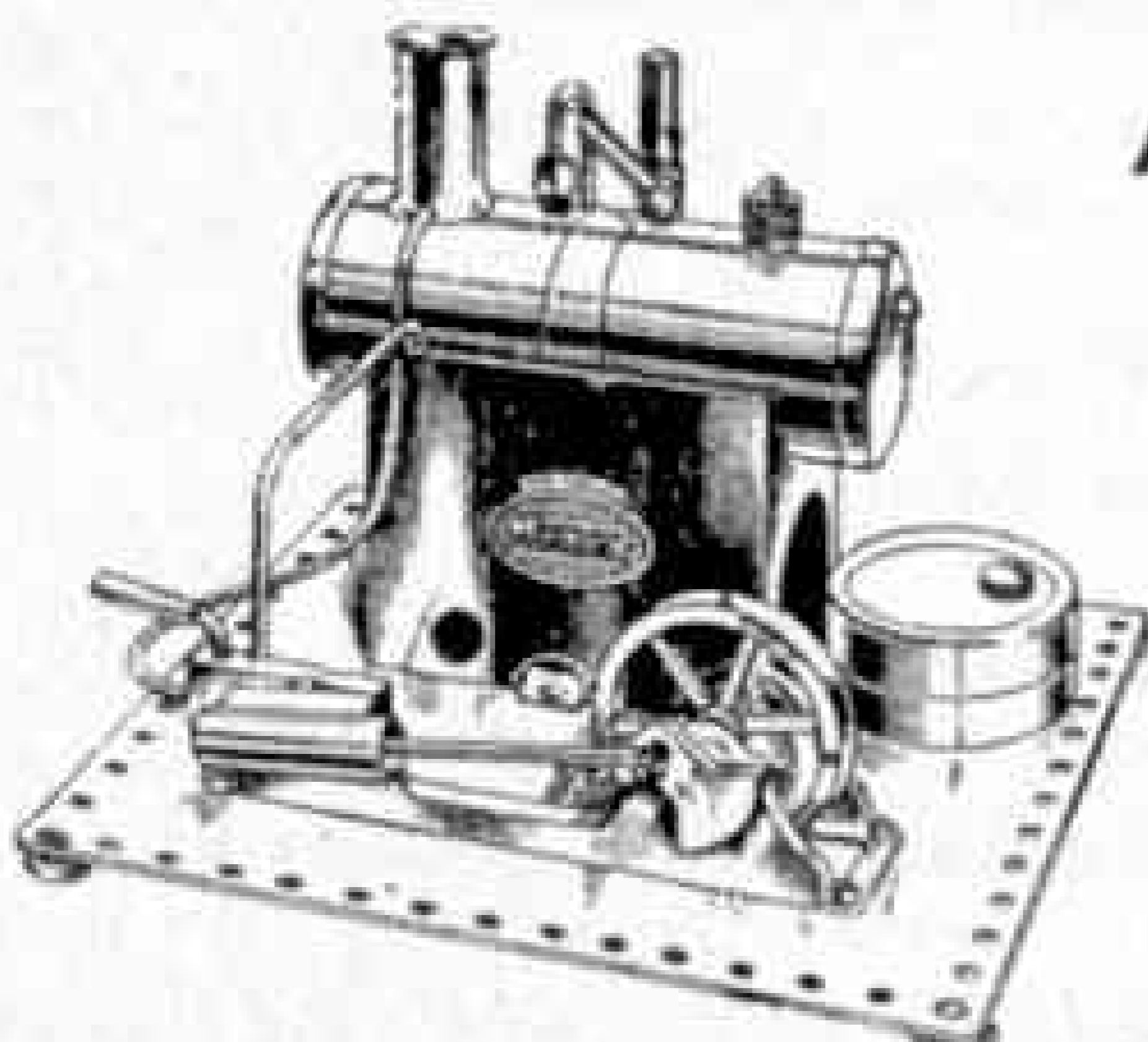

A magnificent
miniature
power plant
for driving
your models

52'6

inc. Purchase Tax

This splendid model is fitted with seamless highly polished brass tube boiler 5" long, speed regulator, whistle, 2" diameter red spoked-brass flywheel and safety valve, beautifully finished in red, green and black, and complete with filler funnel, three burner spirit lamp and full instructions.

MAMOD MINOR No. 1 STEAM ENGINE **23'6** inc. Tax
MAMOD MINOR No. 2 STEAM ENGINE **32'6** inc. Tax
MAMOD S.E.1 STEAM ENGINE ... **42'6** inc. Tax

**ALL MAMOD ENGINES AND WORKING MODELS
FIT MECCANO AND ARE 100% GUARANTEED**

Be sure to ask your dealer to show you this famous range.

**MALINS (ENGINEERS) LIMITED
25-31, CAMDEN STREET, BIRMINGHAM 1**

Build a **TABLE-TOP Railway Layout**

GAUGE '000'
SCALE 2 mm.

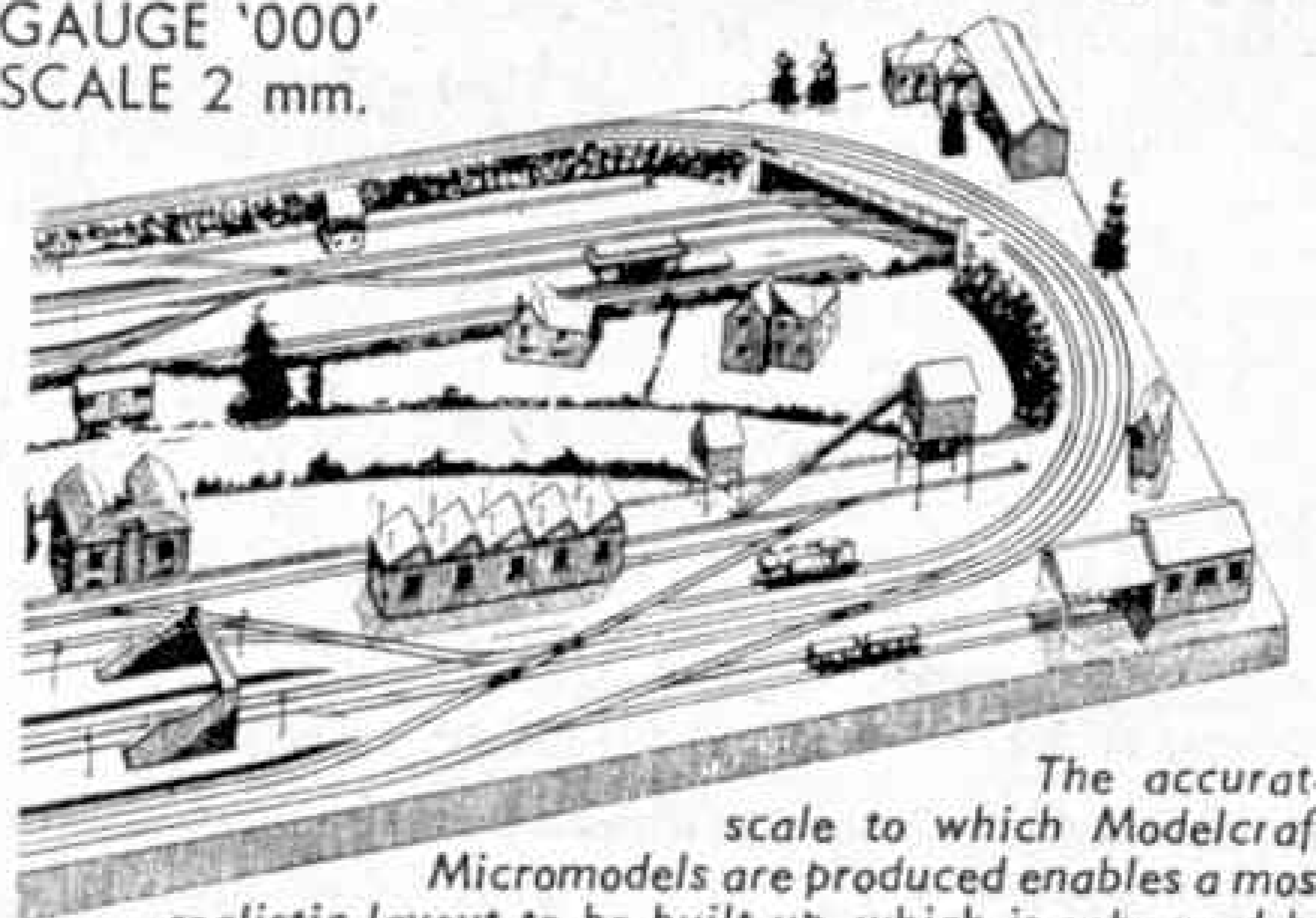

The accurate scale to which Modelcraft Micromodels are produced enables a most realistic layout to be built up, which is enhanced by the addition of trees, bushes, etc., from the 'Treemaker' Kit.

- **MICROMODEL TRACK CARDS**
Full colour, each approx. 10" of double track. Order Straight, Curves or crossovers. ... each **2½d.**
- **'TREEMAKER' KIT**
To make trees, bushes, shrubs, etc., to scale. **3'1**
- **MICROMODEL "ROLLING STOCK"**
L.N.E.R. "Flying Scotsman," "Sandringham," Tank Loco. L.M.S. "Princess Royal," Diesel-Electric, S.R. "Lord Anson," "Channel Packet," etc. S.R. Passenger Coaches (2) Goods Wagons (not coldr.) (5)

**each
4d.**

**6d.
6d.**

AT YOUR LOCAL MODEL SHOP or from

MODEL-CRAFT

77 (H), Grosvenor Rd., London S.W.1
Postage: 1d. in 1/- Minimum 3d.

WILSON'S LORRIES LTD.

Dept. M

6, Gt. Winchester St., London E.C.2

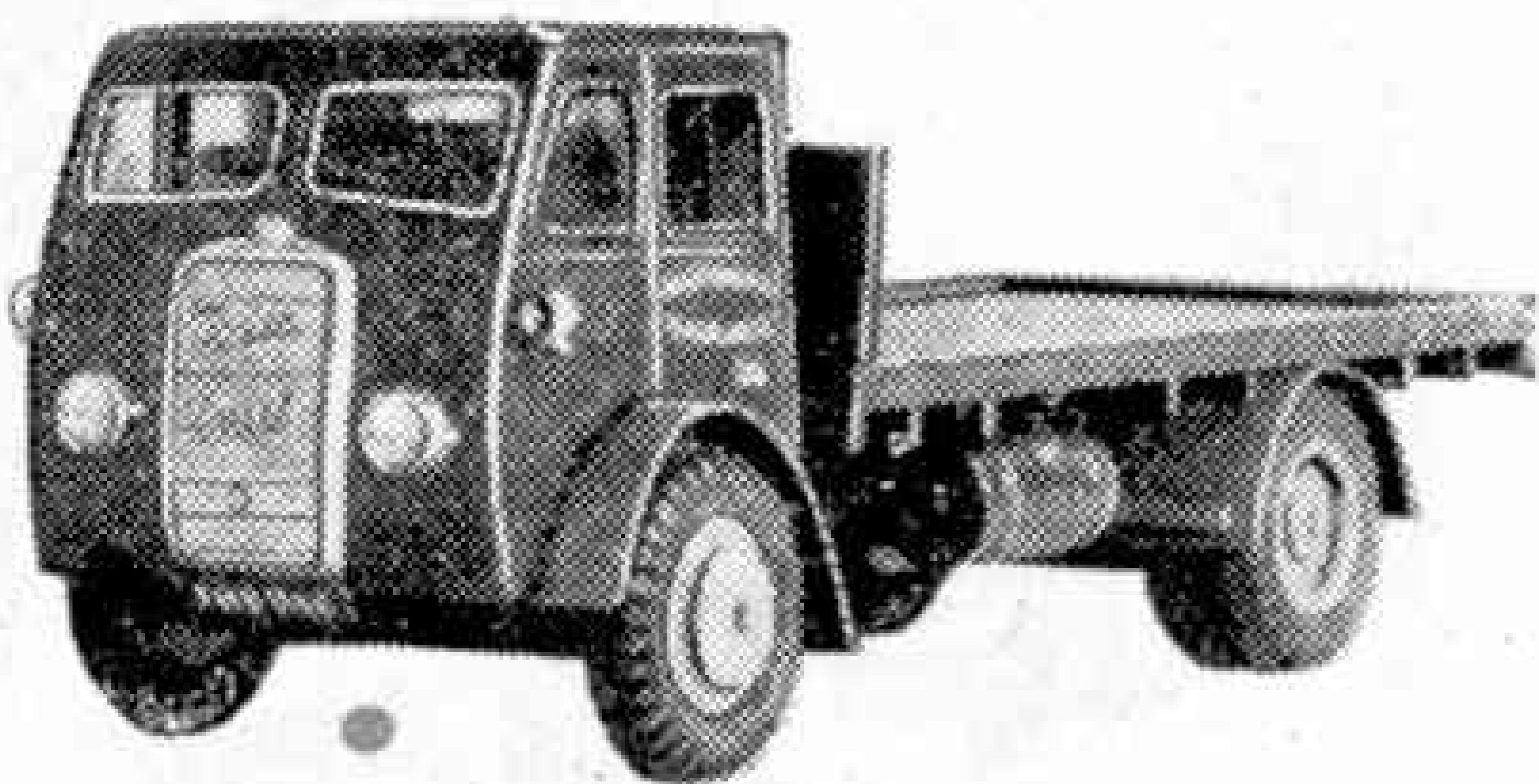

BUILD YOUR OWN

4 mm. and 7 mm. lorry kits

Send for

ILLUSTRATED CATALOGUE

8d. post free

24 "no-tools-to-make-em" outfits
and a host of Spare Parts

Jan Allan RAILWAY BOOKS

The 1952 Locomotive A.B.C.	
4 Regions	each 2/2
The 1952 Locoshed Book ..	Complete 2/8
A.B.C. of B.R. Locos. (Combined	
Volume)	10/-
Trains Annual	10/-
Boys' Book of B.R.	10/-
London's Underground	13/-
London's Underground in Pictures ..	2/8
Service Suspended	2/8
Buses Illustrated—No. 9 (Jan. 1952) ..	2/8
A.B.C. of London Transport Buses ..	2/8

LOCOMOTIVE PUBLICATIONS

32, APPROACH RD., LONDON BDG., S.E.1

CHEMISTRY APPARATUS



Send 2½d. Stamp
for latest

PRICE LIST

BOOKLETS:

- "Experiments" 10½d.
 - "Formulas" 10½d.
 - "Home Chemistry" 2/3
- Post Paid

BECK (Scientific Dept. G), 60, High Street
STOKE NEWINGTON, LONDON N.16

THIS IS IT CHAPS!

A SUPER SHEFFIELD SHEATH KNIFE

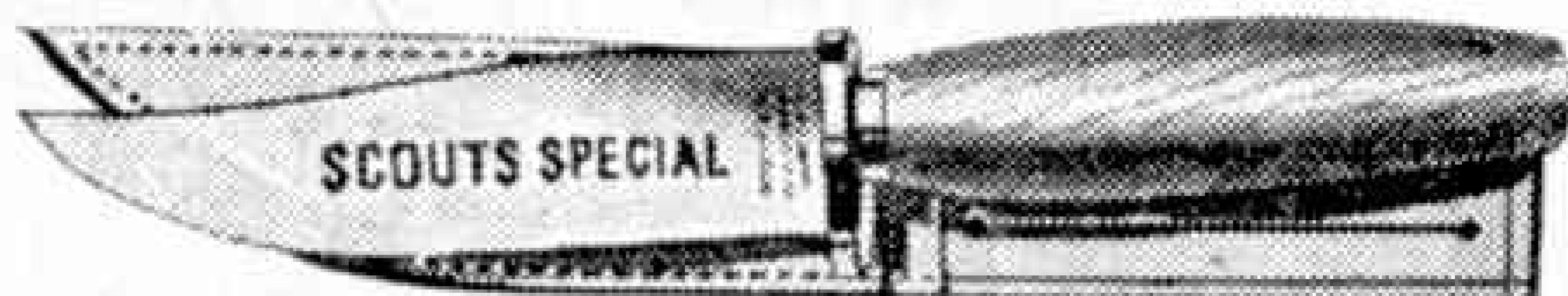

8 INCHES LONG from the tip of its hand-ground, razor-edged Sheffield steel blade to the top of its polished wood handle; complete with leather sheath. Also finest hand-made Hunting Knives with brass decorated leather handles and polished metal hilts: 6" - 9/4; 8" - 13/3; 9" - 18/-, all including leather sheath.

CRAFTSMAN-MADE BY WILLIAM RODGERS

Robin's
MAIL-ORDER SERVICE

DON'T MISS IT!

Post and packing on
all knives 8d. extra.

5/4

(Dept. M.252), 100, EAST STREET, LONDON S.E.17

WEBLEY AIR PISTOLS

Marvellously
accurate for
target practice



No licence required to purchase
for use on enclosed premises.

Senior

Mark 1

Junior

Webley Air Rifle

Write for list. **WEBLEY & SCOTT LTD.**,
87, Weaman Street, Birmingham, Eng.

W.S.5.R.

THE BOOK OF POWER

By Joseph Lawrence

"... written specially to provide young readers with fascinating glimpses of some of the marvels of modern engineering... Excellent colour plates." **Meccano Magazine**. 5s. net

Of absorbing interest to all boys.

FREDERICK WARNE & CO. LTD.
1, BEDFORD COURT, LONDON W.C.2

PERSONAL ATTENTION MEANS A LOT TO THE MODELLER

We have the largest stock of model materials, aircraft and railway kits and accessories in the North. Your mail order by return. Send 4d. stamp for eight-page list.

WILMSLOW MODEL CO.

Water Lane, **WILMSLOW**, Cheshire

CIGARETTE CARDS

Send 6d. for CATALOGUE of 1,000 different series. Special offer 100 different cards 2/9. Albums to hold 200 cards 1/9½.
Dept. "M." E.H.W. Ltd., 42, Victoria St., London S.W.1

PREPARED TIMBER

This is good quality timber of smooth finish ready for use.

Obechi in 3 ft. lengths

$\frac{1}{4}$ in. x $\frac{1}{4}$ in.	3½d.	$\frac{1}{4}$ in. x $\frac{1}{2}$ in.	6d.
$\frac{1}{2}$ in. x $\frac{1}{4}$ in.	3½d.	$\frac{3}{8}$ in. x $\frac{1}{2}$ in.	7½d.
$\frac{3}{8}$ in. x $\frac{1}{2}$ in.	5½d.	$\frac{1}{2}$ in. x $\frac{1}{2}$ in.	7½d.
$\frac{1}{2}$ in. x $\frac{3}{8}$ in.	6d.	1 in. x $\frac{1}{2}$ in.	10½d.
1 in. x $\frac{1}{4}$ in.	7½d.	$1\frac{1}{2}$ in. x $\frac{1}{2}$ in.	1/2
$1\frac{1}{2}$ in. x $\frac{1}{2}$ in.	10½d.	2 in. x $\frac{1}{2}$ in.	1/9
2 in. x $\frac{1}{4}$ in.	1/2	3 in. x $\frac{1}{2}$ in.	2/4½
3 in. x $\frac{1}{4}$ in.	1/9	6 in. x $\frac{1}{2}$ in.	4/-
6 in. x $\frac{1}{8}$ in.	3/-	$\frac{1}{2}$ in. x $\frac{1}{2}$ in.	10½d.

Birch in 3 ft. lengths

$\frac{1}{8}$ in. x $\frac{1}{2}$ in.	2d.	$\frac{1}{8}$ in. x 2 in.	9d.
$\frac{1}{8}$ in. x $\frac{1}{2}$ in.	3d.	$\frac{1}{8}$ in. x 3 in.	1/-
$\frac{1}{8}$ in. x 1 in.	5d.		

Resin Bonded Plywood

$\frac{1}{8}$ in. x 20 in. x 35 in.	..	7/- per sheet
$\frac{1}{8}$ in. x 12 in. x 50 in.	..	5/6 per sheet

Packing and Postage Extra.

Minimum Charge 11d.

BOND'S O' EUSTON ROAD LTD.

357, EUSTON ROAD, LONDON N.W.1.

Est. 1887.

'Phone: EUSTON 5441-2

3 SUPER NEW FAGAN KNIVES

Wear any (or all!) of these wonderful new knives from your belt!



1. A strong Sheath Knife of the best Sheffield Steel, with a sharp cutting blade five inches long. Black and gold handle. Needle-sharp point. Only 21/- (packing and postage 9d. extra).



2. Miniature Sheath Knife; exactly like the above knife; but with a 3-inch blade and 3-inch handle. Only 13/11 (packing and postage 9d. extra).

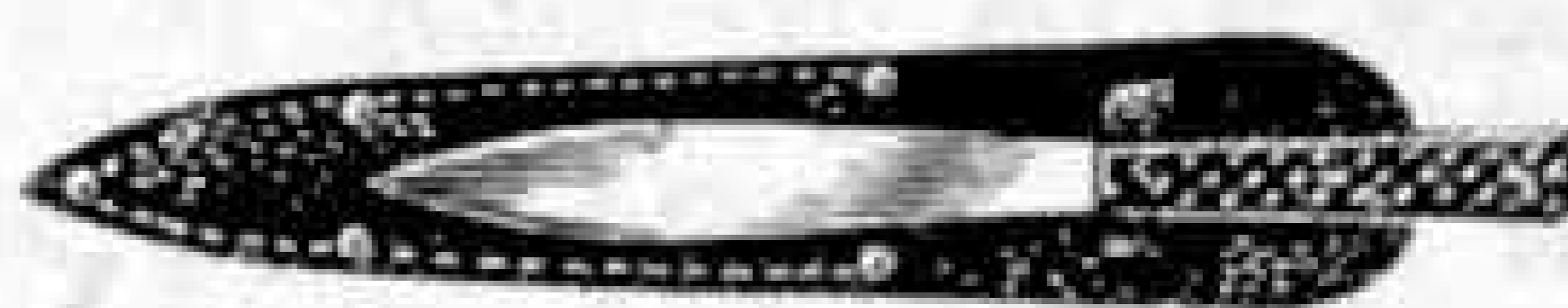

3. "Throwing" Knife—neat and deadly, quick on the draw. Of the best Sheffield Steel. In a black sheath. Only 8/6 (packing and postage 7d. extra).

These knives make presents—ask for them! Or write off today for any of these knives (enclosing a P. O.).

Hamleys
ESTD. 1760
HAMLEY BROTHERS LTD

200-202 REGENT STREET, LONDON, W.C.1

Our Only Address

'Phone: REG 3161.

The Latest!

SPARKS' DATA SHEETS

Shows how you can Build a Really Fine Radio of which you will be Proud and Thrilled by the results.

JUST RELEASED "THE MIDDY"

A Smashing 2-Valve All-dry Battery Set for outstanding Loudspeaker or 'Phone results on M.W. and L.W. (British and Continental, plus "Ship-to-Shore" Transmissions) with a short aerial. The Ideal Set for your Den, Camp or College. Easy and inexpensive to build. REMEMBER Sparks' Constructional Data Sheets are the Finest obtainable. Every detail is so clear that you cannot go wrong, as many thousands of satisfied clients have proved. The Full-size Data Sheet, with descriptive matter, for the "Middy" is only 3/- plus 2½d. Stamp.

MANY OTHER DESIGNS AVAILABLE, SEND STAMP FOR LATEST LIST

COMPONENTS CAN BE SUPPLIED

SPARKS' DATA SHEETS (MM)

48a, High Street, Swanage, Dorset

LENS OF SUTTON 50, CARSHALTON ROAD, SUTTON, SURREY

Plenty of back numbers always available of "Meccano Magazines" 1930-1941, 9d. each; 1942-1949, 6d.; 1950 onwards, 9d. Also "Model Railway News," "Model Railway Constructor," "Model Engineer," all 6d. each. All "Buses Illustrateds," 1/6 each. "Trains Illustrateds" (Vol. 2—Dec. 1950), 1/- each; 1951 issues, 1/6 each. "Railway Magazines" pre-1942, 2/- each; 1942-date, 1/6. Glossy P.C.'s of Buses, Trams and Locos., 6d. each. Good clean mixed cigarette cards, 50 for 1/-. Sets 1/6. Anything of a Railway nature bought, sold or exchanged.

AMERICAN MAGAZINES

Subscriptions arranged for Popular Science, Model Railroader, Trains, etc. Popular Mechanics books available. S.A.E. Lists: PETER F. HOBSON, DEPT. M.M., 79, SOUTHBROOK ROAD, EXETER

BOOKS:

"00 Layout and Design"	3/6
"I Drove Cheltenham Flyer"	8/6
"New Developments in Railway Modelling" ..	15/-

RAILWAY ACCESSORIES:

	00	0
Fogmen's Huts with Fire	3/-	3/-
Contractors' Huts	3/9	6/6
Bungalows	5/9	9/6
Weighbridge and Office	7/6	—
Tunnels, S/Line	5/-	6/-
Sheet L.M.R. or S.R. Station Signs	7d.	—
Sheet Station Notices	2½d.	7d.
Six Plastic Sacks, assorted	1/2½	1/9
Set Gradient and Mile Posts	3/-	—
Green Hedges	1/-	1/-
Platform Yard Crane	3/9	6/3

Postage extra "00" or "0" Parts List 3d. per post.

TYLDESLEY & HOLBROOK (M.E.T.A.)

109, DEANS GATE, MANCHESTER 3

STUDY AT HOME FOR THE NEW GENERAL CERTIFICATE

OF EDUCATION—the certificate that opens the door to ANY career. It is the hall-mark of a good general education, the first step to a degree, and exempts from most professional prelim. exams. Wolsey Hall (founded 1894) provides efficient postal tuition for the G.C. of E. exams. of London, Oxf., Camb., and the Northern Universities. Moderate fees, instalments. Prospectus (mention exam.) from C. D. Parker, M.A., LL.D., Dept. GK5,

WOLSEY HALL, OXFORD

STAMP ADVERTISEMENTS

(See also pages 88 and 90)

FIJI HEALTHS FREE

IN 1931 New Zealand issued one of its first health sets. It is now valued at £18.

IN 1951 Fiji issued its first health set. The two values are the same as the early N.Z. set. You cannot afford to miss this attractive and probably profitable set. During February only all genuine approval applicants enclosing 2½d. postage will receive the mint set FREE. H. B. LANG, BURNBANK, MAUCHLINE, Ayrshire

1,000 STAMPS 6'6

ALL DIFFERENT. NO GREAT BRITAIN.

500, 3/-, 250, 1/6. 100, 9d.

BRITISH COLS.: 100, 1/3; 200, 3/3; 300, 6/6. TRIANGULARS: 10, 1/6; 25, 4/6; 50, 10/-. RAILWAY ENGINES: 15, 1/3; 25, 2/3; 50, 5/6. FLAGS: 10, 1/3; 25, 2/9. MAPS: 10, 1/3; 25, 2/9. SHIPS: 10, 1/-; 25, 2/3. AIRMAILS: 25, 1/6. POSTAGE 2½d. EXTRA.

Approvals and Catalogue of stamp bargains on request.

S. Tatlow & Sons, Eckington, Sheffield

FOR THIS MONTH ONLY

I offer a really exceptional free gift to introduce my discount approvals—five scarce unused George V

OVERPRINTED WAR STAMPS

issued during 1914/9 War. The stamps are from ANTIGUA (large), MONTSERRAT, MALTA, TRINIDAD and GIBRALTAR. Few collectors have these stamps, which are most uncommon and have a good catalogue value. Please request approvals and enclose 2½d. stamp. H. W. PEARSON, 61, DULVERTON RD., RUISLIP, MIDD.

HOURS OF INTEREST Sorting These Lots! ½ lb. 4 oz.

World asstmt. from many countries (no G.B.) 9/6 5/-

British Empire on paper unsorted as received 12/6 6/6

U.S.A. office mixture with pictorials . . . 5/3 2/9

Australia, Canada, Holland, France or Belgium 6/6 3/6

ex abd. A. Davies (est. 1936), 111, Holme Lacy Rd., Hereford

✦ NEW FALKLAND IS. PICTORIALS FREE! ✦

Send postage for my 50% DISCOUNT APPROVALS. M. Theobald, 6, Dell Corner, West Drayton, Middlesex

BOYS! MAKE MONEY AT HOME
SILK SCREEN PRINTING

Here is a Career and a Hobby YOU CAN START NOW! One of the great new Graphic Arts—so simple that you can start work at once—and yet with unlimited possibilities before you. Silk Screen Printing in Multi-colours and in the new FLUORESCENT PAINTS is in demand everywhere. Our amazing offer below will get you into this great new vocation now, with trade secrets and all the equipment you need to start work at once—as you learn.

BARGAIN OFFER OF NEW JUNIOR OUTFIT!

A complete outfit at pounds below prices elsewhere and including absolutely free a 10/- complete course. Prints in brilliant colours up to 11" x 10". Posters, Notices, Xmas Cards, Plans, Pictures, Wood Toy Parts, etc., etc. Printing Frame, Paints, accessories, everything included. Photo. work sample 1/6 (credited)

ALL FOR 21/-

Post Paid

A. P. SUPPLIES, Sedgeford, King's Lynn, Norfolk

Learn Shorthand by 1st Mar. (1 hour's study nightly). 1st lesson 2½d. stamp. Duttons (Dept. M0). 92, Gt. Russell St., W.C.1

REPLIES TO ADVERTISEMENTS

Our advertisers, Messrs. George Bradshaw, 5 and 6, Western Road, Hove, Sussex, tell us that they have recently received several orders with which no names and addresses have been included. Any reader who has written to this firm, and has not received acknowledgment, should send a copy of his original letter, giving the desired particulars.

Readers who respond to advertisements in the "M.M." should bear in mind the necessity for giving their names and addresses in full in their replies, especially when stamps or postal orders are enclosed. It is also helpful to state that the advertisement concerned appeared in the "M.M."

MECCANO
MAGAZINE

Registered at the G.P.O., London, for transmission by Canadian Magazine Post.

EDITORIAL AND ADVERTISING OFFICES:

LIVERPOOL 13, ENGLAND.

Telegrams: "Meccano, Liverpool."

Readers' Sales and Wants. Private advertisements (i.e., not trade) are charged 1d. per word, minimum 1/-. Cash with order. Readers' advertisements are published as soon as possible; inclusion in the first issue after receiving them cannot be guaranteed.

CRYSTAL SET KITS 15/11 post free. Built in 30 mins. Endless entertainment and no further expense. Headphones 15/-. BUCKLE, 77, Horringer Road, Bury St. Edmunds

READERS' SALES AND WANTS
SALES

Wide range Meccano Spares (separately or in lots); E20R Motor and Transformer. Reasonable prices.—Clark, 46, Windsor Road, Cambridge.

1950 No. 10 Meccano Outfit. Carefully used. Cost £30. Offers—Box "M.M." No. 30.

Hornby Clockwork Train Set. Extra Rails and Trucks. Good condition £6.—Golding, 87, Shorton Valley Road, Paignton.

Complete Drawing Outfit. Used only twice, cost £10, selling at £6. .22 Pellets, 3/6 per 500. "Practical Mechanics" June–August 1949, 4d. each. "Mechanics Illustrated" Nos. 3–10, 1/3 each. "Boy's Own Paper" June–November 1949, 6d. each. Stanley Gibbon Stamp Catalogue 1949 of Central America, U.S.A. and possessions, 2/6. S.A.E. to—D. Tillyer, 74, Greenway, Pinner, Middlesex.

Large collection of Dinky Toys for sale. S.A.E. for list.—Edwards, 509, Binley Road, Coventry.

"M.M.s" January 1943–July 1951 inclusive (December 1945 missing). "Boy's Own Papers" June 1943–July 1951 (December 1943, November 1944, December 1945 and August 1946 missing). All good condition. Best offer.—Campbell, 10, Berkeley Avenue, Chesham, Bucks.

Hornby-Dublo Tank Set. Accessories include L.M.S. Coaches, Rolling Stock, Signals, Points, Rails, Buffers, etc. Hornby 6-volt Electric Transformer, to be bought complete. Send S.A.E. for list.—Ogilvie, 4, Marchmont Terrace, Glasgow W.2.

Hornby Riviera "Blue" Dining Car, as new, complete with corridor connection.—E. Riley, 210, Denton Lane, Chadderton, Nr. Oldham, Lancs.

"M.M.s" January 1942 to date, all in excellent condition. Will sell complete or in separate years. Offers to—Milton, 54, Beech Road, St. Albans, Herts.

Pre-war No. 6 Meccano Outfit with many extras including Clockwork and Electric Motors with Mains Transformer; packed in two wooden cabinets. Can be viewed in Preston. S.A.E. for further particulars.—Rowe, 89, St. George's Drive, London S.W.1.

WANTS

Hornby-Dublo "Sir Nigel Gresley" Locomotive and Tender, good condition and running order. Exchange for "Duchess of Atholl" Locomotive and Tender, similar condition.—Box "M.M." No. 55.

Dinky Toys and Supertoys any condition. Also Trix Trains. S.A.E. for particulars. Will answer all replies. Write—J. F. Tempone, 2621—92nd Street, Jackson Heights, L.I., New York, U.S.A.

Electric or Clockwork Train Set, Accessories or complete Layout.—Lynch, 3, Gordon Drive, Grassendale, Liverpool 19.

"Eagle" comics, Nos. 2 and 20. Clean and in good condition.—Perrin, 9, Bishops Road, London N.6.

Will pay 4d. each for copies of the pre-war series "Boy's Friend Library," "Schoolboy's Own Library," "Sexton Blake Library."—Williams, 3, Crystal Street, Sylvania, N.S.W., Australia.

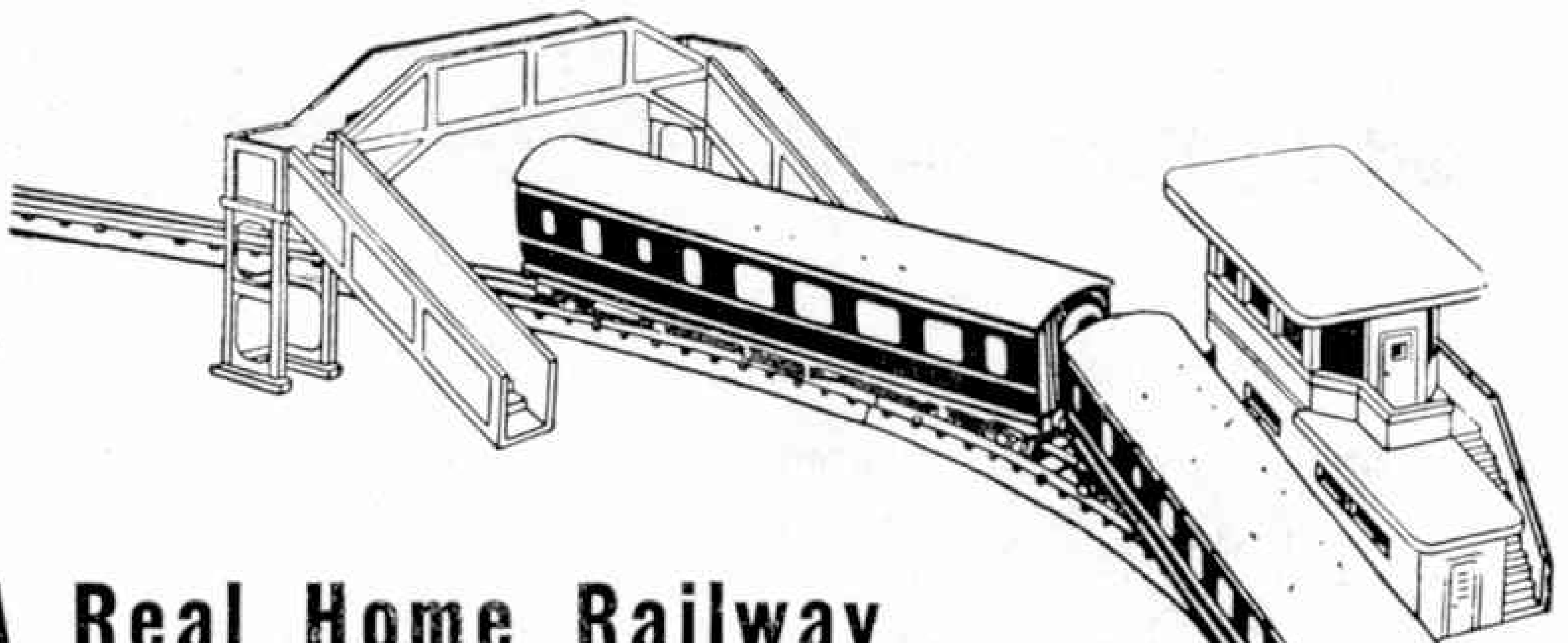

A Real Home Railway

Here is the electric railway you have always wanted . . . simple and safe. Starting, stopping, reversing, and speed regulation of Hornby-Dublo locomotives are all controlled from the lineside by the movement of a single lever.

*Made in England
by Meccano Ltd.*

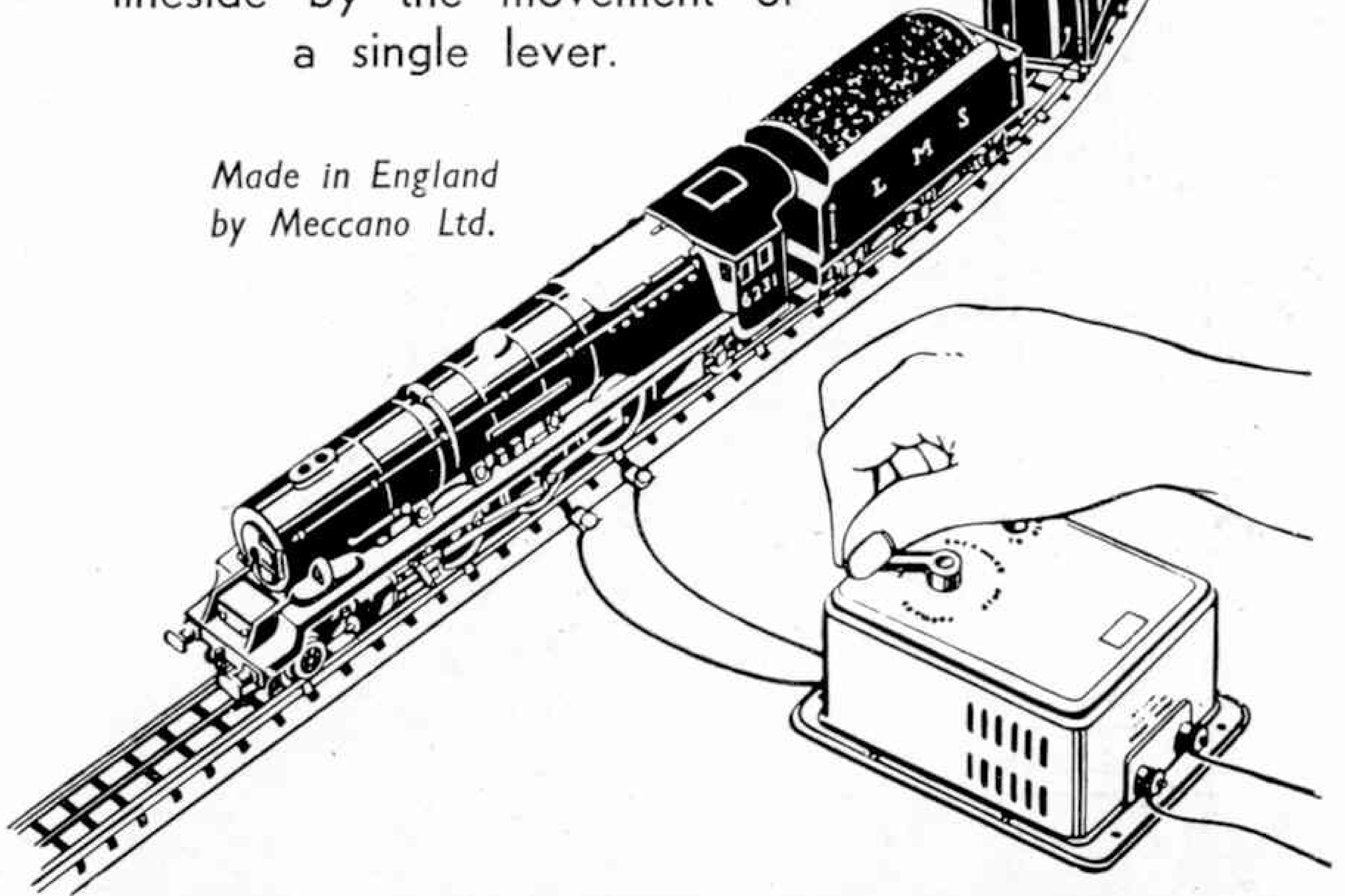

HORNBY-DUBLO

ELECTRIC TRAINS

Another lucky Meccano boy

He's happy—he's absorbed.
He's making a real working
model with Meccano. No
ready-made toy can compete
with Meccano for long and
happy play hours.

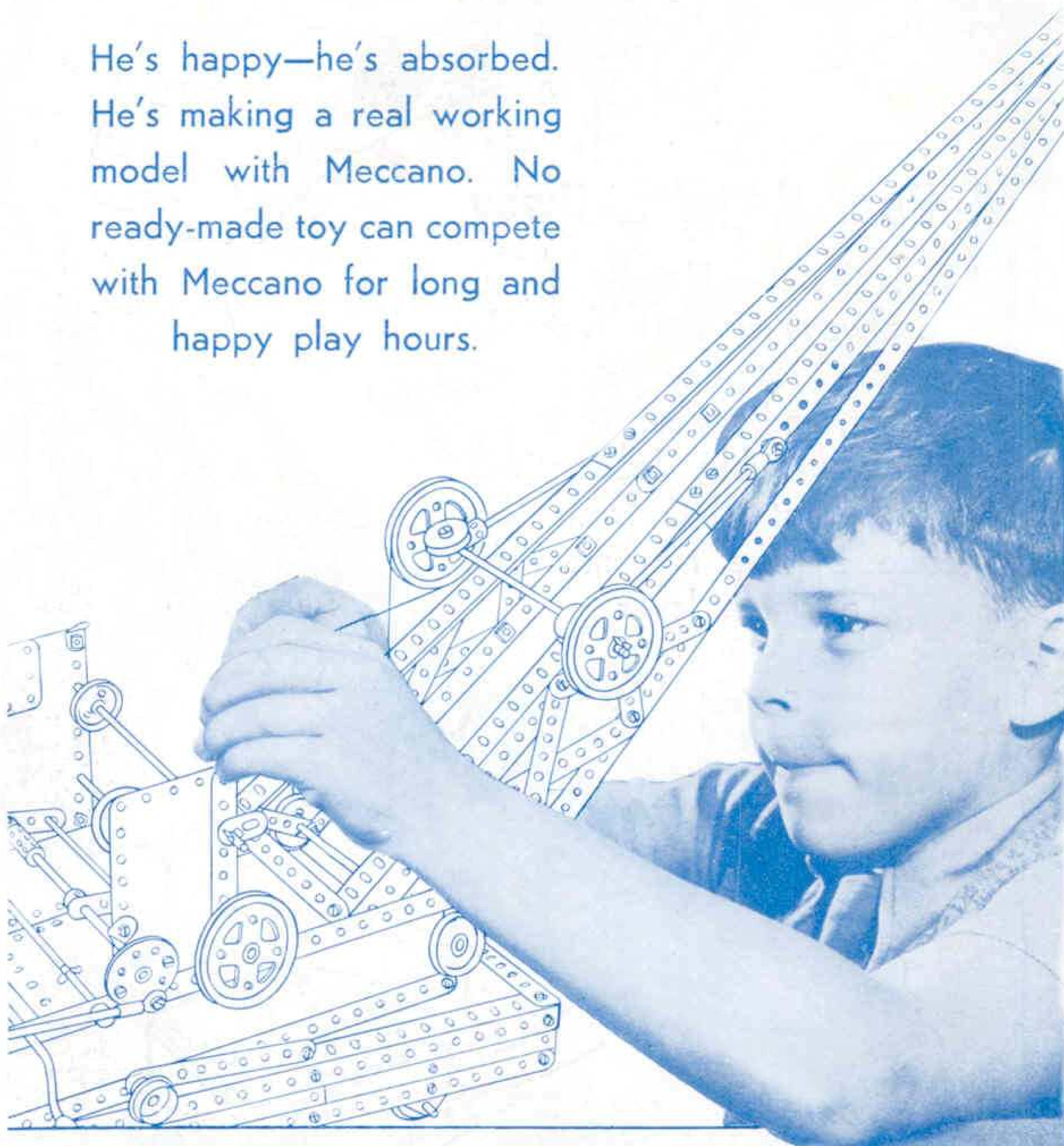

MECCANO

MORE THAN A TOY

MADE IN ENGLAND BY MECCANO LTD